

Performance

Lifting height — on tyres	6331.0 mm
Rated capacity	3400 kg
Capacity (at max. height on tyres)	3400 kg
Capacity (at max. reach on tyres)	1300 kg
Max. reach on tyres	3369.0 mm

Weights

Weight (unladen)	6550 kg
------------------	---------

Traction

Standard tyres	SOLIDEAL 405/70-20 14PR
1st gear / low range (40 km/h option)	6 (6) km/h
1st gear / high range (40 km/h option)	11 (12) km/h
2nd gear / low range (40 km/h option)	16 (18) km/h
2nd gear / high range (40 km/h option)	30 (40) km/h

Drive System

Transmission	Hydrostatic with electronic regulation
Main drive	Hydrostatic motor + 2 speed gearbox

Engine

Make / Model	Bobcat D34
Fuel	Diesel
Cooling	Coolant
Rated power (ISO 14396:2002) at 2400 RPM	130.0 HP
Rated power (ISO 14396:2002) at 2400 RPM	97.0 kW
Maximum torque at 1400 RPM	500.0 Nm
Number of cylinders	4
Displacement	3.40 L

Hydraulic System

Pump type	LS piston pump with electric displacement limiter
Pump capacity	190.00 L/min
Relief valve pressure setting	255.00 bar

Cycle Times

Lift time - no load	4.9 s
Lower time - no load	4.3 s
Telescope in time at max. reach - no load	3.7 s
Telescope in time at max. height - no load	3.7 s
Telescope out time at max. reach - no load	4.0 s
Telescope out time at max. height - no load	3.8 s

Brakes

Engine braking	Hydrostatic
Parking and emergency brake	Passive brake

Fluid Capacities

Fuel tank	138.00 L
Hydraulic reservoir	59.00 L

Environmental

Operator noise level (LpA) (EN 12053)	77 dB(A)
Level of acoustic power (LWA)	107 dB(A)
Whole body vibration (EN 13059)	1.20 ms ⁻²

Load Charts

With forks on 20 inch tyres

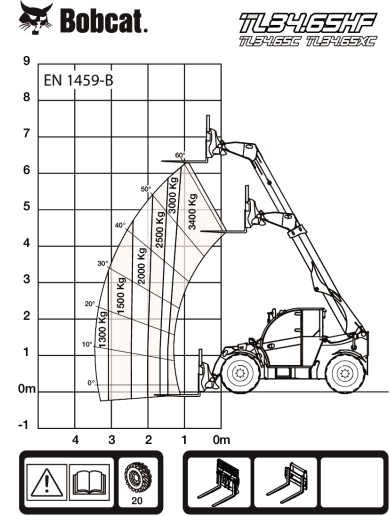
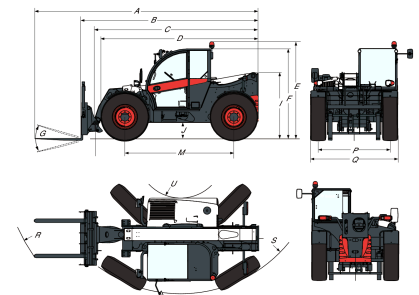
Dimensions

(-) 900.0 mm	(L) 1156.0 mm
(A) 5874.0 mm	(M) 2870.0 mm
(B) 4669.0 mm	(N) 643.0 mm
(C) 4563.0 mm	(O) 1013.0 mm
(D) 4058.0 mm	(P) 1895.0 mm
(E) 2477.0 mm	(Q) 2300.0 mm
(F) 2290.0 mm	(R) 4758.0 mm
(G) 135.0°	(S) 4852.0 mm
(I) 1668.0 mm	(T) 3714.0 mm
(J) 346.0 mm	(U) 1092.0 mm