

KOMATSU

PC
290

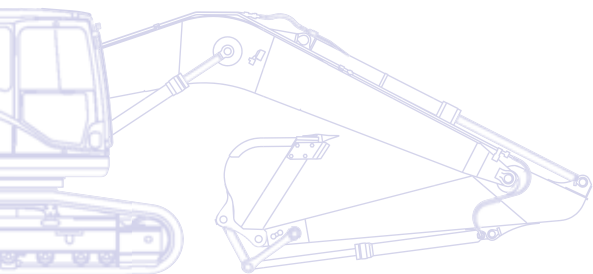

Hydraulic Excavator **PC290LC/NLC-8**



ENGINE POWER

149 kW / 200 HP @ 2.050 rpm

OPERATING WEIGHT

PC290LC-8: 29.710 - 31.090 kg

PC290NLC-8: 29.610 - 30.990 kg

BUCKET CAPACITY

max. 2,02 m³

Walk-Around

The Komatsu Dash 8 crawler excavators set new worldwide standards for construction equipment. Operator safety and comfort is a focal point in their design, and their outstanding performance and specifications will contribute directly to the success of your business. With standard auxiliary hydraulic systems and quick-coupler power lines, these machines are ready to take on any job, whenever and wherever you need it done. Safely rely on Komatsu's 80 years of experience and commitment to Quality and Durability: your Dash 8 crawler excavator will quickly become your number one business partner.

Powerful and environmentally friendly

- Low consumption ecot3 engine
- Komatsu integrated hydraulic system
- Eco-gauge and idle caution
- Reduced wastage

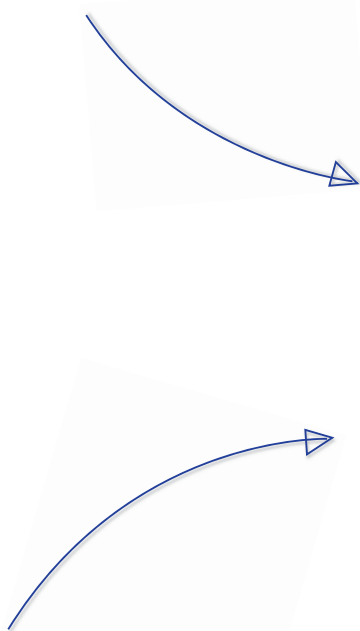

Total versatility

- Ideal for a wide range of applications
- 5 working modes
- Wide choice of options
- Built-in versatility



PC290-8

ENGINE POWER
149 kW / 200 HP @ 2.050 rpm

OPERATING WEIGHT
PC290LC-8: 29.710 - 31.090 kg
PC290NLC-8: 29.610 - 30.990 kg

BUCKET CAPACITY
max. 2,02 m³

Highest safety standards

- Safe SpaceCab™
- Rear view camera
- Optimal jobsite safety
- Safe access, easy maintenance
- Falling Object Protection System (FOPS) optional



First-class operator comfort

- Wide, spacious cab
- Low noise design
- Low vibration levels
- Pressurised cab
- Large, widescreen TFT monitor panel



KOMTRAX

Komatsu Satellite
Monitoring System

Quality you can rely on

- Reliable and efficient
- Rugged design
- Komatsu-quality components
- Extensive dealer support network

Total Versatility

Ideal for a wide range of applications

Powerful and precise, the Komatsu PC290-8 is equipped to efficiently carry out any task your business requires. On big sites or small, for digging, trenching, landscaping or site preparation, the Komatsu original equipment hydraulic system always ensures maximum productivity and control.

5 working modes

Power, Lifting, Breaker, Attachment, and Economy.

The PC290-8 features 5 selectable working modes that optimise performance and fuel usage. The Economy mode can be adjusted for an ideal balance between power and economy to match your work. The oil flow delivered to hydraulic attachments is adjustable directly on the class-leading wide screen monitor panel.

Built-in versatility

To allow the use of many attachments, such as buckets, breakers or demolition tools, a power supply for a hydraulic quick coupler with adjustable pressure settings, and an additional hydraulic circuit controlled by a foot pedal and a sliding joystick push button are standard on the PC290-8. A second optional auxiliary line is also available for attachments that require extra hydraulic actuation.

A wide choice of options

With a choice of different styles of boom, arm and undercarriage, you can configure the PC290-8 to match specific demands for transport, working envelope or duty. Extra hydraulic arrangements are available for every boom and arm configuration, making sure that the machine always contributes strongly to your business.





Powerful and Environmentally Friendly

Low consumption ecot3 engine

The Komatsu SAA6D107E-1 engine provides high torque, a better performance at low speed and low fuel consumption. This ecot3 engine features a new combustion chamber design with optimised ignition and combustion timing. The operating pressure of the new common rail system was increased for improved injection and fuel efficiency. The air-to-air charge cooler reduces the temperature of the compressed air supplied by the turbo charger to the cylinders, and further improves fuel consumption.

Meets EU Stage IIIA

The new Komatsu ecot3 engine technology reduces NOx and particle emissions, fuel consumption and noise level. The Komatsu SAA6D107E-1 engine is certified for EPA Tier III and EU Stage IIIA emission regulations. To further reduce the machine's emissions, a Diesel Particulate Filter is also available.

Komatsu integrated hydraulic system

The PC290-8 is a highly responsive and productive machine with all major hydraulic parts designed and manufactured by Komatsu. The electronic Closed Load Sensing hydraulic System (CLSS) offers complete control during individual or combined movements – without sacrificing performance or productivity.

Eco-gauge and idle caution

The unique ECO-gauge helps the operator reduce emissions and fuel consumption for environmentally friendly and energy saving operations. And to further avoid wasting fuel when the machine is not actually working, a standard-fit idle caution is displayed if the engine idles for 5 minutes or more.

Komatsu SAA6D107E-1



Eco-gauge



Idle caution





Reduced wastage

To avoid spillage of excess grease – and prolong the life of your machine – the PC290-8 can be equipped with an automatic greasing system that provides precisely the correct amount of grease when and where it's required.



First-Class Operator Comfort

Wide spacious cab

The newly designed, wide and spacious cab includes a heated air suspension seat with a reclining backrest. The seat height and longitudinal inclination are easily adjusted with a pull-up lever. You can also set the operational posture of the armrest and the position of the console or recline the seat all the way and place it into a fully flat state with the headrest attached.

Pressurised cab

An automatic air conditioner, an air filter and a positive internal air pressure (60 Pa) combine to prevent external dust from entering the cab.

Low noise design

Komatsu Dash 8 crawler excavators feature the lowest in-class external noise levels and are especially well-suited for work in confined spaces or urban areas. Reduced fan speed, a large capacity radiator, and the optimal usage of sound insulation and of sound absorbing materials help to make noise levels inside Dash 8 excavators comparable to those inside an executive car.

Cab damper mounting

The built-in stability of the Komatsu PC290-8, combined with a highly rigid deck and a sprung multi-layer viscous mount system, drastically reduces vibration levels for the operator.



Automatic air conditioner



Hot and cool box



Joysticks with proportional control button for attachments





Large, widescreen TFT monitor

To enable safe, accurate and smooth work, the user friendly monitor is the highly intuitive user interface for the machine's Equipment Management and Monitoring System (EMMS). Multilingual and with all essential information available at a glance, it features simple and easy to operate switches and multifunction keys that provide the operator with fingertip access to a wide range of functions and operating information.





Highest Safety Standards

Safe SpaceCab™

Specifically designed for Komatsu excavators, the Dash 8 cab has a tubular steel frame. It provides very high shock absorbency, impact resistance and durability. The seat belt is designed to keep the operator in the safety zone of the cab in the event of a roll-over. At your request, the Komatsu PC290-8 can also be fitted with an ISO 10262 Level 2 Falling Object Protective System (FOPS).

Safe and easy maintenance

Thermal guards are placed around high temperature parts of the engine. The fan belt and pulleys are well protected and in case of damage, fire risk is reduced by a pump/engine partition that prevents hydraulic oil from spraying onto the engine.

Optimal job site safety

Safety features on the Komatsu PC290-8 comply with the latest industry standards and work together as a system to minimise risks to personnel in and around the machine. An audible travel alarm further promotes job site safety. Very durable anti-slip plates – with additional high friction covering – maintain long term traction performance.

Rear view camera

A standard fitment camera gives an exceptionally clear view of the rear work zone on the wide-screen monitor panel. Large mirrors on both sides ensure that machine visibility meets the latest ISO standards.



Rear view camera

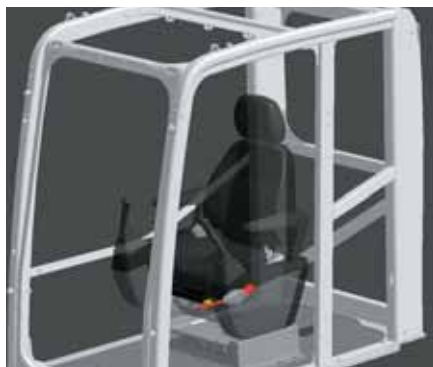

Safe SpaceCab™



Anti-slip plates





Quality You Can Rely On

Reliable and efficient

Productivity is the key to success – all major components of the PC290-8 are designed and directly manufactured by Komatsu. Essential machine functions are perfectly matched for a highly reliable and productive machine.

Rugged design

Maximum toughness and durability – along with top class customer service – are the cornerstones of Komatsu's philosophy. Single piece plates and castings are used in key areas of the machine's structure for good load distribution. Highly durable rubbing strips on the underside of the arm protect the structure from material falling from the bucket.

Komatsu-quality components

With the latest computer design techniques and a thorough test programme, Komatsu's global know-how produces machines that are designed, manufactured and tested to meet your highest standards.

Extensive dealer support network

The extensive Komatsu distribution and dealer network is standing by to help keep your fleet in optimum condition. Customised servicing packages are available, with express availability of spare parts, to make sure that your Komatsu will continue to perform at its peak.



Cast boom foot



Single piece boom plates



Komatsu Satellite Monitoring System



KOMTRAX™ is a revolutionary machine tracking system designed to save you time and money. You can now monitor your equipment anytime and anywhere. Use valuable machine data received via the KOMTRAX™ web site to optimise your maintenance planning and machine performances.

KOMTRAX™ can assist you with:

Full machine monitoring

Get detailed operation data to know when your machines are used and how productive they are.

Total Fleet Management

Keep track of the location of your machines at all times and discourage unapproved usage or theft.

Complete machine status

Receive warnings, alerts and cautions, via a web site or by e-mail, to help with maintenance planning and for longer machine life.

For further details on KOMTRAX™, please ask your Komatsu dealer for the latest KOMTRAX™ brochure.





Machine working time - With the "daily working record" chart, get precise engine running time data: when your machine was started and when it was shut down, as well as total engine running time.



Maintenance planning - To increase productivity and improve maintenance planning, alerts indicate when items such as filters or oil must be replaced.



Fleet location - The machine list instantly locates all your machines, even those in other countries.



Machine tracking during transport - When your machine is transported, KOMTRAX™ sends travel messages to the web site or by e-mail to inform you of its progress, and confirms when it reaches its destination.



Alarm notifications - You can receive notification of alarms both via the KOMTRAX™ website and by e-mail.



Added security - The "engine lock" feature allows to program when a machine's engine can be started. And with "geo-fence", KOMTRAX™ sends notification every time your machine moves in or out of a predetermined operating area.



Easy Maintenance

Side-by-side cooling

Since the radiator, aftercooler and oil cooler are arranged in parallel, it is easy to clean, remove and install them.



Easy access to the engine oil filter and fuel drain valve

The engine oil filter and fuel drain valve are mounted remotely to improve accessibility.



Gas-assisted engine hood damper cylinders

The engine hood can be easily opened and closed with help of the gas-assisted engine hood damper cylinders.



Water separator

This is standard equipment which removes any water that has become mixed with the fuel, preventing fuel system damage.



Washable floor

The floor is easy to keep clean. The gently inclined surface has a flanged floormat and drainage holes to facilitate runoff.

Inclined track frame

The track frame is sloped so that dirt will not accumulate and can be removed easily.

Long-life oil filters

The hydraulic oil filter uses high-performance filtering material for long element replacement intervals, which significantly reduces maintenance costs.



Flexible warranty

When you purchase Komatsu equipment, you gain access to a broad range of programmes and services that have been designed to help you get the most from your investment. For example, Komatsu's Flexible Warranty Programme provides a range of extended warranty options on the machine and its components. These can be chosen to meet your individual needs and activities. This programme is designed to help reduce total operating costs.



ENGINE

Model	Komatsu SAA6D107E-1
Type	Common rail direct injection, water-cooled, emissionised, turbocharged, after-cooled diesel
Engine power	
at rated engine speed	2.050 rpm
ISO 14396	149 kW / 200 HP
ISO 9249 (net engine power)	140 kW / 188 HP
No. of cylinders	6
Bore x stroke	107 x 124 mm
Displacement	6,69 ltr
Battery	2 x 12 V/140 Ah
Alternator	24 V/60 A
Starter motor	24 V/5,5 kW
Air filter type	Double element type with monitor panel dust indicator and auto dust evacuator
Cooling	Suction type cooling fan with radiator fly screen

HYDRAULIC SYSTEM

Type	HydrauMind. Closed-centre system with load sensing and pressure compensation valves
Additional circuits	Depending on the specification up to 2 additional circuits can be installed
Main pump	2 variable displacement piston pumps supplying boom, arm, bucket, swing and travel circuits
Maximum pump flow	2 x 225 ltr/min
Relief valve settings	
Implement	380 bar
Travel	380 bar
Swing	295 bar
Pilot circuit	33 bar

UNDERCARRIAGE

Construction	X-frame centre section with box section track frames
Track assembly	
Type	Fully sealed
Shoes (each side)	48
Tension	Combined spring and hydraulic unit
Rollers	
Track rollers (each side)	8
Carrier rollers (each side)	2

OPERATING WEIGHT (APPR.)

	MONO BOOM				TWO-PIECE BOOM			
	PC290LC-8		PC290NLC-8		PC290LC-8		PC290NLC-8	
Triple grouser shoes	Operating weight	Ground pressure	Operating weight	Ground pressure	Operating weight	Ground pressure	Operating weight	Ground pressure
600 mm	29.710 kg	0,53 kg/cm ²	29.610 kg	0,53 kg/cm ²	30.090 kg	0,54 kg/cm ²	29.990 kg	0,54 kg/cm ²
700 mm	30.110 kg	0,46 kg/cm ²	30.010 kg	0,46 kg/cm ²	30.490 kg	0,47 kg/cm ²	30.390 kg	0,47 kg/cm ²
800 mm	30.510 kg	0,41 kg/cm ²	30.410 kg	0,41 kg/cm ²	30.890 kg	0,41 kg/cm ²	30.790 kg	0,41 kg/cm ²
850 mm	30.710 kg	0,39 kg/cm ²	30.610 kg	0,39 kg/cm ²	31.090 kg	0,39 kg/cm ²	30.990 kg	0,39 kg/cm ²

Operating weight, including 2,65 m arm, 1.300 kg bucket, operator, lubricant, coolant, full fuel tank and the standard equipment.

SWING SYSTEM

Type	Axial piston motor driving through planetary double reduction gearbox
Swing lock	Electrically actuated wet multi-disc brake integrated into swing motor
Swing speed	0 - 10,5 rpm
Swing torque	88 kNm
Max. pressure	295 bar

DRIVES AND BRAKES

Steering control	2 levers with pedals giving full independent control of each track
Drive method	Hydrostatic
Travel operation	Automatic 3-speed selection
Gradeability	70%, 35°
Max. travel speeds	
Lo / Mi / Hi	3,0 / 4,1 / 5,5 km/h
Maximum drawbar pull	25.400 kg
Brake system	Hydraulically operated discs in each travel motor

SERVICE REFILL CAPACITIES

Fuel tank	400,0 ltr
Radiator	20,6 ltr
Engine oil	23,1 ltr
Swing drive	8,2 ltr
Hydraulic tank	132,0 ltr
Final drive (each side)	8,5 ltr

ENVIRONMENT

Engine emissions	Fully complies with EU Stage IIIA and EPA Tier III exhaust emission regulations
Noise levels	
LwA external	104 dB(A) (2000/14/EC Stage II)
LpA operator ear	70 dB(A) (ISO 6396 dynamic test)
Vibration levels (EN 12096:1997)*	
Hand/arm	≤ 2,5 m/s ² (uncertainty K = 0,37 m/s ²)
Body	≤ 0,5 m/s ² (uncertainty K = 0,17 m/s ²)

* for the purpose of risk assessment under directive 2002/44/EC, please refer to ISO/TR 25398:2006.

Dimensions & Performance Figures

MACHINE DIMENSIONS	PC290LC-8	PC290NLC-8
A Overall width of upper structure	2.710 mm	2.710 mm
B Overall height of cab	3.180 mm	3.180 mm
C Overall length of basic machine	5.380 mm	5.380 mm
D Tail length	2.905 mm	2.905 mm
Tail swing radius	2.940 mm	2.940 mm
E Clearance under counterweight	1.215 mm	1.215 mm
F Machine tail height	2.575 mm	2.575 mm
G Ground clearance	498 mm	498 mm
H Tumbler centre distance	4.030 mm	4.030 mm
I Track length	4.955 mm	4.955 mm
J Track gauge	2.590 mm	2.390 mm
K Track shoe width	600, 700, 800, 850 mm	600, 700, 800, 850 mm
L Overall track width with 600 mm shoe	3.190 mm	2.990 mm
Overall track width with 700 mm shoe	3.290 mm	3.090 mm
Overall track width with 800 mm shoe	3.390 mm	3.190 mm
Overall track width with 850 mm shoe	3.440 mm	3.240 mm

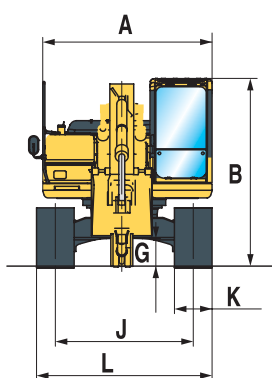

MONO BOOM

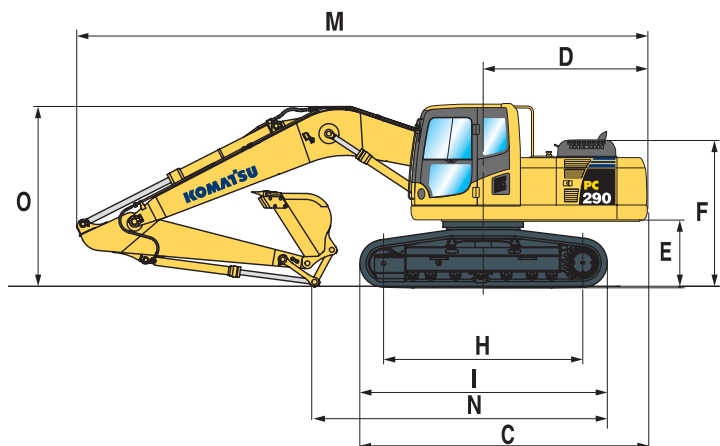

TWO-PIECE BOOM

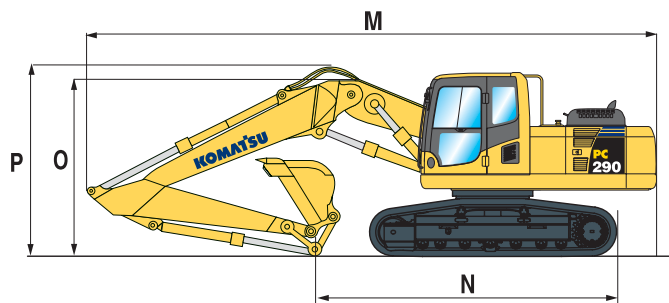

TRANSPORT DIMENSIONS	MONO BOOM				TWO-PIECE BOOM		
Arm length	2,0 m	2,65 m	3,2 m	3,5 m	2,65 m	3,2 m	3,5 m
M Transport length	10.080 mm	10.240 mm	10.185 mm	10.195 mm	10.060 mm	10.030 mm	9.970 mm
N Length on ground (transport)	6.615 mm	6.425 mm	5.625 mm	5.350 mm	6.825 mm	6.155 mm	5.765 mm
O Overall height (to top of boom)	3.160 mm	3.425 mm	3.340 mm	3.375 mm	3.180 mm	3.210 mm	3.230 mm
P Overall height (to top of hose)	-	-	-	-	3.565 mm	3.620 mm	3.730 mm

**PC290LC-8 / MAX. BUCKET CAPACITY AND WEIGHT**

MONO BOOM								
Arm length	2,0 m		2,65 m		3,2 m		3,5 m	
Material weight up to 1,2 t/m ³	2,02 m ³	1.400 kg	2,02 m ³	1.400 kg	2,02 m ³	1.400 kg	2,02 m ³	1.400 kg
Material weight up to 1,5 t/m ³	2,02 m ³	1.400 kg	1,98 m ³	1.375 kg	1,78 m ³	1.300 kg	1,72 m ³	1.275 kg
Material weight up to 1,8 t/m ³	1,93 m ³	1.350 kg	1,71 m ³	1.275 kg	1,50 m ³	1.200 kg	1,49 m ³	1.175 kg

TWO-PIECE BOOM								
Arm length	2,5 m		3,0 m		3,5 m			
Material weight up to 1,2 t/m ³	2,02 m ³	1.400 kg	2,02 m ³	1.400 kg	1,99 m ³	1.400 kg		
Material weight up to 1,5 t/m ³	1,95 m ³	1.375 kg	1,75 m ³	1.275 kg	1,68 m ³	1.250 kg		
Material weight up to 1,8 t/m ³	1,69 m ³	1.250 kg	1,52 m ³	1.175 kg	1,46 m ³	1.150 kg		

PC290NLC-8 / MAX. BUCKET CAPACITY AND WEIGHT

MONO BOOM								
Arm length	2,0 m		2,65 m		3,2 m		3,5 m	
Material weight up to 1,2 t/m ³	2,02 m ³	1.400 kg	2,02 m ³	1.400 kg	1,88 m ³	1.350 kg	1,82 m ³	1.300 kg
Material weight up to 1,5 t/m ³	2,00 m ³	1.400 kg	1,77 m ³	1.300 kg	1,59 m ³	1.200 kg	1,54 m ³	1.200 kg
Material weight up to 1,8 t/m ³	1,73 m ³	1.275 kg	1,53 m ³	1.175 kg	1,30 m ³	1.125 kg	1,33 m ³	1.100 kg

TWO-PIECE BOOM								
Arm length	2,5 m		3,0 m		3,5 m			
Material weight up to 1,2 t/m ³	2,02 m ³	1.400 kg	1,85 m ³	1.325 kg	1,78 m ³	1.300 kg		
Material weight up to 1,5 t/m ³	1,74 m ³	1.275 kg	1,56 m ³	1.200 kg	1,50 m ³	1.175 kg		
Material weight up to 1,8 t/m ³	1,51 m ³	1.175 kg	1,35 m ³	1.100 kg	1,30 m ³	1.075 kg		

Max. capacity and weight have been calculated according to ISO 10567:2007.
Please consult with your distributor for the correct selection of buckets and attachments to suit the application.

BUCKET AND ARM FORCE

Arm length	2,0 m	2,65 m	3,2 m	3,5 m
Bucket digging force	21.600 kg	21.600 kg	18.800 kg	18.800 kg
Bucket digging force at PowerMax	23.100 kg	23.100 kg	20.200 kg	20.200 kg
Arm crowd force	17.600 kg	15.280 kg	13.420 kg	12.000 kg
Arm crowd force at PowerMax	18.800 kg	16.320 kg	14.370 kg	12.800 kg

Working Range

MONO BOOM

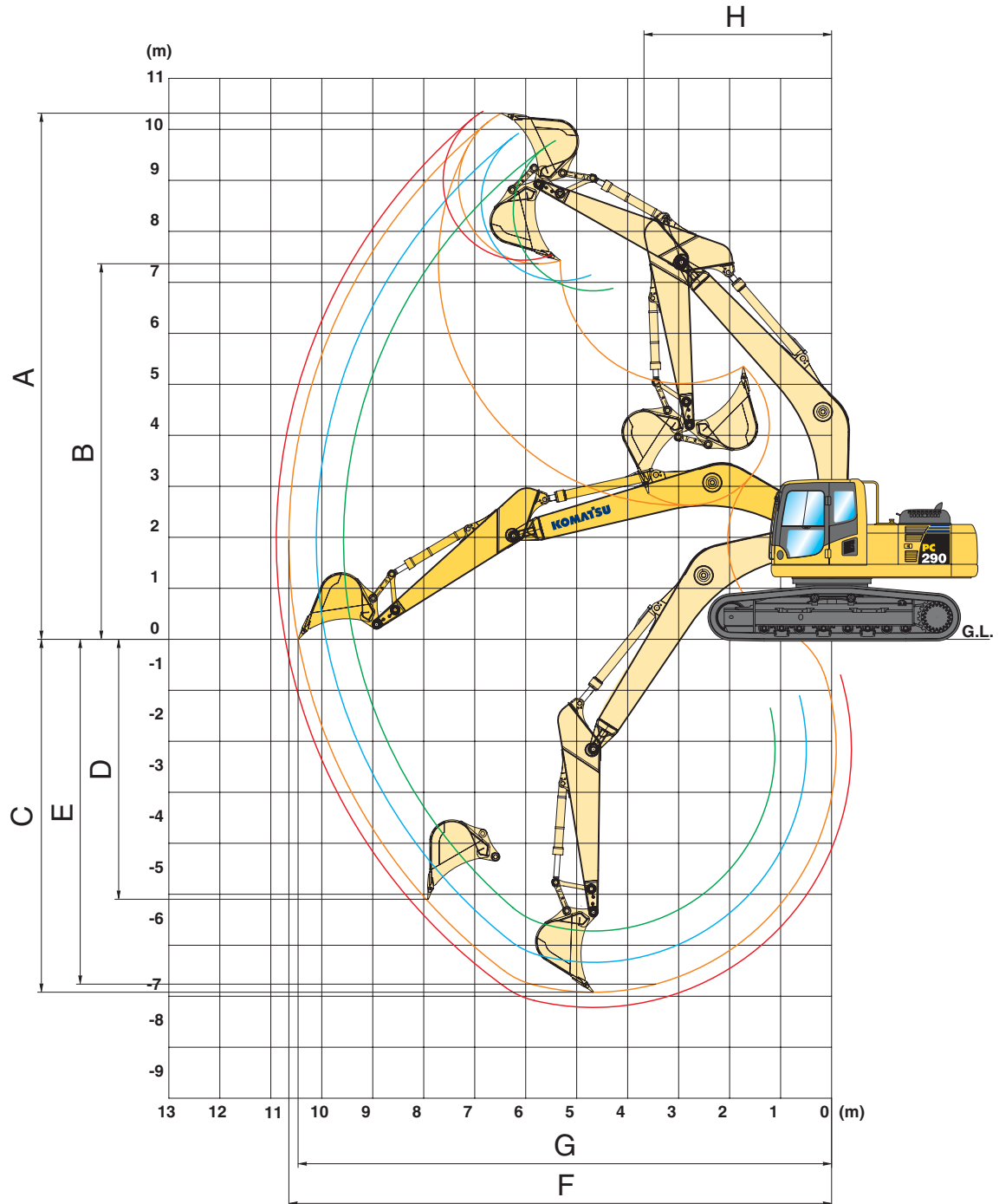

ARM LENGTH	2,0 m	2,65 m	3,2 m	3,5 m
A Max. digging height	9.780 mm	9.920 mm	10.315 mm	10.355 mm
B Max. dumping height	6.830 mm	7.030 mm	7.365 mm	7.435 mm
C Max. digging depth	5.720 mm	6.330 mm	6.920 mm	7.220 mm
D Max. vertical wall digging depth	3.910 mm	4.100 mm	5.100 mm	5.110 mm
E Max. digging depth of cut for 2,44 m level	5.500 mm	6.150 mm	6.760 mm	7.070 mm
F Max. digging reach	9.570 mm	10.110 mm	10.645 mm	10.890 mm
G Max. digging reach at ground level	9.370 mm	9.915 mm	10.465 mm	10.715 mm
H Min. swing radius	3.620 mm	3.570 mm	3.680 mm	3.740 mm



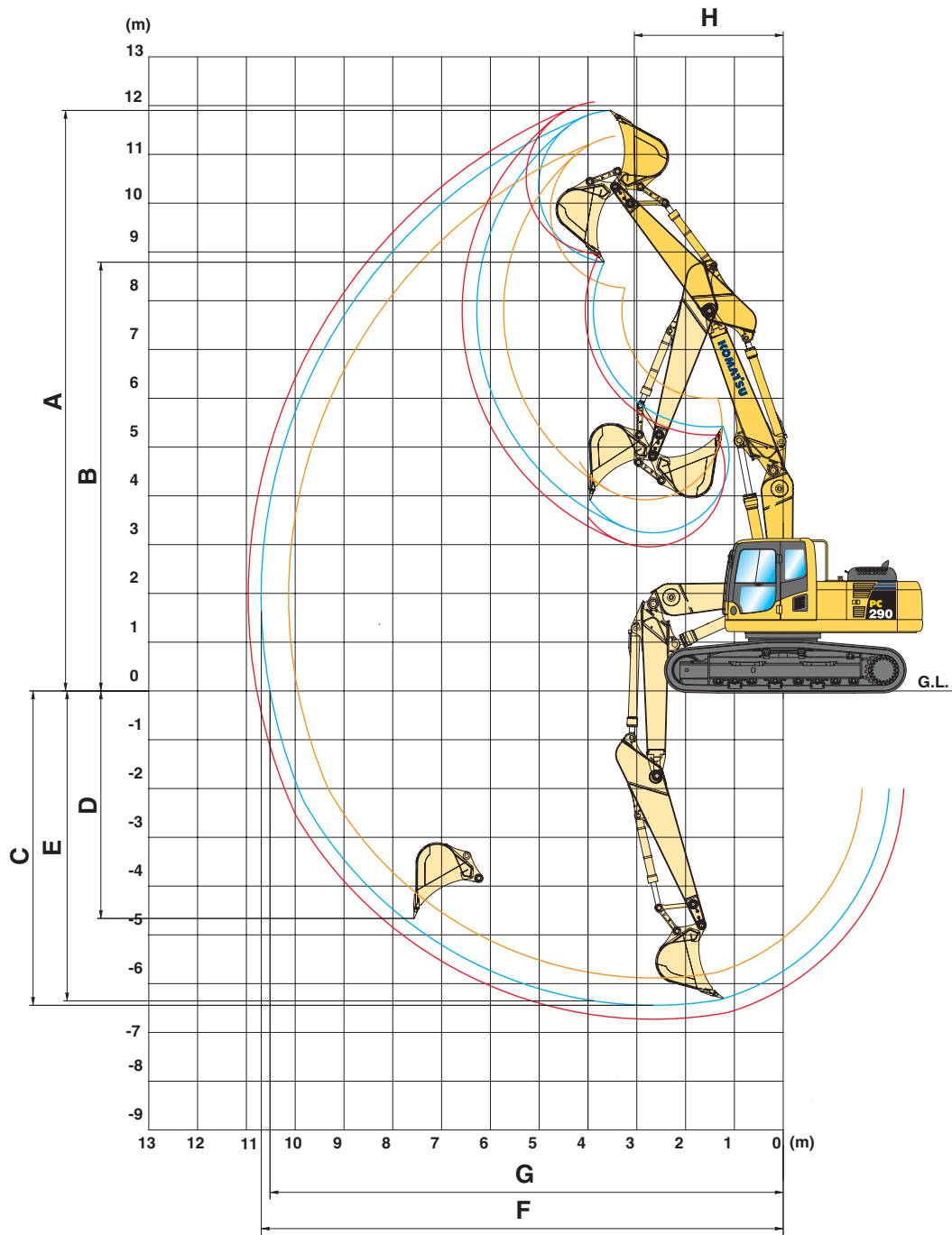















TWO-PIECE BOOM

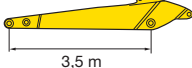

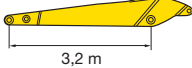
ARM LENGTH	2,65 m	3,2 m	3,5 m
A Max. digging height	11.375 mm	11.900 mm	12.100 mm
B Max. dumping height	8.265 mm	8.790 mm	8.980 mm
C Max. digging depth	5.880 mm	6.445 mm	6.735 mm
D Max. vertical wall digging depth	3.985 mm	4.665 mm	4.835 mm
E Max. digging depth of cut for 2,44 m level	5.785 mm	6.355 mm	6.650 mm
F Max. digging reach	10.130 mm	10.695 mm	10.970 mm
G Max. digging reach at ground level	9.940 mm	10.515 mm	10.800 mm
H Min. swing radius	3.210 mm	3.050 mm	3.090 mm

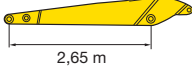
Lifting Capacity

PC290LC-8 MONO BOOM

Arm length	A		9,0 m		7,5 m		6,0 m		4,5 m		3,0 m			
	B													
 3,5 m  848 kg	6,0 m	kg	*3.030	*3.030		*5.320	4.990							
	4,5 m	kg	*3.080	*3.080	*3.520	*3.250	*6.180	4.840	*6.780	*6.780				
	3,0 m	kg	*3.260	3.100	*4.750	3.330	*6.880	4.610	*8.110	6.670	*10.530	*10.530	*16.980	*16.980
	1,5 m	kg	*3.570	2.980	5.480	3.210	7.390	4.380	*9.440	6.220	*13.050	9.660	*7.330	*7.330
	0,0 m	kg	*4.090	3.010	*5.370	3.120	7.180	4.190	10.240	5.890	*14.550	9.100	*8.680	*8.680
	-1,5 m	kg	*4.950	3.230			7.060	4.080	10.040	5.710	*14.960	8.880	*12.180	*12.180
	-3,0 m	kg	6.440	3.730			7.050	4.080	10.000	5.690	*14.410	8.900	*16.980	*16.980
-4,5 m	kg	*7.910	4.850					*9.420	5.820	*12.760	9.100	*18.040	*18.040	
 3,2 m  848 kg	6,0 m	kg	*3.320	*3.320		*5.490	4.930							
	4,5 m	kg	*3.370	*3.370		*6.420	4.790	*7.100	7.040					
	3,0 m	kg	*3.560	3.220	*4.260	3.300	*7.090	4.580	*8.410	6.600	*11.070	10.430	*12.910	*12.910
	1,5 m	kg	*3.900	3.100	*5.040	3.200	7.360	4.360	*9.690	6.190	*13.460	9.560		
	0,0 m	kg	*4.480	3.140			7.160	4.190	10.210	5.880	*14.760	9.080	*8.070	*8.070
	-1,5 m	kg	*5.450	3.390			7.060	4.100	10.040	5.730	*14.970	8.920	*12.280	*12.280
	-3,0 m	kg	6.790	3.950			7.090	4.120	10.040	5.730	*14.240	8.970	*17.750	*17.750
-4,5 m	kg	*8.040	5.250					*9.050	5.900	*12.330	9.200	*17.200	*17.200	
 2,65 m  848 kg	6,0 m	kg	*5.320	4.760		*5.640	4.830	*6.860	*6.860					
	4,5 m	kg	*5.450	4.010		*6.940	4.720	*7.780	6.890	*9.500	*9.500			
	3,0 m	kg	*5.810	3.620		*7.520	4.520	*9.000	6.470	*12.120	10.080			
	1,5 m	kg	5.910	3.480		7.320	4.330	10.140	6.090	*14.190	9.320			
	0,0 m	kg	6.060	3.540		7.170	4.180	10.170	5.840	*15.000	8.980			
	-1,5 m	kg	6.630	3.870		7.110	4.140	10.060	5.740	*14.790	8.920	*13.710	*13.710	
	-3,0 m	kg	7.980	4.650					10.130	5.800	*13.640	9.050	*18.820	18.690
-4,5 m	kg	*8.660	6.660							*11.120	9.380	*15.030	*15.030	
 2,0 m  848 kg	6,0 m	kg	*5.850	5.480				*7.750	7.180					
	4,5 m	kg	*5.990	4.560		*7.630	4.760	*8.620	6.890	*10.830	*10.830			
	3,0 m	kg	*6.420	4.110		7.610	4.610	*9.760	6.510	*13.420	9.960			
	1,5 m	kg	6.620	3.960		7.440	4.450	10.550	6.190	*15.050	9.360			
	0,0 m	kg	6.840	4.070		7.330	4.360	10.340	6.010	*15.280	9.190			
	-1,5 m	kg	7.610	4.510					10.300	5.980	*14.620	9.230	*14.630	*14.630
	-3,0 m	kg	*8.990	5.590					*9.800	6.100	*13.030	9.420	*17.000	*17.000
-4,5 m	kg													

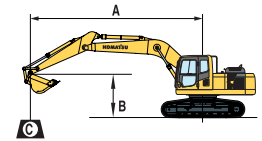

A – Reach from swing center

B – Bucket hook height

C – Lifting capacities, including bucket (848 kg), bucket linkage (200 kg) and bucket cylinder (140 kg)

 Rating over front

















 Rating over side

 Rating at maximum reach

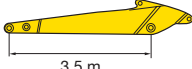
When removing bucket, linkage or cylinder, lifting capacities can be increased by their respective weights.

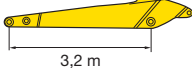
With 700 mm shoes

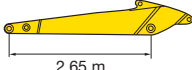
PC290LC-8 TWO-PIECE BOOM

Arm length	A		9,0 m		7,5 m		6,0 m		4,5 m		3,0 m			
	B													
 3,5 m  848 kg	6,0 m	kg	*2.760	*2.760		*5.230	4.920	*6.150	*6.150					
	4,5 m	kg	*2.740	*2.740	*3.520	3.380	*6.130	4.780	*7.110	7.030	*7.720	*7.720		
	3,0 m	kg	*2.820	*2.820	*4.850	3.300	7.060	4.570	*8.510	6.610	*11.360	10.520		
	1,5 m	kg	*3.010	2.910	5.490	3.210	6.850	4.360	*10.210	6.200	*12.180	9.640		
	0,0 m	kg	*3.340	2.970	5.420	3.140	7.200	4.190	10.280	5.900	*14.970	9.140	*7.280	*7.280
	-1,5 m	kg	*3.900	3.210			7.120	4.120	9.350	5.760	*13.350	8.970	*10.740	*10.740
	-3,0 m	kg							*9.490	5.770	*12.690	9.040		
 3,2 m  848 kg	6,0 m	kg	*3.030	*3.030		*5.460	4.860	*6.730	*6.730	*6.100	*6.100			
	4,5 m	kg	*2.990	*2.990		*6.560	4.730	*7.910	6.960	*9.000	*9.000	*9.120	*9.120	
	3,0 m	kg	*3.080	3.080	*4.410	3.280	7.030	4.540	*8.750	6.550	*11.790	10.380		
	1,5 m	kg	*3.290	3.040	*5.110	3.200	6.840	4.340	*10.400	6.160	*13.090	9.560		
	0,0 m	kg	*3.660	3.110	*4.310	3.150	7.200	4.200	10.270	5.900	*15.070	9.130	*6.660	*6.660
	-1,5 m	kg	*4.280	3.380			7.140	4.140	9.380	5.780	*13.220	9.010		
	-3,0 m	kg							*9.260	5.830				
 2,65 m  848 kg	6,0 m	kg	*4.940	4.560		*5.790	4.750	*8.210	7.120	*8.460	*8.460			
	4,5 m	kg	*4.920	3.880		7.090	4.660	*8.480	6.820	*11.160	10.970			
	3,0 m	kg	*5.100	3.540		6.970	4.490	*9.210	6.430	*12.620	10.050			
	1,5 m	kg	*5.500	3.430		6.800	4.320	10.470	6.080	*13.540	9.350			
	0,0 m	kg	6.020	3.520		7.210	4.210	10.230	5.870	*14.280	9.050			
	-1,5 m	kg	6.620	3.870		7.200	4.200	9.410	5.810	*12.740	9.040			
	-3,0 m	kg												

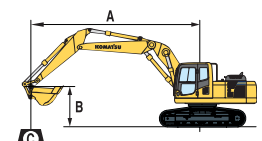

A – Reach from swing center

B – Bucket hook height

C – Lifting capacities, including bucket (848 kg), bucket linkage (200 kg) and bucket cylinder (140 kg)

 Rating over front

 Rating over side

 Rating at maximum reach

When removing bucket, linkage or cylinder, lifting capacities can be increased by their respective weights.

With 700 mm shoes

* Load is limited by hydraulic capacity rather than tipping. Ratings are based on SAE Standard No. J1097. Rated loads do not exceed 87% of hydraulic lift capacity or 75% of tipping load.

PC290NLC-8 MONO BOOM

Arm length	A		9,0 m		7,5 m		6,0 m		4,5 m		3,0 m			
	B													
 3,5 m 848 kg	6,0 m	kg	*3.030	*3.030	*5.320 4.490									
	4,5 m	kg	*3.080	3.010	*3.520	3.040	*6.180	4.340	*6.780	6.410				
	3,0 m	kg	*3.260	2.740	*4.750	2.950	*6.880	4.120	*8.110	5.970	*10.530	9.430	*16.980	*16.980
	1,5 m	kg	*3.570	2.620	5.380	2.830	7.250	3.880	*9.440	5.530	*13.050	8.540	*7.330	*7.330
	0,0 m	kg	*4.090	2.640	5.280	2.740	7.040	3.700	10.060	5.210	*14.550	8.000	*8.680	*8.680
	-1,5 m	kg	*4.950	2.830			6.920	3.590	9.850	5.040	*14.960	7.790	*12.180	*12.180
	-3,0 m	kg	6.320	3.280			6.920	3.590	9.820	5.010	*14.410	7.800	*16.980	15.680
-4,5 m	kg	*7.910	4.290					*9.420	5.140	*12.760	8.000	*18.040	16.130	
 3,2 m 848 kg	6,0 m	kg	*3.320	*3.320	*5.490 4.430									
	4,5 m	kg	*3.370	3.130	*6.420 4.290		*7.100	6.330						
	3,0 m	kg	*3.560	2.840	*4.260	2.920	*7.090	4.080	*8.410	5.910	*11.070	9.290	*12.910	*12.910
	1,5 m	kg	*3.900	2.720	*5.040	2.820	*7.220	3.870	*9.690	5.500	*13.460	8.450		
	0,0 m	kg	*4.480	2.760			7.030	3.700	10.030	5.200	*14.760	7.980	*8.070	*8.070
	-1,5 m	kg	*5.450	2.980			6.930	3.610	9.860	5.050	*14.970	7.820	*12.280	*12.280
	-3,0 m	kg	6.660	3.480			6.960	3.630	9.860	5.050	*14.240	7.870	*17.750	15.840
-4,5 m	kg	*8.040	4.650					*9.050	5.210	*12.330	8.100	*17.200	16.330	
 2,65 m 848 kg	6,0 m	kg	*5.320	4.260	*5.640 4.330		*6.860	6.510						
	4,5 m	kg	*5.450	3.570	*6.940 4.220		*7.780	6.190	*9.500	*9.500				
	3,0 m	kg	*5.810	3.210	7.400 4.030		*9.000	5.780	*12.120	8.950				
	1,5 m	kg	*5.800	3.070	7.190 3.830		*10.140	5.400	*14.190	8.210				
	0,0 m	kg	5.950	3.120	7.030 3.700		9.980	5.160	*15.000	7.890				
	-1,5 m	kg	6.510	3.410	6.980 3.650		9.880	5.070	*14.790	7.830	*13.710	*13.710		
	-3,0 m	kg	7.830	4.110					9.940	5.120	*13.640	7.950	*18.820	16.060
-4,5 m	kg	*8.660	5.900							*11.120	8.270	*15.030	*15.030	
 2,0 m 848 kg	6,0 m	kg	*5.850	4.920			*7.750	6.470						
	4,5 m	kg	*5.990	4.080	*7.630 4.260		*8.620	6.190	*10.830	9.740				
	3,0 m	kg	*6.420	3.670	7.480 4.110		*9.760	5.820	*13.420	8.840				
	1,5 m	kg	6.490	3.520	7.310 3.960		10.360	5.510	*15.050	8.260				
	0,0 m	kg	6.710	3.610	7.200 3.870		10.150	5.330	*15.280	8.090				
	-1,5 m	kg	7.470	4.010					10.110	5.300	*14.620	8.130	*14.630	*14.630
	-3,0 m	kg	*8.990	4.970					*9.800	5.420	*13.030	8.320	*17.000	*16.700
-4,5 m	kg													

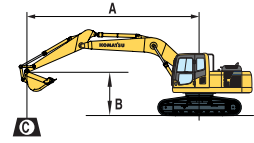

A – Reach from swing center

B – Bucket hook height

C – Lifting capacities, including bucket (848 kg), bucket linkage (200 kg) and bucket cylinder (140 kg)

– Rating over front

– Rating over side

– Rating at maximum reach

When removing bucket, linkage or cylinder, lifting capacities can be increased by their respective weights.

With 600 mm shoes

PC290NLC-8 TWO-PIECE BOOM

Arm length	A		9,0 m		7,5 m		6,0 m		4,5 m		3,0 m			
	B													
 3,5 m 848 kg	6,0 m	kg	*2.760	*2.760	*5.230 4.410		*6.150	*6.150						
	4,5 m	kg	*2.740	2.740	*3.520	2.990	*6.130	4.270	*7.110	6.320	*7.720	*7.720		
	3,0 m	kg	*2.820	2.640	*4.850	2.920	6.940	4.070	*8.510	5.910	*11.360	9.360		
	1,5 m	kg	*3.010	2.560	5.390	2.820	6.730	3.860	*10.210	5.510	*12.180	8.520		
	0,0 m	kg	*3.340	2.610	5.310	2.750	7.070	3.700	10.090	5.210	*14.970	8.030	*7.280	*7.280
	-1,5 m	kg	*3.900	2.820			6.980	3.620	9.190	5.080	*13.350	7.870	*10.740	*10.740
	-3,0 m	kg							9.950	5.090	*12.690	7.960		
 3,2 m 848 kg	6,0 m	kg	*3.030	*3.030	*5.460 4.350		*6.730	6.540	*6.100	*6.100				
	4,5 m	kg	*2.990	2.990	*6.560 4.230		*7.910	6.250	*9.000	*9.000	*9.120	*9.120		
	3,0 m	kg	*3.080	2.760	*4.410	2.900	6.910	4.040	*8.750	5.850	*11.790	9.230		
	1,5 m	kg	*3.290	2.670	*5.110	2.820	7.230	3.850	10.390	5.470	*13.090	8.440		
	0,0 m	kg	*3.660	2.730	*4.310	2.770	7.070	3.700	10.080	5.210	*15.070	8.020	*6.660	*6.660
	-1,5 m	kg	*4.280	2.970			7.010	3.650	9.210	5.100	*13.220	7.910		
	-3,0 m	kg							*9.260	5.140				
 2,65 m 848 kg	6,0 m	kg	*4.940	4.090	*5.790 4.250		*8.210	6.410	*8.460	*8.460				
	4,5 m	kg	*4.920	3.440	6.970 4.160		*8.480	6.110	*11.160	9.810				
	3,0 m	kg	*5.100	3.130	6.850 3.990		*9.210	5.730	*12.620	8.910				
	1,5 m	kg	5.730	3.020	6.680 3.830		10.290	5.390	*13.540	8.230				
	0,0 m	kg	5.910	3.100	7.080 3.720		10.040	5.180	*15.030	7.950				
	-1,5 m	kg	6.490	3.420	7.070 3.710		9.230	5.130	*12.740	7.940				
	-3,0 m	kg												

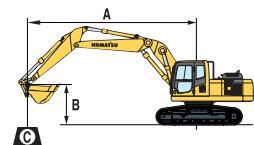

A – Reach from swing center

B – Bucket hook height

C – Lifting capacities, including bucket (848 kg), bucket linkage (200 kg) and bucket cylinder (140 kg)

– Rating over front

– Rating over side

– Rating at maximum reach

When removing bucket, linkage or cylinder, lifting capacities can be increased by their respective weights.

With 600 mm shoes

Hydraulic Excavator

PC290LC/NLC-8

Standard and Optional Equipment

ENGINE

Komatsu SAA6D107E-1 turbocharged common rail direct injection diesel engine	●
EU Stage IIIA/EPA Tier III compliant	●
Suction type cooling fan with radiator fly screen	●
Automatic engine warm-up system	●
Engine overheat prevention system	●
Fuel control dial	●
Auto-deceleration function	●
Engine key stop	●
Engine ignition can be password secured on request	●
Alternator 24 V/60 A	●
Starter motor 24 V/5,5 kW	●
Batteries 2 × 12 V/140 Ah	●
Diesel particulate filter	○

HYDRAULIC SYSTEM

Electronic closed-centre load sensing (E-CLSS) hydraulic system (HydrauMind)	●
Pump and engine mutual control (PEMC) system	●
One additional hydraulic circuit	●
5-working mode selection system; power mode, economy mode, breaker mode, attachment mode and lifting mode	●
PowerMax function	●
Adjustable PPC wrist control levers for arm, boom, bucket and swing, with sliding proportional control for attachments and 3 auxiliary buttons	●
Prepared for hydraulic quick-coupler	●
Additional hydraulic functions	○

UNDERCARRIAGE

Track roller guards	●
Track frame under-guards	●
LC and NLC undercarriages	○
600, 700, 800, 850 mm triple grouser track-shoes	○
Full length track roller guards	○

CABIN

Reinforced safety SpaceCab™; highly pressurised and tightly sealed hyper viscous mounted cab with tinted safety glass windows, large roof window with sun shade, pull-up type front window with locking device, removable lower window, front window wiper with intermittent feature, sun roller blind, cigarette lighter, ashtray, luggage shelf, floor mat	●
Heated air suspension seat with lumbar support, height adjustable arm rests and retractable seat belt	●
Automatic climate control system	●
12 Volt power supply	●
Beverage holder and magazine rack	●
Hot and cool box	●
Radio	●
Lower wiper	○
Rain visor (not with OPG)	○

SERVICE AND MAINTENANCE

Automatic fuel line de-aeration	●
Double element type air cleaner with dust indicator and auto dust evacuator	●
KOMTRAX™ - Komatsu satellite monitoring system	●
Multi-function video compatible colour monitor with Equipment Management and Monitoring System (EMMS) and efficiency guidance	●
Toolkit and spare parts for first service	●
Automatic greasing system	○
Service points	○

WORK EQUIPMENT

Mono boom	○
Two-piece boom	○
2,0 m; 2,65 m; 3,2 m; 3,5 m arms	○
Bucket linkage with lifting eye	○
Komatsu buckets	○
Komatsu breakers	○

SAFETY EQUIPMENT

Rear view camera system	●
Electric horn	●
Overload warning device	●
Lockable fuel cap and covers	●
Audible travel alarm	●
Boom safety valves	●
Large handrails, rear-view mirrors	●
Battery main switch	●
Arm safety valve	○
OPG Level II front guard (FOPS)	○
OPG Level II top guard (FOPS)	○

DRIVES AND BRAKES

Hydrostatic, 3-speed travel system with automatic shift and planetary gear type final drives, and hydraulic travel and parking brakes	●
PPC control levers and pedals for steering and travel	●

LIGHTING SYSTEM

Working lights: 2 revolving frame, 1 boom (l.h.)	●
Additional working lights: 4 cab roof (front), 1 cab roof (rear), 1 boom (r.h.), 1 counterweight (rear), beacon	○

OTHER EQUIPMENT

Standard counterweight	●
Remote greasing for swing circle and pins	●
Electric refuelling pump with automatic shut off function	●
Standard colour scheme and decals	●
Parts book and operator manual	●
Biodegradable oil for hydraulic system	○
Customised paint	○

Further equipment on request

- standard equipment
- optional equipment

Your Komatsu partner:

KOMATSU

Komatsu Europe International NV
 Mechelsesteenweg 586
 B-1800 VILVOORDE (BELGIUM)
 Tel. +32-2-255 24 11
 Fax +32-2-252 19 81
www.komatsu.eu

UESS11505 09/2010

Materials and specifications are subject to change without notice.
KOMATSU is a trademark of Komatsu Ltd. Japan.