



NEW HOLLAND LM

LM5.25 | LM6.28 | LM6.32 | LM6.35 Elite | LM7.35 | LM7.42 Elite | LM9.35



NEW HOLLAND EVOLUTION PUTS YOU AHEAD

Over the past 15 years, New Holland LM telehandlers have delivered an unrivalled mix of performance, dependability and affordability. With the latest LM series, enhanced performance and economy are matched to improved comfort and reduced operating costs.

The New Generation, five model range, consisting of the LM6.32, LM7.35, LM9.35 and LM6.35 Elite and LM7.42 Elite models, feature a new exceptionally strong boom and chassis, new engine and new transmissions. The very latest cab sets a benchmark for low noise and comfort. Purpose developed for those seeking a smaller handler, the compact, LM5.25 and LM6.28 have been updated with new engines, new styling and a revised cab.



MORE PRODUCTIVITY AND POWER

Standard LM handlers are rated at 110hp(CV) and deliver up to 121hp(CV). Elite models develop a rated 129hp(CV) and a maximum 143hp(CV). Previous LM models developed 120hp(CV) maximum. Compact LM models develop 75 and 101hp(CV). The latest LM series have enhanced productivity and economy. The New Generation LM range is the product of years of development, investment and listening to customer feedback.



SUPERIOR VISIBILITY AND COMFORT

New Holland has established its leadership in looking after the operator. The Standard and Elite LM range feature a new cab design that offers improved comfort, noise suppression and visibility over the previous generation. The compact range has new instruments and controls for enhanced ergonomics, with all LM models benefitting from enhanced air conditioning systems.





✓ **ENHANCED QUALITY**

Predecessor LM5000 telehandlers have a proven dependability record and high build quality, ensuring firm residual values. The all-new Standard and Elite telehandlers feature a newly designed, twin U shaped robot welded boom, that is extremely rigid and durable. The H shaped ladder chassis has massive torsional strength and is engineered to operate in the most demanding applications. New Holland has invested in a new dedicated LM production line between 2012 and 2013.

💰 **EASE OF OWNERSHIP**

Downtime is the enemy of productivity, but with a telehandler, downtime can also lead to livestock not getting fed, grain not being loaded and bales not getting cleared before the weather breaks. All LM telehandlers are engineered to minimise the need for routine maintenance for optimised dependability. Daily checks and routine care has been simplified, making it easier to look after the handler between its extended 600-hour service intervals.

SEVEN LM MODELS, COUNTLESS APPLICATIONS

At New Holland, we listen to our customers. We appreciate key telehandler demands vary between those seeking a handler with the reach to pick up, transport and stack large bales to those who need a compact machine that will see daily use for livestock duties - and everything in between. With the LM series, New Holland has a handler to suit specific demands. As a guide, each model number gives a broad indication of its maximum lift height and capacity. As an example, LM6.32 models will lift to 6.10m and offer a 3,200kg capacity, the LM7.35 operating up to 7.00m and offering 3,500kg capacity.



COMPACT BUT VERSATILE

The 75hp(CV) LM5.25 and 101hp(CV) LM6.28 measure just 1.80 and 2.00m wide respectively. With a turn radius of as low as 3.40m, these compact handlers can operate in tight spaces, a height of just 1.98m and 2.00m enabling either machine to work in low buildings to include pig and poultry units. But do not think compact dimensions means limited capacity. The LM5.25 and LM6.28 will lift 2,500 and 2,800kg to 5.78 and 6.35m respectively.

A SPECIFICATION TO SUIT YOUR NEEDS

New Holland offers its 'full-size' LM range in LM6.32, LM7.35 and LM9.35 models. Powered by Tier4A 4.5 litre NEF engines, with a maximum power output of 121hp(CV), these telehandlers have 4F-3R (four forward and three reverse speed) powershift transmissions with gears selectable on the joystick, while direction changes are handled by a column mounted powershuttle lever. A 120 litre/min hydraulic gear pump and manual three-mode steering system add to the high levels of equipment offered. A limited slip differential is standard for the front axle, while a limited slip differential lock is optional for the rear axle. Transport speed is an agile 40kph. Designed for applications to include materials handling, yard work and stacking large bales, these affordable telehandlers are the ideal choice for wide acre, arable, mixed farm and contract applications. A choice of rear trailer hitch types and hydraulic brake coupling, dependant upon market, are available.



Models		LM5.25	LM6.28	LM6.32	LM6.35 Elite	LM7.35	LM7.42 Elite	LM9.35
Max reach	(m)	5.78	6.35	6.10	6.10	7.00	7.00	9.10
Capacity	(kg)	2500	2800	3200	3500	3500	4200	3500



**ELITE POWER DELIVERS
OPTIMUM PERFORMANCE**

Two models are offered in the Elite range, the LM6.35 and LM7.42. These machines have a maximum power output of 143hp(CV) and have a 6F/3R (six forward and three reverse speed) powershift transmission. The forward and reverse powershuttle can be selected via the main joystick, the transmission offering automatic selection of speeds 4, 5 and 6. The three mode steering system features automatic alignment. Based around a variable displacement piston pump, the 140 litre/min hydraulic system is operated via an armrest mounted joystick. Offering precise proportional control with lightning

fast response, the hydraulic system makes Elite models the optimum choice for the most demanding operators. A high power to weight ratio enables these machines to carry out arduous duties to include heavy muck handling and silage clamp building. A limited slip differential is fitted to both front and rear axles as standard. With automated gearshifts, Elite telehandlers are also well suited to transport work. Towing capacity, with a braked trailer, is a massive 20 tons. Transport speed is up to 40kph. These combined features make Elite telehandlers the default choice for demanding farm and contract operators, their high power enabling them to deliver exceptional performance in the most demanding applications.

STRENGTH BY DESIGN

New Holland has made a huge investment in designing and testing that exceeds \$15 million US in the all-new LM Standard and Elite series. Further investment has been made in building a new LM production line, with new robot welders employed in both boom and chassis construction.

- Automatically ensuring the boom fully extends and returns to its fully drawn in position smoothly, hydraulic end-stroke dampers are incorporated into the boom rams, this hydraulic damping helps protect the boom and operator from shock loads.

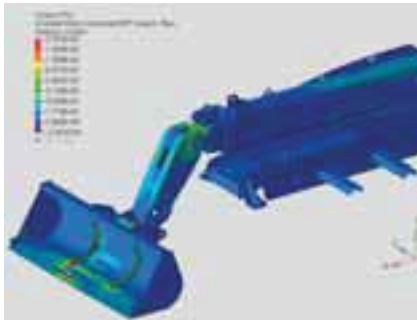

Based around twin U-shaped 10mm to 12mm thick sections, the completely new boom is immensely strong, with heavy duty pivot pins for optimum durability. New wear pads adjust quickly using a simple screw and lock nut design, without the need for special tools.



The boom hydraulic compensation cylinder is positioned to the rear of the boom and near the hinge point. The main lift ram is conventionally positioned under the boom. As the boom is raised both rams extend, but facing in opposite directions. This 'opposite working' helps to improve boom control, with additional benefits that include greater stability. The smooth action of the boom raise and lower reduces stress loads to enhance durability.



The one-piece H shape ladder chassis is made from 25mm thick, high tensile steel that is fully robot welded to ensure exceptional torsional rigidity. The boom support is exceptionally strong, its mass helping to counterbalance heavy loads.

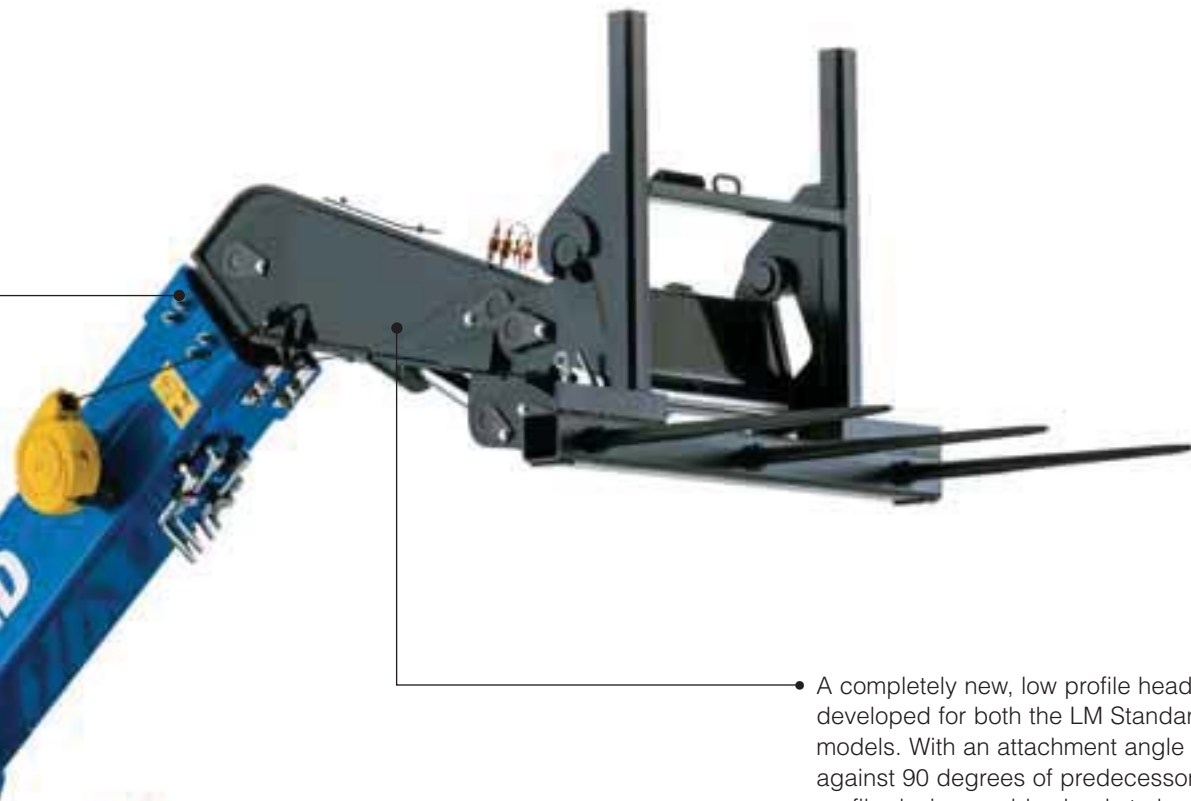

- A completely new, low profile headstock has been developed for both the LM Standard and LM Elite models. With an attachment angle of almost 45 degrees against 90 degrees of predecessor models, the lower profile design enables loads to be stacked closer to roofs. The carriage tilt angle for Standard models is 131 degrees, 142 degrees on LM Elite. A manual or hydraulic attachment lock can be specified.



- New Holland has engineered the chassis with 40/60 weight distribution to eliminate the need for a counterweight. The design delivers excellent stability and traction when loaded, the mass that would be used in a counterweight instead being built into the chassis to boost its strength.



Boom suspension can be specified. The system is activated by the operator and is designed to help reduce shock loads when working over difficult terrain. The system automatically deactivates when the boom exceeds a 35 degree lift angle.

SEE MORE FOR BETTER PRODUCTIVITY

New Holland has taken its established expertise in tractor cab design and applied it to the all-new 360 Vision Cab. Offering class-leading space and comfort, the cab affords excellent all-round visibility with an unparalleled view of the front of the carriage / forks when fully lowered. In work, this extra visibility boosts productivity in duties to include loader work and speeds up attachment changeovers.

MORE GLASS, BRILLIANT VISIBILITY

Extensive research by New Holland has led to the development of the 360 Vision Cab. A key aim was to help reduce 'blind spots' over the front of the boom, particularly when fully raised and fully lowered. By combining a wide and deep front screen with slim 'A' pillars, the visibility from the operators seat is greatly enhanced.

ENGINEERED FOR LOW NOISE

The best way to reduce noise is to eliminate its sources. By combining a number of design developments, LM Standard and LM Elite in-cab noise levels are just 75dB(A). A key to the low noise levels is the SCR equipped engines, these clean running power units also offering exceptionally low bystander noise levels.

OPERATOR COMFORT IS OUR PRIORITY

Regardless of LM model selected, all models offer a high level of operator comfort. From the way in which the controls are arranged and easy access to the cab, everything is focused on the operator.





LM STANDARD CAB AND CONTROLS

In the cab of LM Standard handlers, the electro hydraulic joystick is console mounted, with the forward reverse shuttle on the steering column. Neutral and transmission shift buttons are placed on the joystick. The steering wheel has tilt adjustment. A pneumatic suspended seat is an option.



LM ELITE CAB AND CONTROLS

The electronic joystick of LM Elite models is mounted on the seat armrest and includes the powershift, neutral and shuttle buttons. The steering wheel adjusts both for tilt and reach. A pneumatic suspended seat is an option.

SIX VENTS FOR COMFORT

Offered with a powerful air-conditioning system, the cab on both LM Standard and LM Elite handlers benefits from six ventilators. These are positioned to help not just keep the operator cool in hot weather, but to provide warm air when it is cold to prevent the cab from misting. The cab also features an opening rear window.



CLEAN PERFORMANCE. RESPONSIVE PRODUCTIVITY

LM Standard and LM Elite telehandlers are powered by Tier 4A NEF 4.5 litre, four-cylinder engines. Proven in the New Holland T6 tractor models, these exceptionally clean running engines have a long 600 hour service interval and a proven economy and dependability record. Rated power outputs are 110hp(CV) for the LM standard and 129hp(CV) for the LM Elite. These figures climb to 121hp(CV) and 143hp(CV) as engine speed drops to 1,800rpm (1,900rpm for Elite). Maximum output for the predecessor LM5000 models was 120hp(CV). To minimise power loss, the engine flywheel connects directly to the transmission via a heavy-duty 280mm torque convertor, a transfer box directing power to the front and rear axles. LM Standard and LM Elite models achieve a maximum 40kph transport speed and on both ranges transport mode is automatically engaged in 3rd gear or at speeds exceeding 12kph. This locks the rear steering wheels in the straight-ahead position, allowing steering from the front axle only.



Sustainable Efficient Technology

Models		LM6.32, LM7.35, LM9.35	LM6.35 Elite, LM7.42 Elite
Rated Power @ 2,200 rpm	[kW/hp(CV)]	81/110	96/129
Max Power @ 1,800 (1,900rpm for Elite)	[kW/hp(CV)]	89/121	105/143
Fuel tank capacity	(l)	140	140
AdBlue tank capacity	(l)	27	27
Powershift speeds (F/R)		4/3	6/3



UP TO 10% FUEL SAVINGS

When compared to the predecessor LM5000 handler range, the latest Tier 4A compliant power units are not only quieter and more powerful, but they are also up to 10% more economical too.

REVERSING FANS KEEP EVERYTHING COOL

Every 6 minutes, the engine and cooling package fan reverses direction for 15 seconds. This helps blow dust and contaminants from the engine radiator, oil cooler and intercooler and also helps keep the external engine hood screens free of debris. Working to the same cycle, two separate electrical fans reverse to clean the air conditioning, fuel cooler and transmission radiators.

FULL TIME 4WD AND AUTO TRACTION CONTROL

As standard, LM Standard and LM Elite telehandlers have full-time 4WD (four-wheel drive). A front limited slip differential is standard. Purpose developed for telehandler applications, the differential directs up to 45% of available torque across the axle to ensure the wheel with the greatest traction always get power. A locking rear differential is an option and comes as standard on Elite models.

HYDRAULIC WET DISK BRAKES

Designed to offer long life with minimal maintenance, the sealed wet disc brakes in both of the LM axles are designed to operate at higher transport speeds. When towing, the standard hydraulic trailer braking circuit is connected to the handlers' brakes to enhance safety. The parking brake* is activated via a dash mounted switch.

*SAHR system (Spring Applied hydraulic Release).

MANOEUVRABILITY AND STEERING MODES

When all-wheel steering is engaged, LM Standard and Elite telehandlers will turn in a radius of just 3.9m. In transport, front wheel steering is automatically selected, LM Elite models also feature auto wheel alignment when switching between, all-wheel, crab and front steering.

BIGGER TYRES

As standard, LM Standard and LM Elite telehandlers are fitted with 460/70R24 tyres. These are the ideal size for general purpose applications and yard work. Wider 500/70R24 can be specified. Ground clearance at the lowest point under the axles is 415mm, ample for duties to include building a silage clamp and working over difficult terrain.



LM STANDARD TRANSMISSION KEEPS IT SIMPLE

A full powershift 4F/3R (four-forward and three-reverse speed) transmission is fitted to LM Standard models, with clutch free changes between each gear. The operator chooses the speeds using buttons on the console-mounted joystick. Direction changes are made via a forward reverse shuttle lever on the steering column.

LM ELITE OFFERS AUTO FEATURES

LM Elite models feature a powershift 6F/3R (six-forward and three-reverse speed) transmission with the ability to select Auto mode. Effective in speeds 4, 5 and 6, Auto mode will select the most appropriate gear in relation to engine and forward speed and is well suited to transport duties. Towing capacity is 20 tonnes with a braked trailer.

POWERFUL HYDRAULICS DELIVER FAST WORK CYCLES

Efficient hydraulics are key to telehandler productivity. This goes beyond pump capacity; efficient use of available oil, optimised ram sizes and effective control valves all making a contribution to overall performance. The all-new LM Standard and LM Elite models benefit from New Holland's 15 years of telehandler development, careful attention to the design of the hydraulic circuit not just improving cycle times but also in ensuring performance is maintained in demanding conditions to include extreme heat. As an option, up to two rear remote valves can be specified. Additional valves and diverters to control front mounted attachments are also available.



Models		LM6.32	LM6.35 Elite	LM7.35	LM7.42 Elite	LM9.35
Hydraulic cycle times (unladen)						
Lift	(seconds)	7.4	6.7	7.4	6.7	7.4
Lower	(seconds)	5.6	5.2	5.6	5.2	5.6
Extend	(seconds)	5.5	5.2	6.5	6.2	8.3
Retract	(seconds)	3.7	3.7	4.4	4.5	6.3
Bucket Dump	(seconds)	3.1	2.8	3.1	2.8	3.1
Bucket Crowd	(seconds)	3.2	2.9	3.4	2.9	3.4



GEAR PUMP SIMPLICITY LINKED TO ADVANCED CONTROL

LM Standard telehandlers are fitted with 120l/min capacity gear pumps. To optimise performance, the console mounted joystick operates electro-hydraulic valves. Not only does this deliver full proportional control it also enables more than one function to be operated at a time for optimum productivity.

VARIABLE PUMP DELIVERS HIGH OUTPUT AT LOW ENGINE SPEEDS

LM Elite models are fitted with a high performance, variable displacement piston pump with a maximum output of 140l/min. Pump features include the ability to deliver a high rate of flow at all engine speeds but to also close down when there is no demand on the system. This allows more engine power to be diverted to the transmission and is of particular value in duties to include transport and when climbing a steep silage clamp. As soon as there is a demand for hydraulic flow, the pump delivers.

SMALL IN SIZE, BIG IN PERFORMANCE

With respective working widths of 1.80m and 2.00m, the 75hp(CV) and 101hp(CV) LM5.25 and LM6.28 have the compact dimensions to suit a wide range of applications. Size, however, should not be confused with a lack of performance, the diminutive LM5.25 lifting 2,500kg and stretching up to a full 5.78m. Fitted with new, cleaner engines, the compact LM models benefit from revised exterior styling that, as is typical of New Holland, is designed to not just make the machines look good, but help make them easier to clean and to further improve their excellent all-round visibility.



Engine power outputs	LM5.25	LM6.28
Max reach (m)	5.78	6.35
Capacity (kg)	2500	2800
Engine Rated Power [kW/hp(CV)]	55/75	74.5/101

CLEAN ENGINES WITH DPF

The 75hp(CV) LM5.25 complies with Tier 4 final emission regulations, the 101hp(CV) LM6.28 complies to Tier 4A. Both engines are fitted with a diesel particulate filter, DPF, that traps harmful soot generated during combustion. This will be of particular value to those operating the machines within a confined space.

HIGH PERFORMANCE HYDRAULICS

With respective outputs of 80l/min and 110l/min, the LM5.25 and LM6.28 can power up to four boom-mounted double acting auxiliary valves, with the option to also fit two at the rear.



SIMPLE CONTROLS

In the cab, the newly styled instrument cluster now includes tachometer, speedometer and fuel gauge dials. A central backlit LCD display lists key operating information that includes a DPF filter level indicator.



NEW JOYSTICK DESIGN

As standard, the 4 in 1 joystick offers two hydraulic and two electro proportional control buttons. This makes the operation of attachments simpler. As an option, the hydrostatic transmission can also be switched from forward, through neutral and into reverse via the joystick.



MORE POWERFUL AIR CONDITIONING

LM6.28 models are fitted with a more powerful air conditioning system, to ensure cool operation in hot weather.



HYDROSTATIC DRIVE SIMPLICITY

Compact telescopic handlers are ideally suited to re-handling materials and for duties that include numerous direction changes. LM5.25 features a single-speed hydrostatic transmission, the LM6.28 a dual-range transmission with an inching pedal. In operation, the drive pedal can be used to speed or slow the machine, with a much reduced need to operate the brakes.

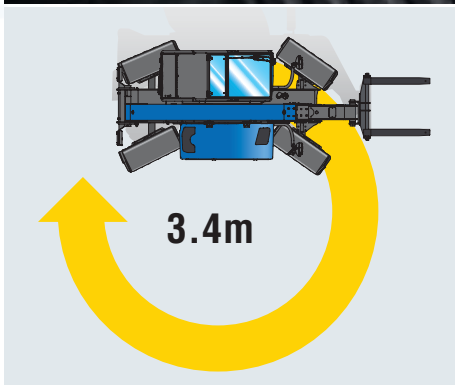

TOP MANOEUVRABILITY

Among the most compact in its class, the LM5.25 is the ideal choice for operating in low buildings with narrow access. To further boost its appeal, two wheel, four wheel and crab steer modes can be selected that can deliver a turn radius of just 3.40m. The wider LM6.28 turns in just 4.00m.



EASY TO LOOK AFTER. BUILT TO LAST

Manufactured to exacting quality standards, New Holland compact telehandlers are really simple to look after. Daily checks can be completed within a few minutes and, when a service is required, access to filters and key components is simplified by thoughtful design.

SIMPLE CHECKS FOR TROUBLE FREE OPERATION

New Holland has worked hard to reduce the maintenance demands of its all-new LM Standard and LM Elite telehandlers.



The once time consuming job of adjusting the telescopic boom pads has also been simplified, a simple nut screw and lock nut system making adjustment quick and easy.



Access to the 140 litre fuel tank is via a wide opening filler, allowing in-field refuelling with cans if ever necessary. With a capacity of 27 litres, the AdBlue tank is large enough to last for at least 5 fuel tank fills.



On Standard models, there are just nine daily grease points, Elite models having three extra on the high tip angle carriage. Every grease point is designed to be easy to access with remote greasing for those that would otherwise be difficult to reach.

- The engine hood lifts on gas struts for full access to the compact cooling package. Mounted on a frame that enables the radiators to both swing out and tilt for easy cleaning, an operator can easily carry out routine care in minutes.





FINANCE TAILORED TO YOUR BUSINESS

CNH Industrial Capital, the financial services company of New Holland, is well established and respected within the agricultural sector. Advice and finance packages tailored to your specific needs are available. With CNH Industrial Capital, you have the peace of mind that comes from dealing with a financing company that specialises in agriculture.

TRAINED TO GIVE YOU THE BEST SUPPORT

Your dedicated New Holland dealer technicians receive regular training updates. These are carried out both through on-line courses as well as intensive classroom sessions. This advanced approach ensures your dealer will always have the skills needed to look after the latest and most advanced New Holland products.

SERVICE PLUS – LONG LASTING CONFIDENCE

Service Plus coverage from Covéa Fleet provides owners of New Holland agricultural machinery with additional cover on the expiry of the manufacturer's contractual warranty. Please ask your dealer for more details. Terms and conditions apply.

NEW HOLLAND APPS

iBrochure

NH Weather

NH News

Farm Genius

PLM Calculator

PLM Academy

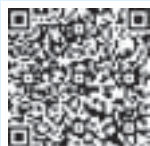

Experience New Holland
What's App!

Scan here to download the Apps



NEW HOLLAND STYLE

Want to make New Holland a part of your everyday life? Browse the comprehensive selection on www.newhollandstyle.com.

A whole range of items are available including hard wearing work clothing and a vast selection of scale models, together with so much more. New Holland. As individual as you.



MODELS		LM6.32	LM6.35 ELITE	LM7.35	LM7.42 ELITE	LM9.35
Max. lift capacity	(kg)	3200	3500	3500	4200	3500
Max. lift height (m)	(m)	6.1	6.1	7.0	7.0	9.1
Engine						
Type		4 cylinders - NEF Tier 4A / Stage 3B Common Rail				
ECOBlue™ SCR system (Selective Catalytic Reduction)		●	●	●	●	●
Aspiration		Turbo intercooler				
Displacement	(cm³)	4485				
Approved biodiesel blend		B20**				
Max. power ISO14396 - ECE R120 @ rpm	[kW/hp(CV)]	89/121 @ 1800	105/143 @ 1900	89/121 @ 1800	105/143 @ 1900	89/121 @ 1800
Rated power ISO14396 - ECE R120 @ rpm	[kW/hp(CV)]	81/110 @ 2200	96/129 @ 2200	81/110 @ 2200	96/129 @ 2200	81/110 @ 2200
Max. torque ISO14396 - ECE R120 @ rpm	(Nm)	498 @ 1500	590 @ 1500	498 @ 1500	590 @ 1500	498 @ 1500
Transmission						
Type		PowerShift™				
Speed		4x3	6x3 Auto-Shift	4x3	6x3 Auto-Shift	4x3
Transmission shifting		Incorporated on Joystick				
F-N-R integrated on joystick		-	●	-	●	-
F-N-R lever on steering wheel		●	-	●	-	●
Travel speed	(kph)	40				
Service brakes						
Actuation		Hydraulic power assisted				
All four wheels		Standard				
Type		Oil immersed discs				
Discs per axle		6 Front axle - 4 Rear axle				
Parking brake						
Actuation		Front axle SAHR (Spring Actuated Hydraulic Release)				
Type		Oil immersed discs				
Axles						
Limited slip differential front axle		●	●	●	●	●
Limited slip differential rear axle		○	●	○	●	○
Capacities						
Hydraulic oil tank	(Litres)	105				
Fuel tank / AdBlue tank	(Litres)	140 / 27				
Engine oil	(Litres)	12				
Hydraulic						
Gear pump	(lpm/bar)	120/240	-	120/240	-	120/240
Variable pump	(lpm/bar)	-	140/240	-	140/240	-
Boom controls						
Lift		Pilot	Electro Proportional	Pilot	Electro Proportional	Pilot
Tilt		Pilot	Electro Proportional	Pilot	Electro Proportional	Pilot
Extension		Electro Proportional	Electro Proportional	Electro Proportional	Electro Proportional	Electro Proportional
Headstock auxiliary		Electro Hydraulic	Electro Proportional	Electro Hydraulic	Electro Proportional	Electro Hydraulic
Hydraulic cycle times (unladen)						
Lift / Lower	(Seconds)	7.4 / 5.6	6.7 / 5.2	7.4 / 5.6	6.7 / 5.2	7.4 / 5.6
Extend / Retract	(Seconds)	5.5 / 3.7	5.2 / 3.7	6.5 / 4.4	6.2 / 4.5	8.3 / 6.3
Bucket dump / Bucket crowd	(Seconds)	3.1 / 3.2	2.8 / 2.9	3.1 / 3.4	2.8 / 2.9	3.1 / 3.4
Cab						
Max. noise level	[dB(A)]	75				
Vision	(°)	360				
Ventilation		Heater / Blower / Air Conditioning				
Tiltable steering column		●	●	●	●	●
Tiltable and telescopic steering column		-	●	-	●	-
Single lever joystick		Cab Mounted	Seat Mounted	Cab Mounted	Seat Mounted	Cab Mounted
Steering mode options		2WS / 4WS / Crab				
Steering mode selection						
Manual selection with front & rear pilot lights		●	-	●	-	●
Manual selection with automatic alignment		-	●	-	●	-
Wheels & tires						
Standard		460/70 R24				
Optional		500/70 R24				

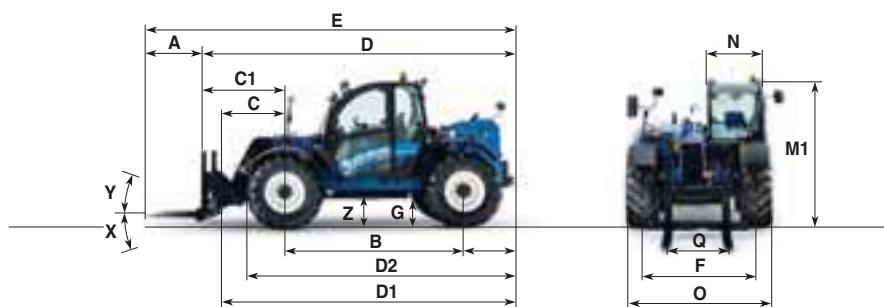

MODELS		LM6.32	LM6.35 ELITE	LM7.35	LM7.42 ELITE	LM9.35
Dimensions & weight						
A Pallet fork length	(mm)	1200	1200	1200	1200	1200
B Wheelbase	(mm)	3000	3000	3000	3000	3000
C Axle to carrier	(mm)	1031	1031	1285	1285	1513
C1 Axle to fork heel	(mm)	1158	1158	1410	1410	1645
D Length fork heel to counter weight	(mm)	4985	4985	5239	5239	5472
D1 Length carrier to counter weight	(mm)	4858	4858	5113	5113	5340
D2 Length front tyre to counter weight	(mm)	4450	4450	4450	4450	4450
E Overall length	(mm)	6190	6190	6451	6451	6672
F Wheel track	(mm)	1873	1873	1873	1873	1873
G Ground clearance	(mm)	415	415	415	415	415
Z Clearance under step	(mm)	550	550	550	550	550
N Cab width	(mm)	1020	1020	1020	1020	1020
Q Maximum fork spacing	(mm)	1185	1185	1185	1185	1185
Fork section	(mm)	100	100	100	100	100
M1 Cab height	(mm)	2447	2447	2447	2447	2447
O Overall width (outside tyres)	(mm)	2340	2340	2340	2340	2340
Y Attachment roll back angle	(°)	19	24	19	24	19
X Attachment dump angle	(°)	109	118	109	118	109
Total rotation angle (X+Y)	(°)	131	142	131	142	131
Turning radius tyres	(mm)	3900	3900	3900	3900	3900
Total weight with forks, full fuel tank and driver	(kg)	7935	7935	8000	8000	8580

MODELS

		LM5.25	LM6.28
Max. lift capacity	(kg)	2500	2800
Max. lift height	(m)	5.78	6.35
Boom suspension			
Smooth ride control - boom suspension		○	○
Engine			
Type		4 cylinder Tier 4A / Stage 3B Common Rail	4 cylinder Tier 4A / Stage 3B Common Rail
Displacement	(cm³)	3331	3769
Aspiration		Turbo compressor	Turbo compressor
Max. power ISO14396 - ECE R120 @ rpm	[kW/hp(CV)]	55.4/74.3 @ 2600	74.5/101 @ 2200
Max. torque ISO14396 - ECE R120 @ rpm	(Nm)	286 @ 1850	335 @ 1500
Cold climate start device		○	○
Transmission			
Variable capacity hydrostatic		Hydro single speed	Hydro 2 speed
Service brakes			
Actuation		Hydraulic power assisted	Hydraulic power assisted
All four wheels		Braking on two front wheels	Braking on two front wheels
Type		Oil immersed discs	Oil immersed discs
Discs per axle		6	6
Axles			
Differential lock	(Front / Rear)	● / ●	● / ●
Capacities			
Hydraulic oil	(Litres)	70	110
Fuel	(Litres)	80	100
Hydraulics			
Gear pump	(Lpm/bar)	80 / 230	110 / 230
Hydraulic controls		Proportional	Proportional
Joystick with proportional controls		●	●
Joystick with proportional, simultaneous, flow sharing controls, F-N-R integrated		○	○
Cab			
Max. noise level	[dB(A)]	80	80
Vision	(°)	360	360
Adjustable steering column		●	●
Power steering		2WS / 4WS / Crab	2WS / 4WS / Crab
Rotating beacon		●	●
Mechanical seat		●	●
Deluxe seat with pneumatic suspension		○	○
Heater		●	●
Air conditioning		○	○
Two cab pilot lights for steering alignment (LM6.28 only)		–	●
Sun visor (LM5.25 only)		○	–
Cab comfort kit - sun visor, oddments holder, phone holder, inclinometer		–	○
Reverse alarm		●	●
Lighting			
Front work lights on top of cab x 2		○	○
Rear work lights on top of cab x 2		○	○
Boom work lights		○	○
Wheels & tires			
Standard		12x18	405/70x20
Optional		12x16.5 Industrial	405/70x24

● Standard ○ Optional – Not Available

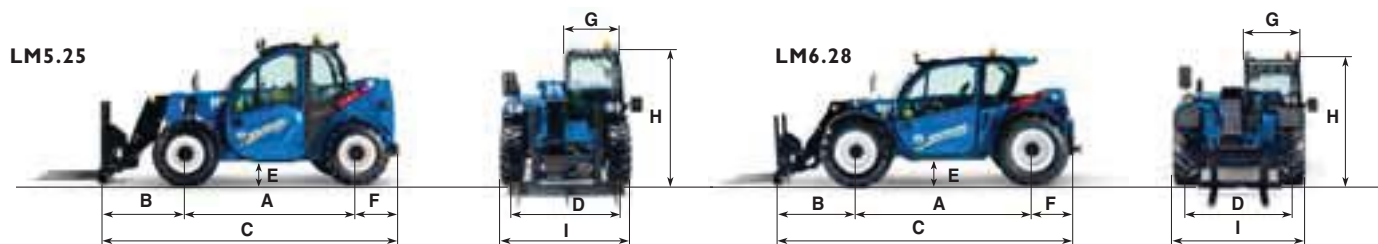

MODELS

		LM5.25	LM6.28
Dimensions & weight			
A Wheelbase	(mm)	2350	2800
B Axle to fork heel	(mm)	983	1200
C Length fork heel to counter weight	(mm)	4100	4670
D Wheel track	(mm)	1500	1600
E Ground clearance	(mm)	310	*350 / **390
F Length rear axle to counter weight	(mm)	763	650
G Cab width	(mm)	860	940
H Cab height	(mm)	1990	*2040 / **2080
I Overall width (outside tyres)	(mm)	1800	2000
Turning radius tyres	(mm)	3400	4000
Total weight with forks, full fuel tank and driver	(kg)	4800	6100

* 20" tyres ** 24" tyres

NEW HOLLAND TOP SERVICE: CUSTOMER SUPPORT AND CUSTOMER INFORMATION



TOP AVAILABILITY

If you need information, or have an out of hours question, ring our toll-free number*. All day, every day, we are just a call away.



TOP SPEED

Express parts delivery: when you need it, where you need it!



TOP PRIORITY

Fast-track solution during the season: because your harvest can't wait!



TOP SATISFACTION

We drive and track the solution you need, keeping you informed: until you are 100% satisfied!

TOP SERVICE

00800 64 111 111

* Calls to the Top Service team are free from landlines in the United Kingdom and Republic of Ireland. UK-based mobile calls are also free, but Republic of Ireland mobile users should call **01 2421881** and this will be charged at your standard network rate.

For more details, ask your New Holland dealer!

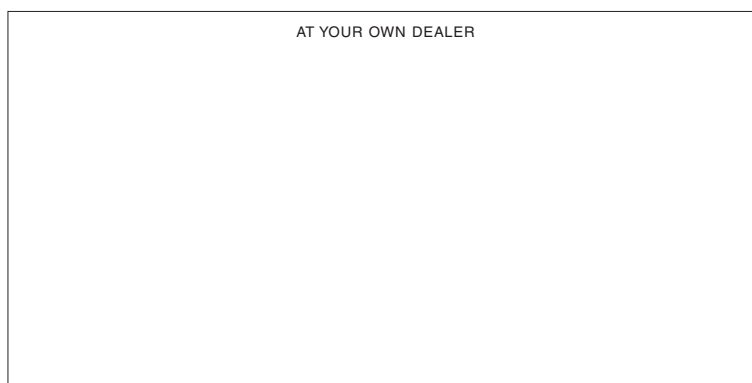

www.newholland.com/uk - www.newholland.com/ie

The data indicated in this folder are approximate. The models described here can be subjected to modifications without any notice by the manufacturer. The drawings and photos may refer to equipment that is either optional or intended for other countries. Please apply to our Sales Network for any further information. Published by New Holland Brand Communications. Bts Adv. - Printed in Italy - 09/14 - TP01 - (Turin) - 131000/INB

New Holland with

