

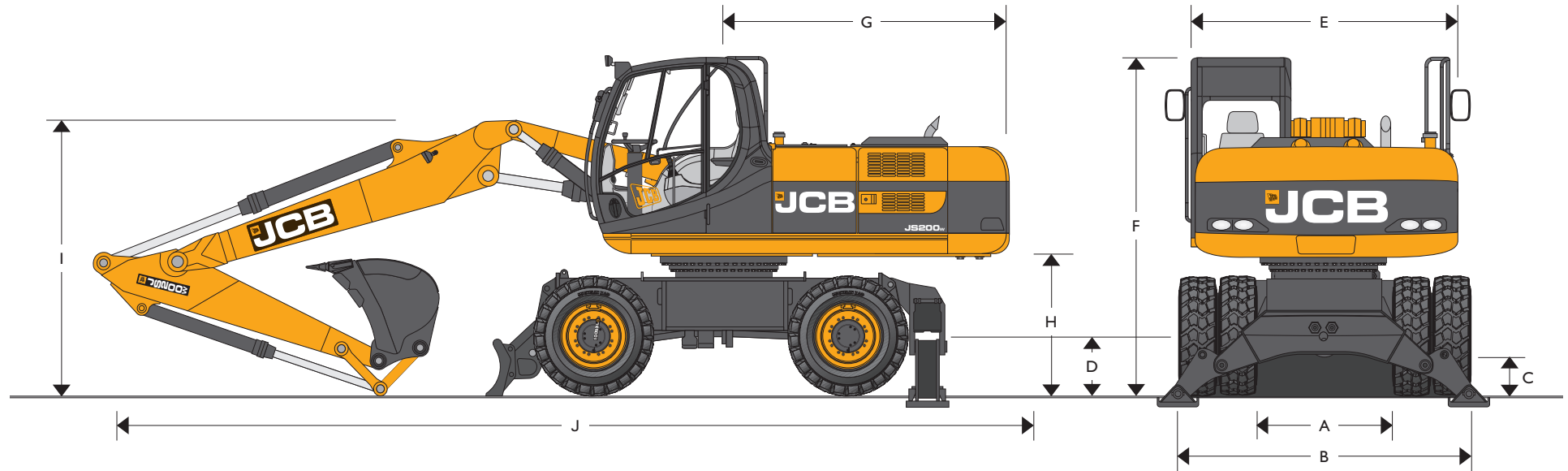

MAX. OPERATING WEIGHT: MONO 23202kg (51151lbs) / TAB 23273kg (51308lbs) ENGINE POWER: 128kW (172hp)



STATIC DIMENSIONS

Dimensions in millimetres (ft-in)		
A	Internal width between dual wheels	1330 (4-4)
B	External width over dual wheels	2530 (8-4)
C	Ground clearance	260 (0-10)
D	Height to axle centre line dual wheels	515 (1-8)
	Height to axle centre line single wheels	556 (1-9)
E	Overall width (handrail removed)	2500 (8-2)
F	Height over cab	3250 (10-8)
G	Tail length	2530 (8-3)
H	Clearance under counterweight	1335 (4-4)

Monoboom 5.70m (18-8)

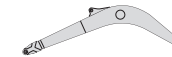

Dipper length		1.91m (6-3)	2.40m (7-10)	3.00m (9-10)	
I	Transport boom height	mm (ft-in)	3120 (10-2)	3200 (10-6)	3050 (10-0)
J	Transport length	mm (ft-in)	9450 (31-0)	9450 (31-0)	9330 (30-7)

Triple articulated boom 5.63m (18-6)



Dipper length		1.91m (6-3)	2.40m (7-10)	3.00m (9-10)	
I	Transport boom height	mm (ft-in)	3320 (10-10)	3400 (11-1)	3700 (12-1)
J	Transport length	mm (ft-in)	9175 (30-1)	9190 (30-1)	9200 (30-2)

CHASSIS OPTIONS

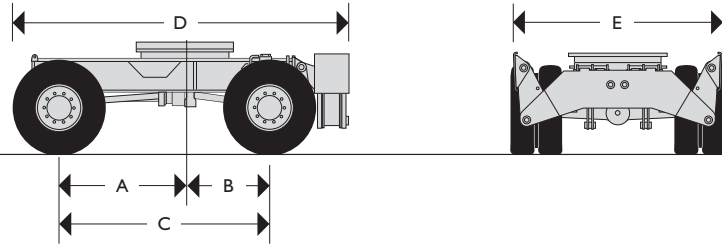

Dimensions in millimetres (ft-in)

A	Centre of slew ring to front axle	1507 (4-11)
B	Centre of slew ring to rear axle	1250 (4-1)
C	Wheelbase	2757 (9-0)
D	Length including rear stabilizers	4350 (14-3)
E	Width over stabilizers (raised)	2523 (8-3)

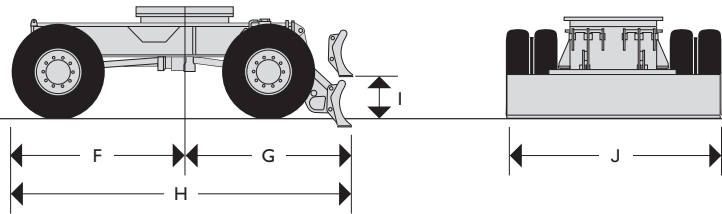

Dimensions in millimetres (ft-in)

F	Centre of slew ring to face of front tyre	2047 (6-8)
G	Centre of slew ring to rear dozer blade (lowered)	2425 (7-11)
H	Length including rear dozer blade (raised)	4470 (14-8)
I	Ground level to bottom of rear dozer blade (raised)	450 (1-4)
J	Dozer blade width	2530 (8-4)

CHASSIS OPTIONS

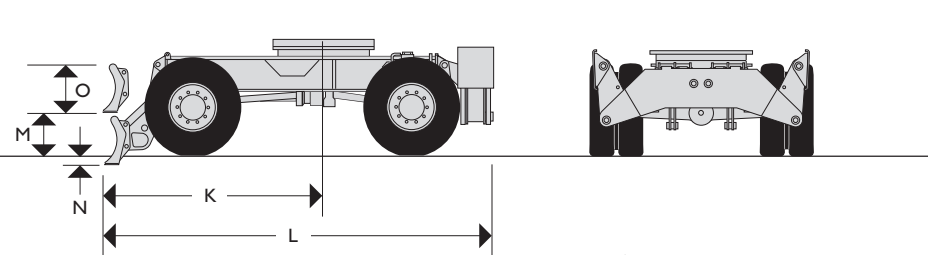

Dimensions in millimetres (ft-in)

K	Centre of slew ring to front dozer blade (lowered)	2760 (9-0)
L	Length including stabilizers and dozer blade (raised)	5060 (16-7)
M	Ground level to bottom of front dozer blade (raised)	450 (1-5)
N	Dozer blade dig depth	130 (0-5)
O	Dozer blade height	600 (1-11)

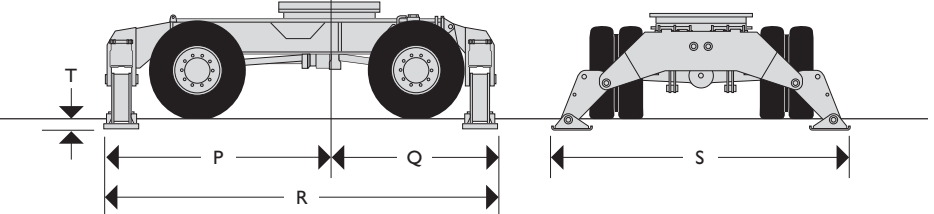

Dimensions in millimetres (ft-in)

P	Centre of slew ring to front stabilizers	2632 (8-7)
Q	Centre of slew ring to rear stabilizers	2300 (7-6)
R	Length including front and rear stabilizers	4932 (16-2)
S	Width over stabilizers (lowered)	3765 (12-4)
T	Stabilizer lift height	201 (0-7)



ENGINE

Type	Isuzu 4HK1X water cooled, 4-stroke, 4-cylinder in-line, direct injection, common rail turbocharged intercooled diesel. Stage III emissions compliant.
Rated power (ISO14899 (SAE J1995))	128kW (172hp) @ 2000rpm
Piston displacement	5.193 litres (1.14 UK gal).
Starting system	24 volt.
Batteries	2 x 12 volt Heavy Duty.
Alternator	24 volt 50 amp.

SWING SYSTEM

Drive train	Axial piston motor and planetary reduction final drive.
Swing brake	Hydraulic braking plus automatic spring applied disc type parking brake.
Swing speed	10RPM
Swing gear	Large diameter, internally toothed fully sealed grease bath lubricated.
Swing lock	Multi position switchable brake and mechanical lock.

CHASSIS

Structure	High strength section.
Chassis Options:	
Dozer Blade	Front and rear pin mount.
Stabilisers	Front or rear pin mount, independently operable – plus combinations.
Grab Stowage	Heavy-duty, pin mounted stowage bar.
Transmission	Hydrostatic drive via piston motor and powershift transmission.
Travel speed	Creep speed 3kph (2mph) Low ratio 8kph (5mph) High ratio 30kph (19mph)
Drawbar pull	99.4kN
Axles	Four wheel drive. Front steering axle oscillates for rough ground mobility.
Axle load capacity	40 tonnes
Axle oscillation	+/- 8.5 degrees
Ground clearance	335mm (1ft 1in)
Steering	Fully hydraulic system.
Turning radius	
To outside of tyres	6.61m (21ft 8in)
To outer edge of front mounted dozer blade	7.23m (23ft 9in)
Brakes	All hydraulic, dual circuit brake system.
Parking Brake	Built into the transmission.

EXCAVATOR END

Booms	Monoboom or triple articulation boom with choice of dipper lengths to match the requirements of reach, lift capacity and tearout.
Bucket tipping links	Fabricated type with choice of max capacity lift and no-lift point – with link stowage lock (grab work).



MAIN HYDRAULIC SYSTEM

System	Load-sensed hydraulic system with variable flow piston pump providing flow-on-demand for maximum efficiency.
Main pump	Variable displacement axial piston type
Maximum flow	2 x 214 l/min (93 UK gpm)
Main circuit pressure	343 bar (4879 lb/in ²)
With power boost	372 bar (5395 lb/in ²)
Servo pump	Gear type
Maximum flow	31 l/min (7 UK gpm)
Servo pressure	40 bar (580 lb/in ²)
Optional Circuits:	
Hammer	Includes automatic engine speed setting and return filter.
Maximum flow	200 l/min (44 UK gpm)
Maximum pressure	314 (343) bar (4554/4975 lb/in ²)
Hammer/auxiliary combined	(pre-set to 180 bar) (2610 lb/in ²)
Bucket to grab operation	
Maximum flow	138 l/min (30 UK gpm)
Maximum pressure for grab ram operation	330 (343) bar (4785/4975 lb/in ²)
Low Flow Pipework	Two options available, one with 20L/min (4 UK gpm) flow and a second with an adjustable flow of 27-45L/min (6-10 UK gpm).
Hydraulic Cylinders	With hardened, chromed piston rods and end cushioning on boom, dipper and bucket crowd cylinder.
Filtration	
In tank	150 micron, suction strainer.
Main return line	10 micron, fibreform element.
Pilot line	10 micron, paper element.
Plexus by pass line	1.5 micron paper element.
Hydraulic hammer return	10 micron, reinforced microform element.

TYRES

Twins	11.00 x 20 tyres (16PR) with spacer ring.
Singles	18R x 22.5 tyres (Radials).

CAB

Excellent digging, loading and positioning visibility results from the careful design of front, side and roof lights. All screens are tinted to improve in cab conditions.

Fully opening front screen is very smooth to operate and as the lower screen is stored within the top screen frame it makes complete front screen opening easy, fast and convenient.

Fresh air ventilation available from opening door window, opening slot in front screen and fully opening front screen.

Parallelogram wash wiper for upper screen ensuring good wiped area for maximum visibility. Wiper motor is fitted in the left hand side of the roof screen so as not to affect bucket visibility when loading. Optional lower screen wiper available.

Fresh air ventilation and heater with windscreen demister. Infinitely variable blower speed, temperature and recirculation control.

Climate control. Fully adjustable deluxe suspension seat with arm rest adjustment and backrest recline. Radio with digital tuner fitted into the roof lining for maximum protection. Conveniently placed radio mute button incorporated into lower console. 12v power point and mobile phone holder built into the right hand console. Courtesy light can be operated from ground level and is illuminated for five minutes or until switched off improving operator access at night. Cab mounted roller blind protects operator from suns' glare through front or top screens.

**AMS – ADVANCED MANAGEMENT SYSTEM**

Four selectable working modes link the operators control movements with the engine and hydraulic systems to maximise productivity and efficiency.

- A (Auto)** Up to 100% engine power and 100% flow. Gives variable power and speed depending on the operator's input, matching the demand for output and efficiency to the job. Power boost is automatically activated in this mode should hard conditions be encountered. Auto idle cuts in after a period of inactivity (between 5 and 30 seconds as set by the operator)
- E (Economy)** 80% engine power. 95% of hydraulic flow maximises economy while maintaining excellent output.
- P (Precision)** 55% engine power. 90% of hydraulic flow for fine control of grading operations.
- L (Lifting)** 55% engine power. 63% of hydraulic flow with permanent power boost for maximum lifting power and control.

The Auto mode allows the AMS processor to select the optimum operational performance to match the demands of the job while the three alternative modes give precise matching of application when specific tasks are undertaken.

The adjustable position monitor mounted on the front right hand pillar of the cab gives the operator a constant read out of mode, tracking range, operating temperature and a host of other information, while retaining excellent visibility of the monitor and the job being carried out.

The required flow for hammer applications can be set and stored in the AMS memory and is automatically activated whenever the hammer pedal is depressed.

A maintenance indicator warns of imminent service needs, and all servicing and basic checks can be carried out using only the in cab display.

STANDARD EXCAVATING BUCKETS

All buckets are JCB – Esco type fully welded steel, with sealed, hardened steel pivot pins and replaceable wear parts.

Max Width mm (in.)	Capacity (SAE heaped) cu.m (cu.yd)	Weight kg (lb)
600 (24)	0.40 (0.52)	484 (1067)
900 (36)	0.71 (0.93)	595 (1312)
1000 (40)	0.81 (1.06)	627 (1382)
1200 (48)	1.03 (1.35)	705 (1555)
1350 (53)	1.05 (1.37)	679 (1497)
1450 (57)	1.14 (1.49)	720 (1588)
1500 (59)	1.19 (1.56)	734 (1618)

SERVICE CAPACITIES

	litres	UK gal
Fuel tank	343	75
Engine coolant	33.3	7.32
Engine oil	24.5	5.4
Swing reduction gear	5.0	1
Hydraulic system	200	44
Hydraulic tank	226	49.7
Transmission	3.0	0.70
Axle hubs (each)	2.5	0.55







STANDARD EQUIPMENT

Engine fan guard; Cold start pre-heat; Auto engine warm up; Double element air cleaner; Heavy-duty alternator; Electrics isolator; Heavy duty batteries; Cab & engine soundproofing; Cab heater & screen demister; Tinted glass; Interior light; Coat hook; Cigarette lighter; Ashtray; Operator's storage box; Removable floor mat; Windscreen wash/wipe; Plug-in power socket; Automatic power boost; Auto-idle; One-touch engine speed control; Hydraulic cushion control; Plexus hydraulic oil filtration; HSP pressure test points; Auxiliary pipework mounting brackets; Work lights – boom & mainframe mounted; Upper structure under covers; Swing system cover; External mirrors; Handrail & non slip walk ways; Quick connect engine oil drain pipe; Front screen blind; Quick connect fuel tank drain pipe; Hinged engine under cover.

OPTIONAL EQUIPMENT

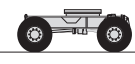
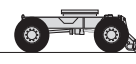
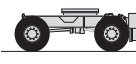
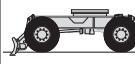
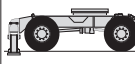
Hose burst check valves & overload warning system; Tipping link mounted lift points; General purpose buckets; Ditch/grading buckets; Quickhitch buckets; Hydraulic hammers; Auxiliary pipework (full and low flow); Climate control; Cab mounted & rear work lights; Rotating beacon; Rain guard; Biodegradeable oil; Air suspension seat with heated pad and lumbar support adjustment; Electric refuelling pump; Lower screen wiper; Radio; Cruise control; Grab stowage bar; FOPS (Level 2) operator protection; Biodegradeable oil; High and low temperature oils; Mesh front screen guard; Travel Alarm; Turbo II pre-cleaner.

OPERATING WEIGHTS

Chassis					
 MONO – 5T CWT	20475kg (45140lb)	21283kg (46921lb)	21380kg (47135lb)	22647kg (49928lb)	23202kg (51152lb)
 TAB – 4T CWT	20546kg (45296lb)	21354kg (47078lb)	21909kg (48301lb)	22718kg (50085lb)	23273kg (51308lb)
 TAB – 3.5T CWT (TUV COUNTRIES)	20046kg (44194lb)	20850kg (45966lb)	21409kg (47199lb)	22218kg (48982lb)	22773kg (50206lb)

Machine equipped with 2.4m (7-10) dipper excavating bucket and dual wheels. For single wheels subtract 400kg (880lb).

LIFT CAPACITIES – Dipper length: 1.9m, Monoboom 5.1m, No bucket, Front dozer, Rear stabilisers, 5 T Counterweight.
JS200W MONO

Reach	1.5m (4ft 11in)		3m (9ft 10in)		4.5m (14ft 9in)		6m (19ft 8in)		7.5m (24ft 7in)		Capacity at Max. Reach		
													mm
Load Point Ht.	kg	kg	kg	kg	kg	kg	kg	kg	kg	kg	kg	kg	mm
7.5m (24.6ft)											6860*	6860*	5308
6.0m (19.8ft)							6590*	6440			6450*	5540	6545
4.5m (14.9ft)					8820*	8820*	7120*	6240			6340*	4600	7262
3.0m (9.10ft)					10910*	9090	7980*	5960	6780*	4280	6550*	4180	7613
1.5m (4.11ft)					12140*	8670	8710*	5720	7040*	4180	6930*	4060	7650
0m					12220*	8570	9000*	5610			7160*	4230	7378
- 1.5m (- 4.11ft)			12270*	12270*	11530*	8630	8630*	5620			7380*	4800	6758
- 3.0m (- 9.10ft)			12920*	12920*	9790*	8830					7430*	6290	5672
- 4.5m (- 14.9ft)													

LIFT CAPACITIES – Dipper length: 2.4m, Monoboom 5.1m, No bucket, Front dozer, Rear stabilisers, 5 T Counterweight.
JS200W MONO

Reach	1.5m (4ft 11in)		3m (9ft 10in)		4.5m (14ft 9in)		6m (19ft 8in)		7.5m (24ft 7in)		Capacity at Max. Reach		
													mm
Load Point Ht.	kg	kg	kg	kg	kg	kg	kg	kg	kg	kg	kg	kg	mm
7.5m (24.6ft)											5300*	5300*	5940
6.0m (19.8ft)							6140*	6140*			4920*	4920*	7063
4.5m (14.9ft)					8170*	8170*	6770*	6400	6210*	4500	4850*	4410	7731
3.0m (9.10ft)					10310*	9370	7710*	6100	6560*	4380	4990*	4050	8061
1.5m (4.11ft)					11880*	8850	8560*	5840	6960*	4260	5350*	3950	8096
0m					12360*	8650	9020*	5680	7140*	4180	6040*	4080	7839
- 1.5m (- 4.11ft)			11640*	11640*	11970*	8650	8900*	5650			7050*	4530	7260
- 3.0m (- 9.10ft)			14560*	14560*	10630*	8800	7770*	5770			7230	5640	6266
- 4.5m (- 14.9ft)													

LIFT CAPACITIES – Dipper length: 3.0m, Monoboom 5.1m, No bucket, Front dozer, Rear stabilisers, 5 T Counterweight.
JS200W MONO

Reach	1.5m (4ft 11in)		3m (9ft 10in)		4.5m (14ft 9in)		6m (19ft 8in)		7.5m (24ft 7in)		Capacity at Max. Reach		
													mm
Load Point Ht.	kg	kg	kg	kg	kg	kg	kg	kg	kg	kg	kg	kg	mm
7.5m (24.6ft)											3400*	3400*	6653
6.0m (19.8ft)							5390*	5390*	3950*	3950*	3200*	3200*	7669
4.5m (14.9ft)							6100*	6100*	5620*	4480	3160*	3160*	8287
3.0m (9.10ft)					9300*	9300*	7100*	6100	6090*	4340	3260*	3260*	8594
1.5m (4.11ft)					11180*	8890	8090*	5800	6590*	4180	3490*	3390	8627
0m			6370*	6370*	12090*	8570	8740*	5590	6930*	4070	3900*	3480	8388
- 1.5m (- 4.11ft)	7170*	7170*	10860*	10860*	12090*	8490	8880*	5510	6880*	4040	4660*	3950	7850
- 3.0m (- 9.10ft)	11690*	11690*	16000*	16000*	11190*	8570	8270*	5560			6220*	4720	6944
- 4.5m (- 14.9ft)			12460*	12460*	8870*	8860					6850*	6820	5480



Lift capacity front and rear.



Lift capacity full circle.

Notes:

- For lifting capacity including bucket, subtract total weight of bucket or bucket and quickhitch from above values.
- Lifting capacities are based on ISO 10567, that is: 75% of minimum tipping load or 87% of hydraulic lift capacity, whichever is the less. Lifting capacities marked* are based on hydraulic capacity.
- Lift capacities assume that the machine is on firm, level ground.
- Lift capacities may be limited by local regulations. Please refer to your dealer.

LIFT CAPACITIES – Dipper length: 1.9m, Monoboom 5.1m, No bucket, Rear stabilisers, 5 T Counterweight.
JS200W MONO

Reach	1.5m (4ft 11in)		3m (9ft 10in)		4.5m (14ft 9in)		6m (19ft 8in)		7.5m (24ft 7in)		Capacity at Max. Reach			
Load Point Ht.	kg	kg	kg	kg	kg	kg	kg	kg	kg	kg	kg	kg	mm	
7.5m (24.6ft)												6860*	6100	5308
6.0m (19.8ft)							6590*	4970				6450*	4270	6545
4.5m (14.9ft)					8820*	7380	7120*	4780				6240	3520	7262
3.0m (9.10ft)					10910*	6720	7980*	4510	5810	3250		5670	3180	7613
1.5m (4.11ft)					12140*	6330	8040	4290	5710	3160		5540	3070	7650
0m					12220*	6240	7910	4180				5800	3190	7378
- 1.5m (- 4.11ft)			12270*	12270*	11530*	6290	7920	4190				6640	3610	6758
- 3.0m (- 9.10ft)			12920*	12690	9790*	6480						7430*	4720	5672
- 4.5m (- 14.9ft)														

LIFT CAPACITIES – Dipper length: 2.4m, Monoboom 5.1m, No bucket, Rear stabilisers, 5 T Counterweight.
JS200W MONO

Reach	1.5m (4ft 11in)		3m (9ft 10in)		4.5m (14ft 9in)		6m (19ft 8in)		7.5m (24ft 7in)		Capacity at Max. Reach			
Load Point Ht.	kg	kg	kg	kg	kg	kg	kg	kg	kg	kg	kg	kg	mm	
7.5m (24.6ft)												5300*	5220	5940
6.0m (19.8ft)							6140*	5140				4920*	3890	7063
4.5m (14.9ft)					8170*	7640	6770*	4930	6050	3470		4850*	3290	7731
3.0m (9.10ft)					10310*	6980	7710*	4650	5920	3360		4990*	3000	8061
1.5m (4.11ft)					11880*	6500	8170	4400	5790	3240		5160	2900	8096
0m					12360*	6320	7990	4260	5700	3160		5350	2990	7839
- 1.5m (- 4.11ft)			11640*	11640*	11970*	6320	7950	4220				5990	3310	7260
- 3.0m (- 9.10ft)			14560*	12560	10630*	6450	7770*	4340				7230*	4110	6266
- 4.5m (- 14.9ft)														

LIFT CAPACITIES – Dipper length: 3.0m, Monoboom 5.1m, No bucket, Rear stabilisers, 5 T Counterweight.
JS200W MONO

Reach	1.5m (4ft 11in)		3m (9ft 10in)		4.5m (14ft 9in)		6m (19ft 8in)		7.5m (24ft 7in)		Capacity at Max. Reach			
Load Point Ht.	kg	kg	kg	kg	kg	kg	kg	kg	kg	kg	kg	kg	mm	
7.5m (24.6ft)												3400*	3400*	6653
6.0m (19.8ft)							5390*	5170	3950*	3520		3200*	3200*	7669
4.5m (14.9ft)							6100*	4950	5620*	3450		3160*	2890	8287
3.0m (9.10ft)					9300*	7100	7100*	4650	5890	3310		3260*	2640	8594
1.5m (4.11ft)					11180*	6530	8090*	4360	5720	3160		3490*	2560	8627
0m			6370*	6370*	12090*	6230	7910	4170	5600	3060		3900*	2610	8388
- 1.5m (- 4.11ft)	7170*	7170*	10860*	10860*	12090*	6160	7810	4090	5560	3020		4660*	2850	7850
- 3.0m (- 9.10ft)	11690*	11690*	16000*	12200	11190*	6240	7860	4130				6220*	3420	6944
- 4.5m (- 14.9ft)			12460*	12460*	8870*	6490						6850*	4930	5480



Lift capacity front and rear.



Lift capacity full circle.

Notes:

- For lifting capacity including bucket, subtract total weight of bucket or bucket and quickhitch from above values.
- Lifting capacities are based on ISO 10567, that is: 75% of minimum tipping load or 87% of hydraulic lift capacity, whichever is the less. Lifting capacities marked* are based on hydraulic capacity.
- Lift capacities assume that the machine is on firm, level ground.
- Lift capacities may be limited by local regulations. Please refer to your dealer.

LIFT CAPACITIES – Dipper length: 1.9m, Monoboom 5.1m, No bucket, 4 stabilisers, 5 T Counterweight.
JS200W MONO

Reach	1.5m (4ft 11in)		3m (9ft 10in)		4.5m (14ft 9in)		6m (19ft 8in)		7.5m (24ft 7in)		Capacity at Max. Reach			
													mm	
Load Point Ht.	kg	kg	kg	kg	kg	kg	kg	kg	kg	kg	kg	kg	mm	
7.5m (24.6ft)												6860*	6860*	5308
6.0m (19.8ft)							6590*	6590*				6450*	6450*	6545
4.5m (14.9ft)					8820*	8820*	7120*	7120*				6340*	5690	7262
3.0m (9.10ft)					10910*	10910*	7980*	7460	6780*	5310		6550*	5190	7613
1.5m (4.11ft)					12140*	11260	8710*	7210	7040*	5210		6930*	5060	7650
0m					12220*	11140	9000*	7090				7160*	5290	7378
- 1.5m (- 4.11ft)			12270*	12270*	11530*	11200	8630*	7100				7380*	6010	6758
- 3.0m (- 9.10ft)			12920*	12920*	9790*	9790*						7430*	7430*	5672
- 4.5m (- 14.9ft)														

LIFT CAPACITIES – Dipper length: 2.4m, Monoboom 5.1m, No bucket, 4 stabilisers, 5 T Counterweight.
JS200W MONO

Reach	1.5m (4ft 11in)		3m (9ft 10in)		4.5m (14ft 9in)		6m (19ft 8in)		7.5m (24ft 7in)		Capacity at Max. Reach			
													mm	
Load Point Ht.	kg	kg	kg	kg	kg	kg	kg	kg	kg	kg	kg	kg	mm	
7.5m (24.6ft)												5300*	5300*	5940
6.0m (19.8ft)							6140*	6140*				4920*	4920*	7063
4.5m (14.9ft)					8170*	8170*	6770*	6770*	6210*	5540		4850*	4850*	7731
3.0m (9.10ft)					10310*	10310*	7710*	7610	6560*	5420		4990*	4850	8061
1.5m (4.11ft)					11880*	11450	8560*	7330	6960*	5290		5350*	4730	8096
0m					12360*	11230	9020*	7160	7140*	5210		6040*	4910	7839
- 1.5m (- 4.11ft)			11640*	11640*	11970*	11220	8900*	7130				7050*	5460	7260
- 3.0m (- 9.10ft)			14560*	14560*	10630*	10630*	7770*	7250				7230*	6830	6266
- 4.5m (- 14.9ft)														

LIFT CAPACITIES – Dipper length: 3.0m, Monoboom 5.1m, No bucket, 4 stabilisers, 5 T Counterweight.
JS200W MONO

Reach	1.5m (4ft 11in)		3m (9ft 10in)		4.5m (14ft 9in)		6m (19ft 8in)		7.5m (24ft 7in)		Capacity at Max. Reach			
													mm	
Load Point Ht.	kg	kg	kg	kg	kg	kg	kg	kg	kg	kg	kg	kg	mm	
7.5m (24.6ft)												3400*	3400*	6653
6.0m (19.8ft)							5390*	5390*	3950*	3950*		3200*	3200*	7669
4.5m (14.9ft)							6100*	6100*	5620*	5530*		3160*	3160*	8287
3.0m (9.10ft)					9300*	9300*	7100*	7100*	6090*	5380		3260*	3260*	8594
1.5m (4.11ft)					11180*	11180*	8090*	7300	6590*	5220		3490*	3490*	8627
0m			6370*	6370*	12090*	11150	8740*	7080	6930*	5100		3900*	3900*	8388
- 1.5m (- 4.11ft)	7170*	7170*	10860*	10860*	12090*	11060	8880*	6990	6880*	5070		4660*	4660*	7850
- 3.0m (- 9.10ft)	11690*	11690*	16000*	16000*	11190*	11150	8270*	7040				6220*	5730	6944
- 4.5m (- 14.9ft)			12460*	12460*	8870*	8870*						6850*	6850*	5480



Lift capacity front and rear.



Lift capacity full circle.

Notes:

- For lifting capacity including bucket, subtract total weight of bucket or bucket and quickhitch from above values.
- Lifting capacities are based on ISO 10567, that is: 75% of minimum tipping load or 87% of hydraulic lift capacity, whichever is the less. Lifting capacities marked* are based on hydraulic capacity.
- Lift capacities assume that the machine is on firm, level ground.
- Lift capacities may be limited by local regulations. Please refer to your dealer.

LIFT CAPACITIES – Dipper length: 1.9m, Monoboom 5.1m, No bucket, Rear dozer, 5 T Counterweight.
JS200W MONO

Reach	1.5m (4ft 11in)		3m (9ft 10in)		4.5m (14ft 9in)		6m (19ft 8in)		7.5m (24ft 7in)		Capacity at Max. Reach			
													mm	
Load Point Ht.	kg	kg	kg	kg	kg	kg	kg	kg	kg	kg	kg	kg	mm	
7.5m (24.6ft)												6860*	4880	5308
6.0m (19.8ft)							6590*	3970				6450*	3390	6545
4.5m (14.9ft)					8820*	5790	7120*	3790				6340*	2770	7262
3.0m (9.10ft)					10910*	5170	7980*	3530	6780*	2540		6550*	2480	7613
1.5m (4.11ft)					12140*	4810	8710*	3320	7040*	2450		6930*	2380	7650
0m					12220*	4720	9000*	3210				7160*	2470	7378
- 1.5m (- 4.11ft)			12270*	9080	11530*	4770	8630*	3220				7380*	2790	6758
- 3.0m (- 9.10ft)			12920*	9280	9790*	4950						7430*	3650	5672
- 4.5m (- 14.9ft)														

LIFT CAPACITIES – Dipper length: 2.4m, Monoboom 5.1m, No bucket, Rear dozer, 5 T Counterweight.
JS200W MONO

Reach	1.5m (4ft 11in)		3m (9ft 10in)		4.5m (14ft 9in)		6m (19ft 8in)		7.5m (24ft 7in)		Capacity at Max. Reach			
													mm	
Load Point Ht.	kg	kg	kg	kg	kg	kg	kg	kg	kg	kg	kg	kg	mm	
7.5m (24.6ft)												5300*	4210	5940
6.0m (19.8ft)							6140*	4140				4920*	3120	7063
4.5m (14.9ft)					8170*	6060	6770*	3940	6210*	2760		4850*	2610	7731
3.0m (9.10ft)					10310*	5430	7710*	3680	6560*	2650		4990*	2360	8061
1.5m (4.11ft)					11880*	4990	8560*	3440	6960*	2540		5350*	2270	8096
0m					12360*	4820	9020*	3300	7140*	2470		6040*	2330	7839
- 1.5m (- 4.11ft)			11640*	8990	11970*	4810	8900*	3270				7050*	2580	7260
- 3.0m (- 9.10ft)			14560*	9210	10630*	4940	7770*	3370				7230*	3210	6266
- 4.5m (- 14.9ft)														

LIFT CAPACITIES – Dipper length: 3.0m, Monoboom 5.1m, No bucket, Rear dozer, 5 T Counterweight.
JS200W MONO

Reach	1.5m (4ft 11in)		3m (9ft 10in)		4.5m (14ft 9in)		6m (19ft 8in)		7.5m (24ft 7in)		Capacity at Max. Reach			
													mm	
Load Point Ht.	kg	kg	kg	kg	kg	kg	kg	kg	kg	kg	kg	kg	mm	
7.5m (24.6ft)												3400*	3400*	6653
6.0m (19.8ft)							5390*	4160	3950*	2790		3200*	2670	7669
4.5m (14.9ft)							6100*	3940	5620*	2720		3160*	2260	8287
3.0m (9.10ft)					9300*	5530	7100*	3650	6090*	2590		3260*	2050	8594
1.5m (4.11ft)					11180*	4980	8090*	3380	6590*	2450		3490*	1970	8627
0m			6370*	6370*	12090*	4710	8740*	3200	6930*	2350		3900*	2000	8388
- 1.5m (- 4.11ft)	7170*	7170*	10860*	8640	12090*	4640	8880*	3120	6880*	2320		4660*	2190	7850
- 3.0m (- 9.10ft)	11690*	11690*	16000*	8840	11190*	4710	8270*	3160				6220*	2630	6944
- 4.5m (- 14.9ft)			12460*	9240	8870*	4950						6850*	3810	5480



Lift capacity front and rear.



Lift capacity full circle.

Notes:

- For lifting capacity including bucket, subtract total weight of bucket or bucket and quickhitch from above values.
- Lifting capacities are based on ISO 10567, that is: 75% of minimum tipping load or 87% of hydraulic lift capacity, whichever is the less. Lifting capacities marked* are based on hydraulic capacity.
- Lift capacities assume that the machine is on firm, level ground.
- Lift capacities may be limited by local regulations. Please refer to your dealer.

LIFT CAPACITIES – Dipper length: 1.91m, TAB 5.35m, No bucket, Front dozer, Rear stabilisers, 4 T Counterweight.
JS200W TAB

Reach	1.5m (4ft 11in)		3m (9ft 10in)		4.5m (14ft 9in)		6m (19ft 8in)		7.5m (24ft 7in)		Capacity at Max. Reach		
													mm
Load Point Ht.	kg	kg	kg	kg	kg	kg	kg	kg	kg	kg	kg	kg	mm
7.5m (24.6ft)					4770*	4770*					4930*	4930*	4730
6.0m (19.8ft)					4650*	4650*	4760*	4760*			4840*	4840*	6140
4.5m (14.9ft)					5720*	5720*	4970*	4970*			4950*	4480	6940
3.0m (9.10ft)					7450*	7450*	5660*	5470			5160*	3970	7341
1.5m (4.11ft)					8920*	7900	6400*	5190			5440*	3800	7412
0m					9580*	7680	6920*	5030			5800*	3930	7161
- 1.5m (- 4.11ft)					9540*	7680	6980*	5010			6250*	4460	6551
- 3.0m (- 9.10ft)													
- 4.5m (- 14.9ft)													

LIFT CAPACITIES – Dipper length: 2.4m, TAB 5.35m, No bucket, Front dozer, Rear stabilisers, 4 T Counterweight.
JS200W TAB

Reach	1.5m (4ft 11in)		3m (9ft 10in)		4.5m (14ft 9in)		6m (19ft 8in)		7.5m (24ft 7in)		Capacity at Max. Reach		
													mm
Load Point Ht.	kg	kg	kg	kg	kg	kg	kg	kg	kg	kg	kg	kg	mm
7.5m (24.6ft)											4500*	4500*	5430
6.0m (19.8ft)							4270*	4270*			4500*	4500*	6687
4.5m (14.9ft)			6790*	6790*	5190*	5190*	4640*	4640*			4630*	4120	7426
3.0m (9.10ft)					6920*	6920*	5390*	5390*	4840*	3960	4840*	3700	7801
1.5m (4.11ft)					8560*	8120	6210*	5320	5220*	3830	5110*	3560	7867
0m					9480*	7790	6840*	5110	5530*	3740	5450*	3650	7632
- 1.5m (- 4.11ft)			12340*	12340*	9700*	7720	7080*	5040			5870*	4050	7065
- 3.0m (- 9.10ft)					9140*	7850					7260*	5740	5543
- 4.5m (- 14.9ft)													

LIFT CAPACITIES – Dipper length: 3.0m, TAB 5.35m, No bucket, Front dozer, Rear stabilisers, 4 T Counterweight.
JS200W TAB

Reach	1.5m (4ft 11in)		3m (9ft 10in)		4.5m (14ft 9in)		6m (19ft 8in)		7.5m (24ft 7in)		Capacity at Max. Reach		
													mm
Load Point Ht.	kg	kg	kg	kg	kg	kg	kg	kg	kg	kg	kg	kg	mm
7.5m (24.6ft)							3730*	3730*			3590*	3590*	6205
6.0m (19.8ft)							3560*	3560*			3270*	3270*	7325
4.5m (14.9ft)					4290*	4290*	4010*	4010*	3980*	3980*	3170*	3170*	8003
3.0m (9.10ft)			9760*	9760*	6010*	6010*	4810*	4810*	4330*	3940	3210*	3210*	8352
1.5m (4.11ft)					7800*	7800*	5710*	5310	4800*	3780	3390*	3140	8413
0m			6900*	6900*	9020*	7760	6470*	5050	5220*	3640	3740*	3200	8194
- 1.5m (- 4.11ft)			11470*	11470*	9530*	7580	6890*	4920	5400*	3590	4390*	3490	7670
- 3.0m (- 9.10ft)					9330*	7630	6770*	4940			5740*	4210	6767
- 4.5m (- 14.9ft)													



Lift capacity front and rear.



Lift capacity full circle.

Notes:

- For lifting capacity including bucket, subtract total weight of bucket or bucket and quickhitch from above values.
- Lifting capacities are based on ISO 10567, that is: 75% of minimum tipping load or 87% of hydraulic lift capacity, whichever is the less. Lifting capacities marked* are based on hydraulic capacity.
- Lift capacities assume that the machine is on firm, level ground.
- Lift capacities may be limited by local regulations. Please refer to your dealer.

LIFT CAPACITIES – Dipper length: 1.91m, TAB 5.35m, No bucket, Rear stabilisers, 4 T Counterweight.
JS200W TAB

Reach	1.5m (4ft 11in)		3m (9ft 10in)		4.5m (14ft 9in)		6m (19ft 8in)		7.5m (24ft 7in)		Capacity at Max. Reach		
													mm
Load Point Ht.	kg	kg	kg	kg	kg	kg	kg	kg	kg	kg	kg	kg	mm
7.5m (24.6ft)					4770*	4770*					4930*	4930*	4730
6.0m (19.8ft)					4650*	4650*	4760*	4450			4840*	4250	6140
4.5m (14.9ft)					5720*	5720*	4970*	4330			4950*	3350	6940
3.0m (9.10ft)					7450*	6170	5660*	4060			5160*	2940	7341
1.5m (4.11ft)					8920*	5630	6400*	3800			5320	2790	7412
0m					9580*	5430	6920*	3640			5540	2870	7161
- 1.5m (- 4.11ft)					9540*	5430	6890*	3620			6250*	3250	6551
- 3.0m (- 9.10ft)													
- 4.5m (- 14.9ft)													

LIFT CAPACITIES – Dipper length: 2.4m, TAB 5.35m, No bucket, Rear stabilisers, 4 T Counterweight.
JS200W TAB

Reach	1.5m (4ft 11in)		3m (9ft 10in)		4.5m (14ft 9in)		6m (19ft 8in)		7.5m (24ft 7in)		Capacity at Max. Reach		
													mm
Load Point Ht.	kg	kg	kg	kg	kg	kg	kg	kg	kg	kg	kg	kg	mm
7.5m (24.6ft)											4500*	4500*	5430
6.0m (19.8ft)							4270*	4270*			4500*	3810	6687
4.5m (14.9ft)			6790*	6790*	5190*	5190*	4640*	4510			4630*	3100	7426
3.0m (9.10ft)					6920*	6450	5390*	4210	4840*	2960	4840*	2760	7801
1.5m (4.11ft)					8560*	5840	6210*	3920	5220*	2830	4920	2630	7867
0m					9480*	5540	6840*	3720	5210	2740	5080	2680	7632
- 1.5m (- 4.11ft)			12340*	10620	9700*	5470	7080	3660			5680	2970	7065
- 3.0m (- 9.10ft)					9140*	5580					7260*	4170	5543
- 4.5m (- 14.9ft)													

LIFT CAPACITIES – Dipper length: 3.0m, TAB 5.35m, No bucket, Rear stabilisers, 4 T Counterweight.
JS200W TAB

Reach	1.5m (4ft 11in)		3m (9ft 10in)		4.5m (14ft 9in)		6m (19ft 8in)		7.5m (24ft 7in)		Capacity at Max. Reach		
													mm
Load Point Ht.	kg	kg	kg	kg	kg	kg	kg	kg	kg	kg	kg	kg	mm
7.5m (24.6ft)							3730*	3730*			3590*	3590*	6205
6.0m (19.8ft)							3560*	3560*			3270*	3240	7325
4.5m (14.9ft)					4290*	4290*	4010*	4010*	3980*	3070	3170*	2690	8003
3.0m (9.10ft)			9760*	9760*	6010*	6010*	4810*	4230	4330*	2930	3210*	2410	8352
1.5m (4.11ft)					7800*	5920	5710*	3900	4800*	2770	3390*	2290	8413
0m			6900*	6900*	9020*	5490	6470*	3650	5110	2640	3740*	2320	8194
- 1.5m (- 4.11ft)			11470*	10340	9530*	5330	6890*	3530	5060	2600	4390*	2520	7670
- 3.0m (- 9.10ft)					9330*	5090	6770*	3560			5740	3050	6767
- 4.5m (- 14.9ft)													



Lift capacity front and rear.



Lift capacity full circle.

Notes:

- For lifting capacity including bucket, subtract total weight of bucket or bucket and quickhitch from above values.
- Lifting capacities are based on ISO 10567, that is: 75% of minimum tipping load or 87% of hydraulic lift capacity, whichever is the less. Lifting capacities marked* are based on hydraulic capacity.
- Lift capacities assume that the machine is on firm, level ground.
- Lift capacities may be limited by local regulations. Please refer to your dealer.

LIFT CAPACITIES – Dipper length: 1.91m, TAB 5.35m, No bucket, 4 stabilisers, 4 T Counterweight.
JS200W TAB

Reach	1.5m (4ft 11in)		3m (9ft 10in)		4.5m (14ft 9in)		6m (19ft 8in)		7.5m (24ft 7in)		Capacity at Max. Reach		
													mm
Load Point Ht.	kg	kg	kg	kg	kg	kg	kg	kg	kg	kg	kg	kg	mm
7.5m (24.6ft)					4770*	4770*					4930*	4930*	4730
6.0m (19.8ft)					4650*	4650*	4760*	4760*			4840*	4840*	6140
4.5m (14.9ft)					5720*	5720*	4970*	4970*			4950*	4950*	6940
3.0m (9.10ft)					7450*	7450*	5660*	5660*			5160*	5020	7341
1.5m (4.11ft)					8920*	8920*	6400*	6400*			5440*	4830	7412
0m					9580*	9580*	6920*	6470			5800*	5010	7161
- 1.5m (- 4.11ft)					9540*	9540*	6980*	6450			6250*	5710	6551
- 3.0m (- 9.10ft)													
- 4.5m (- 14.9ft)													

LIFT CAPACITIES – Dipper length: 2.4m, TAB 5.35m, No bucket, 4 stabilisers, 4 T Counterweight.
JS200W TAB

Reach	1.5m (4ft 11in)		3m (9ft 10in)		4.5m (14ft 9in)		6m (19ft 8in)		7.5m (24ft 7in)		Capacity at Max. Reach		
													mm
Load Point Ht.	kg	kg	kg	kg	kg	kg	kg	kg	kg	kg	kg	kg	mm
7.5m (24.6ft)											4500*	4500*	5430
6.0m (19.8ft)							4270*	4270*			4500*	4500*	6687
4.5m (14.9ft)			6790*	6790*	5190*	5190*	4640*	4640*			4630*	4630*	7426
3.0m (9.10ft)					6920*	6920*	5390*	5390*	4840*	4840*	4840*	4660	7801
1.5m (4.11ft)					8560*	8560*	6210*	6210*	5220*	4840	5110*	4500	7867
0m					9480*	9480*	6840*	6560	5530*	4740	5450*	4630	7632
- 1.5m (- 4.11ft)			12340*	12340*	9700*	9700*	7080*	6480			5870*	5150	7065
- 3.0m (- 9.10ft)					9140*	9140*					7260*	7260*	5543
- 4.5m (- 14.9ft)													

LIFT CAPACITIES – Dipper length: 3.0m, TAB 5.35m, No bucket, 4 stabilisers, 4 T Counterweight.
JS200W TAB

Reach	1.5m (4ft 11in)		3m (9ft 10in)		4.5m (14ft 9in)		6m (19ft 8in)		7.5m (24ft 7in)		Capacity at Max. Reach		
													mm
Load Point Ht.	kg	kg	kg	kg	kg	kg	kg	kg	kg	kg	kg	kg	mm
7.5m (24.6ft)							3730*	3730*			3590*	3590*	6205
6.0m (19.8ft)							3560*	3560*			3270*	3270*	7325
4.5m (14.9ft)					4290*	4290*	4010*	4010*	3980*	3980*	3170*	3170*	8003
3.0m (9.10ft)			9760*	9760*	6010*	6010*	4810*	4810*	4330*	4330*	3210*	3210*	8352
1.5m (4.11ft)					7800*	7800*	5710*	5710*	4800*	4790	3390*	3390*	8413
0m			6900*	6900*	9020*	9020*	6470*	6470*	5220*	4650	3740*	3740*	8194
- 1.5m (- 4.11ft)			11470*	11470*	9530*	9530*	6890*	6360	5400*	4600	4390*	4390*	7670
- 3.0m (- 9.10ft)					9330*	9330*	6770*	6380			5740*	5390	6767
- 4.5m (- 14.9ft)													



Lift capacity front and rear.



Lift capacity full circle.

Notes:

- For lifting capacity including bucket, subtract total weight of bucket or bucket and quickhitch from above values.
- Lifting capacities are based on ISO 10567, that is: 75% of minimum tipping load or 87% of hydraulic lift capacity, whichever is the less. Lifting capacities marked* are based on hydraulic capacity.
- Lift capacities assume that the machine is on firm, level ground.
- Lift capacities may be limited by local regulations. Please refer to your dealer.

LIFT CAPACITIES – Dipper length: 1.91m, TAB 5.35m, No bucket, Rear dozer, 4 T Counterweight.
JS200W TAB

Reach	1.5m (4ft 11in)		3m (9ft 10in)		4.5m (14ft 9in)		6m (19ft 8in)		7.5m (24ft 7in)		Capacity at Max. Reach		
													mm
Load Point Ht.	kg	kg	kg	kg	kg	kg	kg	kg	kg	kg	kg	kg	mm
7.5m (24.6ft)					4770*	4770*					4930*	4930*	4730
6.0m (19.8ft)					4650*	4650*	4760*	3490			4840*	3320	6140
4.5m (14.9ft)					5720*	5350	4970*	3370			4950*	2580	6940
3.0m (9.10ft)					7450*	4680	5660*	3110			5160*	2230	7341
1.5m (4.11ft)					8920*	4170	6400*	2860			5440*	2090	7412
0m					9580*	3980	6920*	2710			5800*	2140	7161
- 1.5m (- 4.11ft)					9540*	3980	6980*	2690			6250*	2430	6551
- 3.0m (- 9.10ft)													
- 4.5m (- 14.9ft)													

LIFT CAPACITIES – Dipper length: 2.4m, TAB 5.35m, No bucket, Rear dozer, 4 T Counterweight.
JS200W TAB

Reach	1.5m (4ft 11in)		3m (9ft 10in)		4.5m (14ft 9in)		6m (19ft 8in)		7.5m (24ft 7in)		Capacity at Max. Reach		
													mm
Load Point Ht.	kg	kg	kg	kg	kg	kg	kg	kg	kg	kg	kg	kg	mm
7.5m (24.6ft)											4500*	4350	5430
6.0m (19.8ft)							4270*	3700			4500*	2990	6687
4.5m (14.9ft)			6790*	6790*	5190*	5190*	4640*	3540			4630*	2400	7426
3.0m (9.10ft)					6920*	4940	5390*	3260	4840*	2270	4840*	2100	7801
1.5m (4.11ft)					8560*	4370	6210*	2980	5220*	2150	5110*	1980	7867
0m					9480*	4090	6840*	2790	5530*	2060	5450*	2010	7632
- 1.5m (- 4.11ft)			12340*	7490	9700*	4020	7080*	2730			5870*	2230	7065
- 3.0m (- 9.10ft)					9140*	4130					7260*	3120	5543
- 4.5m (- 14.9ft)													

LIFT CAPACITIES – Dipper length: 3.0m, TAB 5.35m, No bucket, Rear dozer, 4 T Counterweight.
JS200W TAB

Reach	1.5m (4ft 11in)		3m (9ft 10in)		4.5m (14ft 9in)		6m (19ft 8in)		7.5m (24ft 7in)		Capacity at Max. Reach		
													mm
Load Point Ht.	kg	kg	kg	kg	kg	kg	kg	kg	kg	kg	kg	kg	mm
7.5m (24.6ft)							3760*	3740*			3570*	3490	6205
6.0m (19.8ft)							3580*	3580*			3250*	2540	7325
4.5m (14.9ft)					4320*	4320*	4050*	3600	4030*	2400	3150*	2090	8003
3.0m (9.10ft)			9880*	9330	6080*	5140	4870*	3310	4380*	2280	3190*	1850	8352
1.5m (4.11ft)					7900*	4520	5790*	3010	4860*	2130	3370*	1740	8413
0m			6880*	6880*	9140*	4140	6550*	2790	5290*	2010	3730*	1760	8194
- 1.5m (- 4.11ft)			11440*	7430	9650*	4000	6980*	2680	5470*	1970	4380*	1910	7670
- 3.0m (- 9.10ft)					9450*	4030	6860*	2700			5730*	2320	6767
- 4.5m (- 14.9ft)													



Lift capacity front and rear.



Lift capacity full circle.

Notes:

- For lifting capacity including bucket, subtract total weight of bucket or bucket and quickhitch from above values.
- Lifting capacities are based on ISO 10567, that is: 75% of minimum tipping load or 87% of hydraulic lift capacity, whichever is the less. Lifting capacities marked* are based on hydraulic capacity.
- Lift capacities assume that the machine is on firm, level ground.
- Lift capacities may be limited by local regulations. Please refer to your dealer.

LIFT CAPACITIES – Dipper length: 1.91m, TAB 5.35m, No bucket, Front dozer, Rear stabilisers, 3.5 T Counterweight.
JS200W TAB

Reach	1.5m (4ft 11in)		3m (9ft 10in)		4.5m (14ft 9in)		6m (19ft 8in)		7.5m (24ft 7in)		Capacity at Max. Reach		
													mm
Load Point Ht.	kg	kg	kg	kg	kg	kg	kg	kg	kg	kg	kg	kg	mm
7.5m (24.6ft)					4770*	4770*					4930*	4930*	4730
6.0m (19.8ft)					4650*	4650*	4760*	4760*			4840*	4840*	6140
4.5m (14.9ft)					5720*	5720*	4970*	4970*			4950*	4220	6940
3.0m (9.10ft)					7450*	7450*	5660*	5160			5160*	3730	7341
1.5m (4.11ft)					8920*	7440	6400*	4880			5440*	3570	7412
0m					9580*	7210	6920*	4720			5800*	3690	7161
- 1.5m (- 4.11ft)					9540*	7210	6980*	4700			6250*	4190	6551
- 3.0m (- 9.10ft)													
- 4.5m (- 14.9ft)													

LIFT CAPACITIES – Dipper length: 2.4m, TAB 5.35m, No bucket, Front dozer, Rear stabilisers, 3.5 T Counterweight.
JS200W TAB

Reach	1.5m (4ft 11in)		3m (9ft 10in)		4.5m (14ft 9in)		6m (19ft 8in)		7.5m (24ft 7in)		Capacity at Max. Reach		
													mm
Load Point Ht.	kg	kg	kg	kg	kg	kg	kg	kg	kg	kg	kg	kg	mm
7.5m (24.6ft)											4500*	4500*	5430
6.0m (19.8ft)							4270*	4270*			4500*	4500*	6687
4.5m (14.9ft)			6790*	6790*	5190*	5190*	4640*	4640*			4630*	3890	7426
3.0m (9.10ft)					6920*	6920*	5390*	5320	4840*	3730	4840*	3480	7801
1.5m (4.11ft)					8560*	7660	6210*	5010	5220*	3600	5110*	3340	7632
0m					9480*	7330	6840*	4800	5530*	3510	5450*	3420	7632
- 1.5m (- 4.11ft)			12340*	12340*	9700*	7250	7080*	4730			5870*	3800	7065
- 3.0m (- 9.10ft)					9140*	7380					7260*	5400	5543
- 4.5m (- 14.9ft)													

LIFT CAPACITIES – Dipper length: 3.0m, TAB 5.35m, No bucket, Front dozer, Rear stabilisers, 3.5 T Counterweight.
JS200W TAB

Reach	1.5m (4ft 11in)		3m (9ft 10in)		4.5m (14ft 9in)		6m (19ft 8in)		7.5m (24ft 7in)		Capacity at Max. Reach		
													mm
Load Point Ht.	kg	kg	kg	kg	kg	kg	kg	kg	kg	kg	kg	kg	mm
7.5m (24.6ft)							3730*	3730*			3590*	3590*	6205
6.0m (19.8ft)							3560*	3560*			3270*	3270*	7325
4.5m (14.9ft)					4290*	4290*	4010*	4010*	3980*	3850	3170*	3170*	8003
3.0m (9.10ft)			9760*	9760*	6010*	6010*	4810*	4810*	4330*	3710	3210*	3070	8352
1.5m (4.11ft)					7800*	7760	5710*	5000	4800*	3550	3390*	2940	8413
0m			6900*	6900*	9020*	7290	6470*	4740	5220*	3410	3740*	2990	8194
- 1.5m (- 4.11ft)			11470*	11470*	9530*	7120	6890*	4610	5400*	3360	4390*	3260	7670
- 3.0m (- 9.10ft)					9330*	7160	6770*	4630			5740*	3940	6767
- 4.5m (- 14.9ft)													



Lift capacity front and rear.



Lift capacity full circle.

Notes:

- For lifting capacity including bucket, subtract total weight of bucket or bucket and quickhitch from above values.
- Lifting capacities are based on ISO 10567, that is: 75% of minimum tipping load or 87% of hydraulic lift capacity, whichever is the less. Lifting capacities marked* are based on hydraulic capacity.
- Lift capacities assume that the machine is on firm, level ground.
- Lift capacities may be limited by local regulations. Please refer to your dealer.

LIFT CAPACITIES – Dipper length: 1.91m, TAB 5.35m, No bucket, Rear stabilisers, 3.5 T Counterweight.
JS200W TAB

Reach	1.5m (4ft 11in)		3m (9ft 10in)		4.5m (14ft 9in)		6m (19ft 8in)		7.5m (24ft 7in)		Capacity at Max. Reach		
													mm
Load Point Ht.	kg	kg	kg	kg	kg	kg	kg	kg	kg	kg	kg	kg	mm
7.5m (24.6ft)					4770*	4770*					4930*	4930*	4730
6.0m (19.8ft)					4650*	4650*	4760*	4180			4840*	3990	6140
4.5m (14.9ft)					5720*	5720*	4970*	4070			4950*	3120	6940
3.0m (9.10ft)					7450*	5770	5660*	3790			5160*	2730	7341
1.5m (4.11ft)					8920*	5240	6400*	3530			5030	2580	7412
0m					9580*	5030	6850	3370			5230	2650	7161
- 1.5m (- 4.11ft)					9540*	5040	6830	3350			6000	3010	6551
- 3.0m (- 9.10ft)													
- 4.5m (- 14.9ft)													

LIFT CAPACITIES – Dipper length: 2.4m, TAB 5.35m, No bucket, Rear stabilisers, 3.5 T Counterweight.
JS200W TAB

Reach	1.5m (4ft 11in)		3m (9ft 10in)		4.5m (14ft 9in)		6m (19ft 8in)		7.5m (24ft 7in)		Capacity at Max. Reach		
													mm
Load Point Ht.	kg	kg	kg	kg	kg	kg	kg	kg	kg	kg	kg	kg	mm
7.5m (24.6ft)											4500*	4500*	5430
6.0m (19.8ft)							4270*	4270*			4500*	3570	6687
4.5m (14.9ft)			6790*	6790*	5190*	5190*	4640*	4240			4630*	2890	7426
3.0m (9.10ft)					6920*	6060	5390*	3940	4840*	2750	4820	2560	7801
1.5m (4.11ft)					8560*	5440	6210*	3650	5020	2630	4650	2430	7867
0m					9480*	5140	6840*	3450	4920	2540	4790	2480	7632
- 1.5m (- 4.11ft)			12340*	9880	9700*	5070	6850	3390			5370	2750	7065
- 3.0m (- 9.10ft)					9140	5190					7260*	3870	5543
- 4.5m (- 14.9ft)													

LIFT CAPACITIES – Dipper length: 3.0m, TAB 5.35m, No bucket, Rear stabilisers, 3.5 T Counterweight.
JS200W TAB

Reach	1.5m (4ft 11in)		3m (9ft 10in)		4.5m (14ft 9in)		6m (19ft 8in)		7.5m (24ft 7in)		Capacity at Max. Reach		
													mm
Load Point Ht.	kg	kg	kg	kg	kg	kg	kg	kg	kg	kg	kg	kg	mm
7.5m (24.6ft)							3730*	3730*			3590*	3590*	6205
6.0m (19.8ft)							3560*	3560*			3270*	3030	7325
4.5m (14.9ft)					4290*	4290*	4010*	4010*	3980*	2860	3170*	2500	8003
3.0m (9.10ft)			9760*	9760*	6010*	6010*	4810*	3960	4330*	2730	3210*	2230	8352
1.5m (4.11ft)					7800*	5520	5710*	3630	4800*	2570	3390*	2110	8413
0m			6900*	6900*	9020*	5100	6470	3390	4820	2440	3740*	2130	8194
- 1.5m (- 4.11ft)			11470*	9600	9530*	4940	6720	3260	4770	2390	4390*	2320	7670
- 3.0m (- 9.10ft)					9330*	4980	6750	3290			5640	2820	6767
- 4.5m (- 14.9ft)													



Lift capacity front and rear.



Lift capacity full circle.

Notes:

- For lifting capacity including bucket, subtract total weight of bucket or bucket and quickhitch from above values.
- Lifting capacities are based on ISO 10567, that is: 75% of minimum tipping load or 87% of hydraulic lift capacity, whichever is the less. Lifting capacities marked* are based on hydraulic capacity.
- Lift capacities assume that the machine is on firm, level ground.
- Lift capacities may be limited by local regulations. Please refer to your dealer.

LIFT CAPACITIES – Dipper length: 1.91m, TAB 5.35m, No bucket, 4 stabilisers, 3.5 T Counterweight.
JS200W TAB

Reach	1.5m (4ft 11in)		3m (9ft 10in)		4.5m (14ft 9in)		6m (19ft 8in)		7.5m (24ft 7in)		Capacity at Max. Reach		
													mm
Load Point Ht.	kg	kg	kg	kg	kg	kg	kg	kg	kg	kg	kg	kg	mm
7.5m (24.6ft)					4770*	4770*					4930*	4930*	4730
6.0m (19.8ft)					4650*	4650*	4760*	4760*			4840*	4840*	6140
4.5m (14.9ft)					5720*	5720*	4970*	4970*			4950*	4950*	6940
3.0m (9.10ft)					7450*	7450*	5660*	5660*			5160*	4750	7341
1.5m (4.11ft)					8920*	8920*	6400*	6300			5440*	4570	7412
0m					9580*	9580*	6920*	6120			5800*	4740	7161
- 1.5m (- 4.11ft)					9540*	9540*	6980*	6100			6250*	5400	6551
- 3.0m (- 9.10ft)													
- 4.5m (- 14.9ft)													

LIFT CAPACITIES – Dipper length: 2.4m, TAB 5.35m, No bucket, 4 stabilisers, 3.5 T Counterweight.
JS200W TAB

Reach	1.5m (4ft 11in)		3m (9ft 10in)		4.5m (14ft 9in)		6m (19ft 8in)		7.5m (24ft 7in)		Capacity at Max. Reach		
													mm
Load Point Ht.	kg	kg	kg	kg	kg	kg	kg	kg	kg	kg	kg	kg	mm
7.5m (24.6ft)							4270*	4270*			4500*	4500*	5430
6.0m (19.8ft)											4500*	4500*	6687
4.5m (14.9ft)			6790*	6790*	5190*	5190*	4640*	4640*			4630*	4630*	7426
3.0m (9.10ft)					6920*	6920*	5390*	5390*	4840*	4720	4840*	4410	7801
1.5m (4.11ft)					8560*	8560*	6210*	6210*	5220*	4580	5110*	4250	7867
0m					9480*	9480*	6840*	6210	5530*	4490	5450*	4380	7632
- 1.5m (- 4.11ft)			12340*	12340*	9700*	9660	7080*	6130			5870*	4870	7065
- 3.0m (- 9.10ft)					9140*	9140*					7260	7020	5543
- 4.5m (- 14.9ft)													

LIFT CAPACITIES – Dipper length: 3.0m, TAB 5.35m, No bucket, 4 stabilisers, 3.5 T Counterweight.
JS200W TAB

Reach	1.5m (4ft 11in)		3m (9ft 10in)		4.5m (14ft 9in)		6m (19ft 8in)		7.5m (24ft 7in)		Capacity at Max. Reach		
													mm
Load Point Ht.	kg	kg	kg	kg	kg	kg	kg	kg	kg	kg	kg	kg	mm
7.5m (24.6ft)							3730*	3730*			3590*	3590*	6205
6.0m (19.8ft)							3560*	3560*			3270*	3270*	7325
4.5m (14.9ft)					4290*	4290*	4010*	4010*	3980*	3980*	3170*	3170*	8003
3.0m (9.10ft)			9760*	9760*	6010*	6010*	4810*	4810*	4330*	4330*	3210*	3210*	8352
1.5m (4.11ft)					7800*	7800*	5710*	5710*	4800*	4530	3390*	3390*	8413
0m			6900*	6900*	9020*	9020*	6470*	6150	5220*	4390	3740*	3740*	8194
- 1.5m (- 4.11ft)			11470*	11470*	9530*	9520	6890*	6010	5400*	4340	4390*	4210	7670
- 3.0m (- 9.10ft)					9330*	9330*	6770*	6040			5740*	5090	6767
- 4.5m (- 14.9ft)													



Lift capacity front and rear.



Lift capacity full circle.

Notes:

- For lifting capacity including bucket, subtract total weight of bucket or bucket and quickhitch from above values.
- Lifting capacities are based on ISO 10567, that is: 75% of minimum tipping load or 87% of hydraulic lift capacity, whichever is the less. Lifting capacities marked* are based on hydraulic capacity.
- Lift capacities assume that the machine is on firm, level ground.
- Lift capacities may be limited by local regulations. Please refer to your dealer.

LIFT CAPACITIES – Dipper length: 1.91m, TAB 5.35m, No bucket, Rear dozer, 3.5 T Counterweight.
JS200W TAB

Reach	1.5m (4ft 11in)		3m (9ft 10in)		4.5m (14ft 9in)		6m (19ft 8in)		7.5m (24ft 7in)		Capacity at Max. Reach		
													mm
Load Point Ht.	kg	kg	kg	kg	kg	kg	kg	kg	kg	kg	kg	kg	mm
7.5m (24.6ft)					4770*	4770*					4930*	4930*	4730
6.0m (19.8ft)					4650*	4650*	4760*	3250			4840*	3090	6140
4.5m (14.9ft)					5720*	5000	4970*	3130			4950*	2370	6940
3.0m (9.10ft)					7450*	4330	5660*	2870			5160*	2040	7341
1.5m (4.11ft)					8920*	3830	6400*	2620			5440*	1910	7412
0m					9580*	3630	6920*	2470			5800*	1950	7161
- 1.5m (- 4.11ft)					9540*	3640	6980*	2450			6250*	2210	6551
- 3.0m (- 9.10ft)													
- 4.5m (- 14.9ft)													

LIFT CAPACITIES – Dipper length: 2.4m, TAB 5.35m, No bucket, Rear dozer, 3.5 T Counterweight.
JS200W TAB

Reach	1.5m (4ft 11in)		3m (9ft 10in)		4.5m (14ft 9in)		6m (19ft 8in)		7.5m (24ft 7in)		Capacity at Max. Reach		
													mm
Load Point Ht.	kg	kg	kg	kg	kg	kg	kg	kg	kg	kg	kg	kg	mm
7.5m (24.6ft)											4500*	4080	5430
6.0m (19.8ft)							4270*	3460			4500*	2770	6687
4.5m (14.9ft)			6790*	6790*	5190*	5190*	4640*	3300			4630*	2210	7426
3.0m (9.10ft)					6920*	4600	5390*	3020	4840*	2080	4840*	1930	7801
1.5m (4.11ft)					8560*	4020	6210*	2740	5220*	1960	5110*	1810	7867
0m					9480*	3740	6840*	2550	5530*	1880	5450*	1830	7632
- 1.5m (- 4.11ft)			12340*	6880	9700*	3680	7080*	2490			5870*	2030	7065
- 3.0m (- 9.10ft)					9140*	3790					7260*	2850	5543
- 4.5m (- 14.9ft)													

LIFT CAPACITIES – Dipper length: 3.0m, TAB 5.35m, No bucket, Rear dozer, 3.5 T Counterweight.
JS200W TAB

Reach	1.5m (4ft 11in)		3m (9ft 10in)		4.5m (14ft 9in)		6m (19ft 8in)		7.5m (24ft 7in)		Capacity at Max. Reach		
													mm
Load Point Ht.	kg	kg	kg	kg	kg	kg	kg	kg	kg	kg	kg	kg	mm
7.5m (24.6ft)							3760*	3500			3570*	3260	6205
6.0m (19.8ft)							3580*	3530			3250*	2350	7325
4.5m (14.9ft)					4320*	4320*	4050*	3350	4030*	2210	3150*	1910	8003
3.0m (9.10ft)			9880*	8710	6080*	4790	4870*	3070	4380*	2090	3190*	1580	8352
1.5m (4.11ft)					7900*	4170	5790*	2770	4860*	1950	3370*	1580	8413
0m			6880*	6820*	9140*	3800	6550*	2550	5290*	1830	3730*	1590	8194
- 1.5m (- 4.11ft)			11440*	6810	9650*	3650	6980*	2430	5470*	1780	4380*	1730	7670
- 3.0m (- 9.10ft)					9450*	3690	6860*	2450			5730*	2110	6767
- 4.5m (- 14.9ft)													



Lift capacity front and rear.



Lift capacity full circle.

Notes:

- For lifting capacity including bucket, subtract total weight of bucket or bucket and quickhitch from above values.
- Lifting capacities are based on ISO 10567, that is: 75% of minimum tipping load or 87% of hydraulic lift capacity, whichever is the less. Lifting capacities marked* are based on hydraulic capacity.
- Lift capacities assume that the machine is on firm, level ground.
- Lift capacities may be limited by local regulations. Please refer to your dealer.

A GLOBAL COMMITMENT TO QUALITY

JCB's total commitment to its products and customers has helped it grow from a one-man business into Britain's largest privately owned manufacturer of backhoe loaders, crawler excavators, wheeled excavators, telescopic handlers, wheeled loaders, dump trucks, rough terrain fork lifts, industrial fork lifts, mini/midi excavators, skid steer loaders, tractors and compaction equipment.

By making constant and massive investments in the latest production technology, the JCB factories have become some of the most advanced in the world.

By leading the field in innovative research and design, extensive testing and stringent quality control, JCB machines have become renowned all over the world for performance, value and reliability.

And with a global sales and service network of more than 650 dealers and agents, we aim to deliver the best customer support in the industry.

Through setting the standards by which others are judged, JCB has become one of the world's most impressive success stories.

