

# EZ17

## Tracked Zero Tail Excavators



**WACKER  
NEUSON**  
*all it takes!*



### Compactness in top form

The EZ17 compact excavator is the best performance Zero Tail model in its class. The large volume diesel engine combined with LUDV (Load Sensing System) and the new cooling system promise high performance and efficiency. The compact and robust design ensures longer operating life. The EZ17 guarantees the perfect full 360-vision - upward as well as downward - and offers an extremely large field of vision.

- Best performance Zero Tail model in its class with a large volume diesel engine and LUDV (Load Sensing System).
- Zero tail swing for working in tight and confined spaces.
- New cooling system promise high performance also in high surrounding temperatures of up to 45 °C.
- Compact, robust design ensures longer operating life.
- Extremely large field of vision through top window.

## EZ17 Technical specifications

### Operating data

Shipping weight min.	1,595 kg
Operating weight	1,724 - 1,950 kg
Biting force max.	9.1 kN
Breakout force max.	18.7 kN
Digging depth max.	2,486 mm
Dumping height	2,436 - 2,550 mm
Digging radius max.	4,050 mm
Superstructure slewing speed	10 1/min
L x W x H	3,584 x 990 x 2,362 mm
Tank capacity	22 l

### Engine / Motor

Engine / Motor manufacturer	Yanmar
Engine / Motor type	3TNV76
Engine / Motor	Water-cooled 3-cylinder diesel engine
Emission standards stage	5
Displacement	1,116 cm <sup>3</sup>
RPM / speed	2,200 rpm
Engine performance output to ISO	13.8 kW

### Battery

Battery	44 Ah
---------	-------

### Hydraulic system

Flow rate	39.6 l/min
Operating pressure for working and traction hydraulics	240 bar
Operating pressure Slewing gear	150 bar
Hydraulic oil tank	21 l

### Undercarriage

Travel speed max.	4.8 km/h
Chain width	230 mm
Ground clearance	156 mm

### Dozer Blade

Width	1,300 mm
Height	230 mm

### Sound level

Sound level (LwA) acc. to 2000/14/EC	93 dB(A)
Cabin - specified sound pressure level LpA acc. to ISO 6394	79 dB(A)

## EZ17 Dimensions

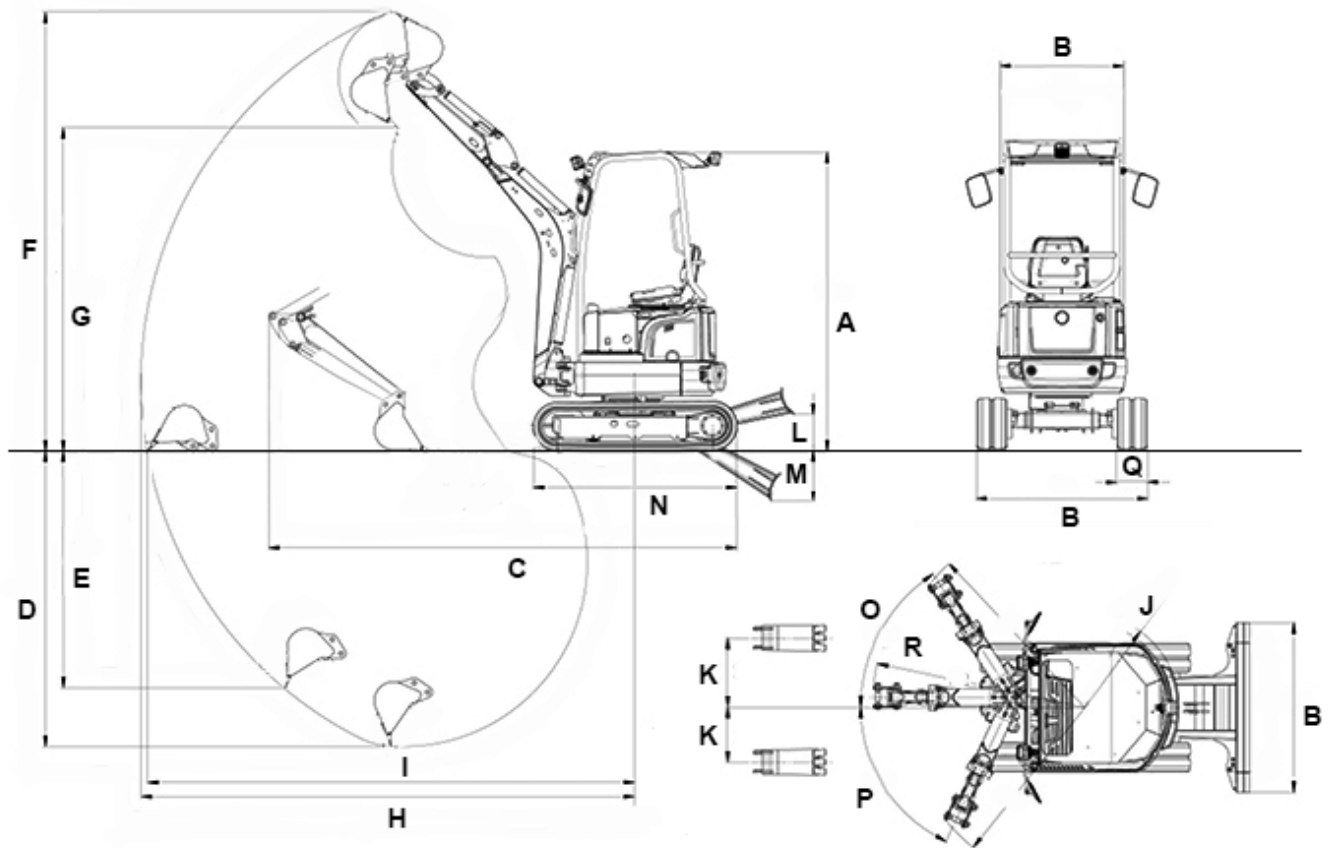

A	Height	2,362 mm
B	Width of canopy	885 mm
B	Width of revolving superstructure	990 mm
B	Width Undercarriage width, retracted	1,300 mm
C	Transport length (short dipper arm)	3,584 mm
C	Transport length (long dipper arm)	3,551 mm
D	Digging depth max. Max. (short dipper arm)	2,326 mm
D	Digging depth max. Max. (long dipper arm)	2,486 mm
E	Insertion depth Max. vertical (short dipper arm)	1,713 mm
E	Insertion depth Max. vertical (long dipper arm)	1,863 mm
F	Insertion height Max. (short dipper arm)	3,462 mm
F	Insertion height Max. (long dipper arm)	3,576 mm
G	Dump height max. Max. (short dipper arm)	2,436 mm
G	Dump height max. Max. (long dipper arm)	2,550 mm
H	Digging radius max. Max. (short dipper arm)	3,899 mm
H	Digging radius max. Max. (long dipper arm)	4,050 mm
I	Range Max. span on the ground (short dipper arm)	3,848 mm
I	Range Max. span on the ground (long dipper arm)	4,002 mm
J	Rear swivel radius Min.	660 mm
K	Arm displacement Max. boom offset to centre of bucket, right side	533 mm

K	Arm displacement Max. boom offset to centre of bucket, left side	418 mm
L	Lift height Max. dozer blade above ground	271 mm
M	Scraping depth Max. dozer blade below ground	390 mm
N	Length Total crawler	1,607 mm
O	Turning angle Max. right	57 °
P	Turning angle Max. left	65 °
Q	Chain width	230 mm
R	Boom slewing radius center	1,627 mm
--	Boom slewing radius right	1,519 mm
--	Boom slewing radius left	1,372 mm
--	Distance bucket and depth dozer blade (long dipper arm)	260 mm
--	Distance bucket and depth dozer blade (short dipper arm)	332 mm
--	Height Dozer blade	230 mm

Please note: that product availability can vary from country to country. It is possible that information / products may not be available in your country. More detailed information on engine power can be found in the operator's manual; the stated power may vary due to specific operating conditions. Subject to alterations and errors excepted. Applicable also to illustrations.  
 Copyright © 2021 Wacker Neuson SE.