

**CRAWLER EXCAVATORS
28 – 66 METRIC TON**

DOOSAN



	Operating Weight	Rated Power Gross
		hp (kW) @ rpm
DX300LC-5	68,764 lb. (31 191 kg)	271 hp (202 kW)
DX350LC-5	80,654 lb. (36 584 kg)	317 hp (237 kW)
DX420LC-5	94,799 lb. (43 000 kg)	345 hp (257 kW)
DX490LC-5	112,203 lb. (50 894 kg)	380 hp (283 kW)
DX530LC-5	116,576 lb. (52 878 kg)	380 hp (283 kW)

A HERITAGE OF DEDICATION



Images of Doosan units may show other than standard equipment or new T4-compliant models.

While Doosan is a relatively young brand in the North American construction equipment market, the organization has a heritage in equipment manufacturing that goes back to 1937. And since 2005, we've grown to become the fifth largest construction equipment manufacturer in the world.



Today, Doosan Infracore Construction Equipment America (DICEA) and its affiliates are industry leaders in the engineering, manufacturing and marketing of construction equipment including:

- Skid-Steer Loaders
- Excavators
- Wheel Loaders
- Articulated Dump Trucks
- Attachments
- Air Compressors
- Lighting Systems
- Generators
- Compact Construction Equipment
- Engine Power Systems

Building Your Tomorrow Today

Beyond its products for the construction industry, Doosan Infracore Support Business (ISB) segments include forklifts, material handling, machine tools, castings, forgings, construction, engineering, power generation, water treatment and desalination, plus renewable energy.

Your North American Partners

With our network of dealers and a company infrastructure that spans North America, we can fully support your equipment from coast to coast.



PERFORMANCE

Take the controls. For every dollar you spend on your equipment, Doosan gives you more. Powerful hydraulic forces with high horsepower and torque characteristics bring superior production. Low-emission engines utilize high pressure common rail electronic fuel injection for superior top-end performance and a strong low-end torque rise. Powerful arm and bucket forces on our excavators allow you to move dirt with ease. Performance is what it's all about; Doosan delivers what you need — and then some.

Arm and Bucket Force

Superior hydraulics deliver ample power to the arm and bucket for digging, loading trucks and more. A one-touch power boost momentarily amplifies your hydraulic power, helping you take on difficult digging conditions that slow other machines down. Add it all up for exceptional productivity.

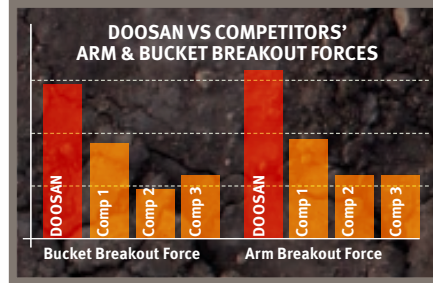

One-Touch Power Boost

The convenient button on the right-hand joystick provides momentary increased hydraulic power to break through hard ground and other tough digging conditions.



Electronic Power Optimizing System (EPOS)

The EPOS works in conjunction with the engine's ECU to monitor and optimize machine performance for increasing productivity while reducing fuel consumption.

Four Power Modes

Selectable power modes give you more control over your excavator's performance. Manage the balance of fuel consumption and machine power to your liking, based on your working conditions.

P+ **Power+ mode** delivers the fastest workgroup speeds to save more time when loading trucks. Top digging performance delivers extra power for digging in hard ground and other tough conditions.

P **Power mode** provides excellent power and superior performance for tough digging and heavy lifting. It also provides quick truck loading and fast travel speed to save time.

S **Standard power mode** optimizes your fuel consumption and delivers high performance in everyday digging, grading and lifting.

E **Economy mode** reduces fuel consumption for low-demand applications and slows down machine movement, which is handy for fine digging, light grading conditions and jobsite conditions that require extra precision.

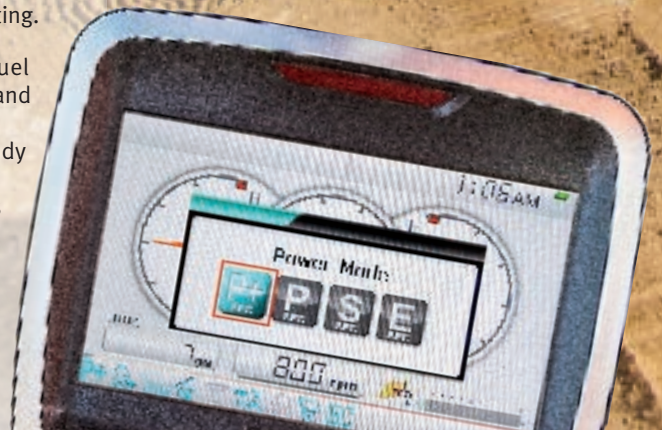



Lifting Capacity

Lift more weight with each cycle and complete the job faster with Doosan excavators designed and tested to maximize lifting capability. With an optimal swing radius, lift height and tilt position, you can lift and place loads and dig with greater productivity.

Swing Torque

New Doosan models have an eight to 11 percent increase in swing torque that allows the excavator to swing uphill with ease – and improve backfilling performance. That means less excavation time per foot of trench.



Fast, powerful and efficient, Doosan excavators are designed to pack more work into the average workday.

Smart Power Control (SPC)

SPC consists of two systems that work together to improve efficiency while maintaining productivity and is controlled by the engine control unit (ECU). Each of the four power modes will function with SPC engaged or disengaged; however, SPC can only be active in the digging work mode.

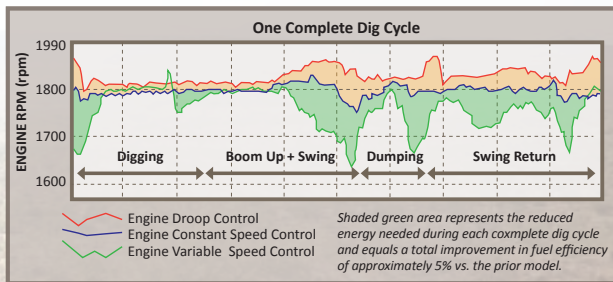

Variable Speed Control reduces engine RPM during low workload requirements, like during the swing portion of a dig cycle. This reduces the energy used to perform a task and improves fuel efficiency by up to five percent.

Pump Torque Control efficiently matches hydraulic pump torque and engine response to the task, preventing engine overload.

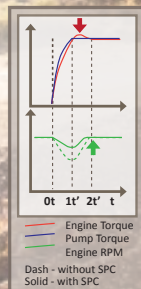

D·ECOPOWER

Improve Productivity and Save Fuel

A pressure-controlled pump, closed-center main control valve and various sensors in the DX350LC-5 electronically detect and control the precise amount of hydraulic oil required to perform a task. The hydraulic system output requirements are optimized with engine horsepower. The resulting efficiency improves productivity and reduces fuel consumption. Improved feedback through the controls results in smoother machine control and enhanced operator comfort.

Tier 4 (T4) Compliant

Optimized to provide more power output with reduced fuel consumption, Doosan excavators are designed with T4 compliant engines to reduce air pollution.



Cooled Exhaust Gas Recirculation (CEGR)

CEGR recycles a portion of the engine exhausts to reduce oxygen (O) and lower the temperature in the combustion chamber. This reduces nitrogen oxide (NO_x) emissions.

Diesel Oxidation Catalyst (DOC)

In the DOC, carbon monoxide (CO) and particulate matter (PM) emissions are transformed into harmless water (H₂O) and carbon dioxide (CO₂).

Evaporative Module

In the evaporative module, or mixing pipe, diesel exhaust fluid (DEF) solution is injected in small doses mixed with hot exhaust gases, decomposing it into urea (CO(NH₂)₂) and water vapor, which then catalyzes into carbon dioxide and ammonia (NH₃).

Selective Catalyst Reduction (SCR)

In the SCR canister, nitrogen oxide (NO_x) mixes with ammonia, and a chemical reaction takes place, resulting in nitrogen (N) and water vapor emitting from the system. The SCR canister also acts as the silencer or muffler.

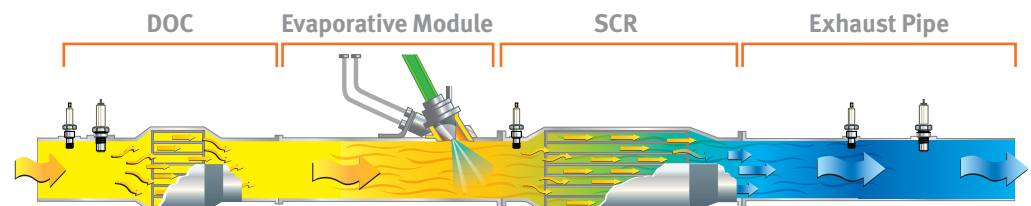



Fast Cycle Times

Two variable displacement axial piston pumps deliver superior cycle times while hydraulic flow regeneration maximizes efficiency.

Auto Idle

To reduce noise, improve jobsite communications and save fuel, the standard auto idle feature idles your engine automatically when machine functions are not used for a few seconds. When you move the controls, the excavator automatically returns to your previous throttle setting.

Auto Downshift

When turning, pushing and maneuvering, auto downshift reduces the hydraulic flow to the drive system – improving machine responsiveness and controllability. When the load decreases, the excavator automatically shifts back into high range.

Diesel Exhaust Fluid (DEF)

DEF is a solution of pure urea and deionized water. A minimum level of DEF is required for proper machine operation, and the DEF supply tank is heated for proper operation in cold weather. DEF is available from your Doosan dealer in various container sizes.

DEF Tank



X-Chassis Undercarriage

Get increased ground clearance and maneuverability in softer ground with the X-Chassis undercarriage design. The sloped surfaces also shed debris faster, reducing material buildup and cutting back your cleanup time.

DURABILITY / RELIABILITY

Like you, Doosan excavators are ready to keep at it until the job is finished. They're protected with solid construction and heavy-duty features that keep you running longer – so you can make more money working and spend less downtime in the shop.



D-Channel Frame Design

This innovative upper structure frame design adds strength to withstand more side shock, protecting your machine's vital components.

Air-to-Air Fuel Cooler

The air-to-air fuel cooler reduces fuel temperature to increase your machine's overall efficiency and protect engine components.

Split Cooling

The split cooling system allows the oil cooler and radiator to operate independently to optimize the hydraulic system and engine temperatures, even in severe working conditions. The system increases cooling capacity while protecting and extending the life of engine components.

Variable Speed Hydraulic Cooling Fan

The hydraulic oil cooler on the DX300LC-5 and larger machines utilizes the variable speed cooling fan. The speed of the fan changes as required by the demands of your excavator. In tough, difficult applications, the fan runs faster for optimized cooling. When you're in lighter duty conditions, the fan runs slower to increase efficiency and reduce noise.

Automatic Belt Tensioner

A spring-applied automatic belt compensates for regular wear and maintains a constant tension on the engine accessory belt.





Heavy Duty Wear Plates

Ultra-hard and wear-resistant, these plates at the end of your arm and H-link extend the service intervals for your bucket pin-up point. By minimizing the tolerance between the bucket and arm, they maintain high breakout forces and ensure greater productivity.



Permanently Sealed, Lubricated Track Pins

Pin links on Doosan excavator tracks are permanently sealed. They never need greasing. That means you reduce your operating costs and increase your uptime.



Recessed Drive Motors

Drive motors contained and recessed within the track width are protected from potential damage, resulting in more uptime.



Cast Ends and Pin Bosses

All the major pin points on the boom and arm are castings for extra strength in tough working conditions. Plus, additional reinforcement around the bosses and internal gussets gives a long life for the workgroup.

OPERATOR COMFORT

An operator can't push performance to the limit if the cabin isn't comfortable. Doosan knows how essential comfort is for its operators. From its great visibility to its deluxe, adjustable seat, Doosan cabins are easy to enter and exit, give you awesome standard features and bring superior comfort to the job.



Visibility

Sightlines to the work group are essential to operator performance. The large Doosan cabin provides an excellent viewing area on the front and side windows. When loading trucks or working overhead, the overhead window gives you great visibility above the machine. Narrow corner pillars, small

window joints and a wiper mounted on the pillar – instead of on the glass surface – give the operator a better view. Sun shades on the front and top windows shield operators from the sun and reduce eye strain. It's a complete visibility package that allows you to focus on your work instead of struggling to see it.

Other Cabin Features

- Improved floor space for your feet; increased cab space for your legs, arms and head
- 180-degree swinging door
- Wide entry/exit area
- Grab handles
- Standard radio and antenna
- Standard CD player and MP3 player input
- 12 V power port
- Adjustable side window openings for fresh air



Quiet Operation

A complete, sound-isolating cabin seal reduces the noise inside the pressurized cab to an extremely low level. Compartmentalized components reduce noise output outside the cab. Even the cabin frame and seat are designed to absorb vibration and significantly increase operator comfort.

Adjustable Comfort

The standard air suspension seat has multiple adjustment points, allowing you to select the most comfortable position.

- A Control Stand/Seat Base Fore/Aft
- B Control Stand/Seat Move with Suspension
- C Control Stand/Seat Height
- D Seat Fore/Aft
- E Seat Cushion Fore/Aft
- F Seat Cushion Angle
- G Back Recline
- H Lumbar Support
- I Headrest Fore/Aft and Up/Down
- J Control Stands Up/Down
- K Seat Heater

Automotive Style Heat and Air Conditioning

High-capacity heating and cooling vents and an easy-to-control temperature keep you comfortable all year long. Automatic temperature control senses and adjusts to the temperature setting. A memory function returns it to your preferred temperature if you shut the machine off and restart later.

Standard Rearview Camera

Provides the operator with an additional means to view the machine's surroundings, allowing for increased productivity.



Easy-to-Read LCD Display Panel

An easy-to-read LCD display panel is placed within easy view for monitoring critical machine data as well as viewing errors, warnings and the rearview camera display. A big, seven-inch display also switches to a night view. The improved monitor allows operators to review key parameters while viewing the camera display.



EASY MAINTENANCE

Even the best equipment needs regular maintenance. When it's time to take care of your excavator, Doosan makes it easy with onboard diagnostic systems, easy component access plus a standard fleet management system. If you want a long-lasting machine and minimum effort to get it, Doosan delivers everything you need.



Easy Component Access

All Doosan excavators provide ground level access to all filters and easy access to regular inspection points. Access panels are easy to find and open from the top, bottom and sides of the excavator. A large engine bonnet provides plenty of room to reach the top side of the engine, while a hinged belly pan allows access from the bottom. Solid steel side panels provide access to regular daily maintenance items which makes for quick, easy service and a lower cost of operation.



Anti-Skid Plates

The star-shape punched holes in the anti-skid plates provide enhanced access during maintenance.



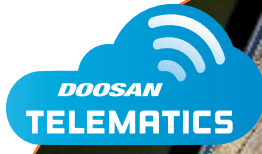

Doosan Telematics

Doosan's Telematics provides machine intelligence through a device that comes standard on all Doosan machines. The device communicates wirelessly through either cellular or satellite communication. Machine information can be viewed via the CoreTMS website, which then allows you to assess various aspects of your Doosan machine.

Key benefits include:

- Review maintenance schedules
- Maximize machine utilization and uptime
- Improve operator efficiency and training
- Monitor fuel use and efficiency
- Receive theft prevention alerts



Oil and Filter Life

Easily review the hours since the last maintenance for oils and filters. Your machine will remind you when each oil and filter needs replacing 10 working hours before service is due, assisting you in regular maintenance scheduling.

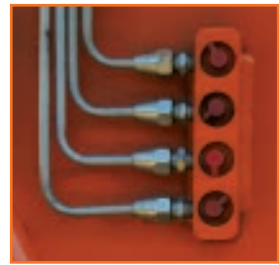
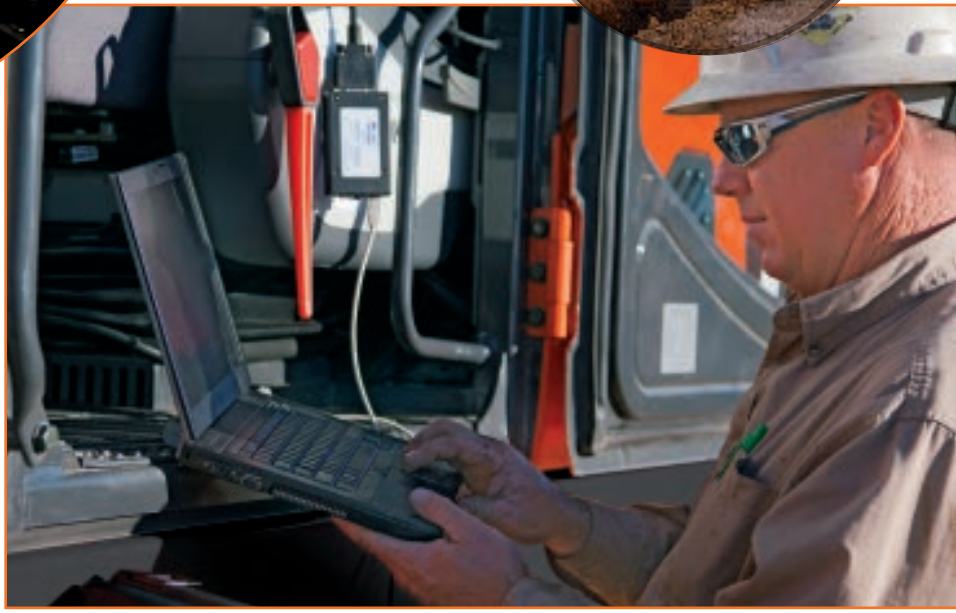

Centralized Arm and Boom Grease Points

Daily maintenance is critical – and it's simple with the centralized grease banks on the arm and base of the boom.

Emergency Stop Switch

The relocated emergency stop switch is now within easy access from the exterior of the machine.



Doosan Monitoring System with Laptop Access

The Doosan Monitoring System is a diagnostic program that gives your dealer's technician a direct communications link with your excavator. During operation, it monitors all critical data and provides a complete history of operation and a real-time log of machine failures. Armed with information like this, your dealer service personnel can fix issues faster — and you can get back to work.

Auxiliary Mode Switch

If needed, an auxiliary mode switch allows you to finish a job or move your excavator to a convenient location for service.

Self-Diagnostics

The LCD monitor helps you monitor critical systems in real time. Plus, you can access historical machine alerts right from the screen in the cabin.



Doosan attachments are designed to match the excavator load ratings and hydraulic performance.

Selectable Work Modes

Four unique work modes enable you to tailor your excavator's performance to the work in front of you. Two modes recalibrate machine power for digging or lifting. Two change the auxiliary hydraulic flow for specific types of attachments. Just change a few settings with the LCD display panel to quickly optimize performance and protect your hydraulic components.

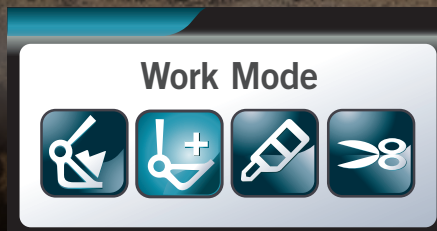

Digging Your default setting delivers the performance you need for general excavation, loading and lifting. The four power modes give it a huge range of versatility for many different digging applications. NOTE: SPC only works in digging mode.

Lifting The increased pump torque, low engine RPMs and automatic power boost provide extra muscle when lifting materials – like pipe or concrete barriers.

Doosan Attachments

Gear up for your job with the hard-working line of Doosan attachments. We build our own tough breakers, clamps, plate compactors and a wide array of bucket types and sizes. All of them are built to Doosan machine specifications for superior reliability and performance.



Plate Compactor



Quick Coupler



Breaker



Hydraulic Attachment Management

Using the LCD screen, the operator can configure 10 different attachment presets: five each for 1-way and 2-way flow. Each preset selection can be matched to specific operational requirements of an attachment by limiting the maximum pressure and the minimum/maximum flow rate that is delivered to the attachment.

When changing hydraulic attachments, the operator can easily select the appropriate preset to optimize machine and attachment functionality. Password protection functionality within the system discourages improper attachment preset selection for operators or rental users with limited understanding of hydraulic systems.

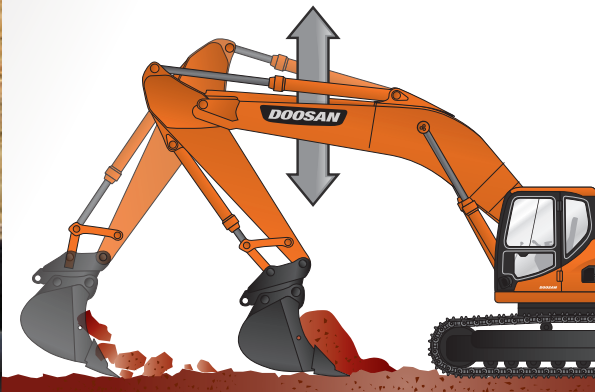

Intelligent Floating Boom

The boom float setting allows the boom to move freely with the contours of the ground. Ideal for finishing work, operators can focus on the arm and bucket. When engaged, the boom does not utilize hydraulic flow, increasing efficiency and productivity by saving fuel and improving cycle times.



Breaker, or one-way auxiliary hydraulic flow, works great for attachments that only require hydraulic power from one direction, such as breakers or plate compactors. This mode also maintains consistent downward pressure for maximum attachment performance and component protection.



Shear, or two-way auxiliary hydraulic flow, is ideal for attachments that need bi-directional hydraulic flow, such as a hydraulic clamp or tilting bucket.

Roller Switch

Easily control and vary the speed at which a two-way hydraulic attachment functions, such as opening and closing a hydraulic clamp, with the roller switch on the right joystick.



General

STANDARD CONFIGURATION

	UNIT	DX300LC-5 STANDARD ARM (US20)	DX350LC-5 STANDARD ARM (US20)	DX420LC-5 STANDARD ARM (US20)	DX490LC-5 STANDARD ARM (US20)	DX530LC-5 MASS EXCAVATION (US20)
ENGINE						
MAKE		Scania	Scania	Scania	Scania	Scania
MODEL		DC09	DC09	DC13	DC13	DC13
NUMBER OF CYLINDERS		5	5	6	6	6
RATED POWER GROSS (HP per SAE J1995)	hp (kW) @ rpm	271 (202) @ 1,800	318 (237) @ 1,800	345 (257) @ 1,800	380 (283) @ 1,800	380 (283) @ 1,800
RATED POWER NET (HP per SAE J1349)	hp (kW) @ rpm	266 (198) @ 1,800	313 (233) @ 1,800	338 (252) @ 1,800	373 (278) @ 1,800	373 (278) @ 1,800
MAXIMUM TORQUE (GROSS) (SAE J1995)	ft.-lb. (Nm) @ rpm	940 (1275) @ 1,300	977 (1324) @ 1,300	1,180 (1599) @ 1,300	1,301 (1764) @ 1,300	1,301 (1764) @ 1,300
PISTON DISPLACEMENT	in ³ (L)	568 (9.3)	568 (9.3)	775 (12.7)	775 (12.7)	775 (12.7)
BORE AND STROKE	in. x in. (mm x mm)	5.1" x 5.5" (130 x 140)	5.1" x 5.5" (130 x 140)	5.1" x 6.3" (130 x 160)	5.1" x 6.3" (130 x 160)	5.1" x 6.3" (130 x 160)
STARTER	V, hp (kW)	24V, 8 (6)	24V, 8 (6)	24V, 8 (6)	24V, 8 (6)	24V, 8 (6)
BATTERY (Qty 2)	V, AH, CCA	12V, 200AH, 1300	12V, 200AH, 1300	12V, 200AH, 1300	12V, 200AH, 1300	12V, 200AH, 1300
ALTERNATOR	V, amp	24V, 100	24V, 100	28V, 100	28V, 100	28V, 100
AIR CLEANER		Double Elements	Double Elements	Double Elements	Double Elements	Double Elements
HYDRAULICS						
MAIN PUMPS	gpm (L/min)	2 x 65.5 (2 x 248)	2 x 92.5 (2 x 350)	2 x 88.5 (2 x 335)	2 x 93.8 (2 x 355)	2 x 93.8 (2 x 355)
PILOT PUMP (Gear Design)	gpm (L/min)	7.1 (27)	6.3 (24)	6.3 (24)	6.3 (24)	6.3 (24)
RELIEF PRESSURE (Normal)	psi (kg/cm ²)	4,978 (350)	5,511 (387.5)	4,694 (330)	4,694 (330)	4,694 (330)
RELIEF PRESSURE (Boost)	psi (kg/cm ²)	5,263 (370)	5,511 (387.5)	4,978 (350)	4,978 (350)	4,978 (350)
MAXIMUM SYSTEM PRESSURE						
BOOM/ARM/BUCKET (Normal Mode)	psi (kg/cm ²)	4,978 (350)	5,511 (387.5)	4,694 (330)	4,694 (330)	4,694 (330)
BOOM/ARM/BUCKET (Power Mode)	psi (kg/cm ²)	5,263 (370)	5,511 (387.5)	4,978 (350)	4,978 (350)	4,978 (350)
TRAVEL (Normal Mode)	psi (kg/cm ²)	4,978 (350)	5,511 (387.5)	4,694 (330)	4,694 (330)	4,694 (330)
TRAVEL (Power Mode)	psi (kg/cm ²)	5,263 (370)	5,511 (387.5)	4,978 (350)	4,978 (350)	4,978 (350)
SWING (Normal Mode)	psi (kg/cm ²)	4,978 (350)	5,511 (387.5)	4,694 (330)	4,694 (330)	4,694 (330)
SWING (Power Mode)	psi (kg/cm ²)	5,263 (370)	5,511 (387.5)	4,978 (350)	4,978 (350)	4,978 (350)
UNDERCARRIAGE						
UPPER ROLLERS (Each Track)		2	2	2	3	3
LOWER ROLLERS (Each Track)		9	9	9	9	9
NUMBER OF SHOES (Links Per Side)		48	48	50	53	53
TOTAL LENGTH OF TRACK	ft. in. (mm)	16'2" (4940)	16'2" (4940)	17'11" (5455)	17'11" (5455)	17'11" (5455)
SWING MECHANISM						
SWING SPEED	rpm	0 - 9.9	0 - 10.5	0 - 8.8	0 - 8.6	0 - 8.6
SWING TORQUE	lbf.ft (kgf.m)	87,787 (12 137)	112,907 (15 610)	118,332 (16 360)	145,600 (20 130)	145,600 (20 130)
DRIVE SYSTEM						
TRAVEL SPEED (Low - High)	mph (km/h)	1.9 - 3.3 (3.0 - 5.3)	2.1 - 3.4 (3.4 - 5.4)	1.9 - 3.2 (3.1 - 5.1)	1.9 - 3.4 (3.1 - 5.4)	1.9 - 3.2 (3.1 - 5.1)
TRACTION FORCE (Drawbar Pull)	lbf.ft (kgf.m)	77,162 (10 668)	83,335 (11 521)	90,169 (12 466)	100,531 (13 899)	100,531 (13 899)
MAXIMUM GRADE	% (°)	70 (35)	70 (35)	70 (35)	70 (35)	70 (35)
ENVIRONMENT						
SOUND LEVEL (2000/14/EC)	dB(A)	103	103	105	105	105
CABIN SOUND LEVEL (ISO 6396)	dB(A)	71	71	72	72	72
REFILL CAPACITIES						
FUEL TANK	gal. (L)	132.1 (500)	158.5 (600)	169.1 (640)	181 (685)	181 (685)
DEF TANK	gal. (L)	18.5 (70)	18.5 (70)	18.5 (70)	18.5 (70)	18.5 (70)
COOLING SYSTEM (Radiator Capacity)	gal. (L)	12.9 (49)	13.7 (52)	13.5 (51)	13.5 (51)	13.5 (51)
ENGINE OIL	gal. (L)	9.5 (36)	9.5 (36)	11.9 (45)	11.9 (45)	11.9 (45)
SWING DRIVE	gal. (L)	1.8 (7)	1.8 (7)	2.1 (8)	2X 1.3 (5)	2X 1.3 (5)
FINAL DRIVE (Each Side)	gal. (L)	1.8 (7)	1.8 (7)	1.8 (7.0)	2.6 (10)	2.6 (10)
HYDRAULIC SYSTEM	gal. (L)	82 (310)	119 (450)	127 (480)	132 (500)	132 (500)
HYDRAULIC TANK	gal. (L)	74 (280)	100 (380)	103 (390)	103 (390)	103 (390)

NOTE — Where applicable, dimensions are in accordance with Society of Automotive Engineers (SAE) and ISO standards. Specifications and design are subject to change without notice. Images of Doosan excavators may show other than standard equipment. All dimensions are shown in inches. Respective metric dimensions are enclosed by parentheses. Doosan equipment is manufactured with a Quality Management System that is in compliance with ISO 9001:2008.

All Dimensions are given for Doosan excavators equipped with standard tracks. Doosan excavators may show other than standard equipment or new T4-compliant models.

Weight

DX300LC-5

		STANDARD ARM (US20)	LONG ARM (US30)	SUPER LONG REACH (US50)
	SHOE SIZE in. (mm)	31.5" (800)	33.5" (850)	33.5" (850)
	COUNTERWEIGHT lb. (mm)	11,684 (5300)	13,889 (6300)	13,889 (6300)
	TRACK TYPE	FIXED	FIXED	FIXED
	UNIT			
Operating Weight	lb. (kg)	68,764 (31 191)	71,300 (32 341)	72,462 (32 868)
Ground Pressure	psi (kgf/cm2)	6.5 (0.46)	6.1 (0.43)	6.1 (0.43)

DX350LC-5

		STANDARD ARM (US20)	LONG ARM (US30)
	SHOE SIZE in. (mm)	31.5" (800)	33.5" (850)
	COUNTERWEIGHT lb. (mm)	15,653 (7100)	15,653 (7100)
	TRACK TYPE	FIXED	FIXED
	UNIT		
Operating Weight	lb. (kg)	80,654 (36 584)	80,769 (36 636)
Ground Pressure	psi (kgf/cm2)	7.5 (0.53)	7.1 (0.5)

DX420LC-5

		STANDARD ARM (US20)	LONG ARM (US30)
	SHOE SIZE in. (mm)	31.5" (800)	35.4" (900)
	COUNTERWEIGHT lb. (mm)	17,637 (8000)	21,605 (9800)
	TRACK TYPE	FIXED	FIXED
	UNIT		
Operating Weight	lb. (kg)	94,799 (43 000)	99,689 (45 218)
Ground Pressure	psi (kgf/cm2)	8.5 (0.6)	7.5 (0.53)

DX490LC-5

		STANDARD ARM (US20)	STANDARD ARM (US30)
	SHOE SIZE in. (mm)	35.4" (900)	35.4" (900)
	COUNTERWEIGHT lb. (mm)	20,283 (9200)	20,283 (9200)
	TRACK TYPE	VARIABLE	FIXED
	UNIT		
Operating Weight	lb. (kg)	112,206 (50 896)	108,900 (49 396)
Ground Pressure	psi (kgf/cm2)	8.4 (0.59)	8.4 (0.59)

DX530LC-5

		STANDARD ARM (US20)	LONG ARM (US30)	SUPER LONG REACH (US50)
	SHOE SIZE in. (mm)	35.4" (900)	35.4" (900)	35.4" (900)
	COUNTERWEIGHT lb. (mm)	24,471 (11 100)	24,471 (11 100)	24,471 (11 100)
	TRACK TYPE	WIDE VARIABLE	WIDE VARIABLE	WIDE VARIABLE
	UNIT			
Operating Weight	lb. (kg)	116,576 (52 878)	116,528 (52 856)	117,112 (53 121)
Ground Pressure	psi (kgf/cm2)	8.8 (0.62)	8.8 (0.62)	8.8 (0.62)

Specifications

Bucket

- 1 Capacity Based on ISO 7451
 - 2 Equipped with Side Cutters
 - 3 Equipped with Bolt-On Teeth
 - 4 Equipped with Bolt-On Cutting Edge
- Maximum Suitable Material Density
- A 3,370 lb./yd³ (2000 kg/m³)
 - B 2,700 lb./yd³ (1600 kg/m³)
 - C 1,850 lb./yd³ (1100 kg/m³)
 - X Not Approved
 - * Based on designed use, not material capacity.

DX300LC-5

BUCKET TYPE	MODEL	CAPACITY ¹ yd ³ (m ³)	WIDTH in. (mm)	WEIGHT lb. (kg)	STANDARD ARM (US20)		LONG ARM (US20)		SUPER LONG REACH (US50)
					BOOM ft.-in. (mm)	ARM ft.-in. (mm)	SHOE SIZE in. (mm)	TRACK TYPE	MOUNT
HEAVY DUTY ^{2,3}	HF50-024	0.67 (0.51)	26 (660)	1,530 (694)	A	A	A	A	X
	HF50-030	0.89 (0.68)	32 (813)	1,709 (775)	A	A	A	A	X
	HF50-036	1.12 (0.86)	38 (965)	1,975 (896)	A	A	A	A	X
	HF50-042	1.36 (1.04)	44 (1118)	2,097 (951)	A	A	A	A	X
	HF50-048	1.61 (1.23)	50 (1270)	2,229 (1011)	A	A	A	A	X
	HF50-054	1.84 (1.41)	56 (1422)	2,423 (1099)	A	B	A	A	X
	HF50-060	2.09 (1.60)	62 (1575)	2,584 (1172)	B	B	A	B	X
	HF40-018	0.27 (0.21)	20 (508)	772 (350)	X	X	X	X	A
	HF40-024	0.41 (0.31)	26 (660)	878 (398)	X	X	X	X	A
	HF40-030	0.55 (0.42)	32 (813)	1013 (459)	X	X	X	X	A
DITCHING ⁴	BS960	1.26 (0.96)	60 (1500)	1,798 (816)	A	A	A	A	X
	BS972	1.54 (1.18)	72 (1829)	1,951 (885)	A	A	A	A	X
	BS984	1.82 (1.39)	84 (2134)	2,369 (1075)	A	B	A	A	X
	BS8B48	0.64 (0.49)	48 (1219)	602 (273)	X	X	X	X	A
	BS8B60	0.80 (0.61)	60 (1524)	908 (412)	X	X	X	X	A
HEAVY DUTY DITCHING	H30BW1850	2.78 (2.13)	73 (1850)	2894 (1313)	C*	C*	C*	C*	X

	STANDARD ARM (US20)		LONG ARM (US30)	
	BOOM ft.-in. (mm)	21' 4" (6500 mm)	21' 4" (6500 mm)	
ARM ft.-in. (mm)	10' 6" (3200 mm)	13' (3950 mm)		
SHOE SIZE in. (mm)	31.5" (800 mm)	33.5" (850 mm)		
TRACK TYPE	FIXED		FIXED	
MOUNT	PIN ON	QUICK COUPLER	PIN ON	QUICK COUPLER

DX350LC-5

BUCKET TYPE	MODEL	CAPACITY ¹ yd ³ (m ³)	WIDTH in. (mm)	WEIGHT lb. (kg)	STANDARD ARM (US20)		LONG ARM (US30)	
					BOOM ft.-in. (mm)	ARM ft.-in. (mm)	SHOE SIZE in. (mm)	TRACK TYPE
HEAVY DUTY ^{2,3}	HF58-030	1.06 (0.81)	32 (813)	2,280 (1034)	A	A	A	A
	HF58-036	1.32 (1.01)	38 (965)	2,530 (1148)	A	A	A	A
	HF58-048	1.88 (1.44)	50 (1270)	3,018 (1369)	A	A	A	A
	HF58-054	2.17 (1.66)	56 (1422)	3,224 (1462)	A	B	B	B
	HF58-060	2.46 (1.88)	62 (1575)	3,443 (1557)	A	B	C	B
DITCHING ⁴	BS960	1.26 (.96)	60 (1524)	1798 (816)	A	A	A	A
	BS972	1.54 (1.18)	72 (1829)	1,951 (885)	A	A	A	A
	BS984	1.82 (1.39)	84 (2134)	2,369 (1075)	A	A	A	B
HEAVY DUTY DITCHING	H38BW1850	3.26 (2.43)	73 (1850)	3668 (1664)	C*	C*	C*	C*

	STANDARD ARM (US20)		LONG ARM (US30)	
	BOOM ft.-in. (mm)	22' (6700)	22' (6700)	
ARM ft.-in. (mm)	10' 8" (3250)	13' (3950)		
SHOE SIZE in. (mm)	31.5" (800)	35.4" (900)		
TRACK TYPE	FIXED		FIXED	
MOUNT	PIN ON	QUICK COUPLER	PIN ON	QUICK COUPLER

DX420LC-5

BUCKET TYPE	MODEL	CAPACITY ¹ yd ³ (m ³)	WIDTH in. (mm)	WEIGHT lb. (kg)	STANDARD ARM (US20)		LONG ARM (US30)	
					BOOM ft.-in. (mm)	ARM ft.-in. (mm)	SHOE SIZE in. (mm)	TRACK TYPE
HEAVY DUTY ^{2,3}	HF60-036	1.50 (1.15)	38 (965)	2,841 (1289)	A	A	A	A
	HF60-048	2.14 (1.64)	50 (1270)	3,382 (1534)	A	A	A	A
	HF60-054	2.51 (1.92)	56 (1422)	3,646 (1654)	A	A	A	A
	HF60-060	2.80 (2.14)	62 (1575)	3,922 (1779)	A	B	A	B
	HF60-066	3.23 (2.47)	68 (1727)	4,387 (1990)	B*	C	B*	C
HEAVY DUTY DITCHING	H30BW1850	3.26 (2.43)	73 (1850)	3788 (1718)	B*	C*	B*	C*

Bucket

	STANDARD ARM (US20)		STANDARD ARM (US30)	
BOOM ft.-in. (mm)	23' 4" (7100)		23' 4" (7100)	
ARM ft.-in. (mm)	11' (3350)		11' (3350)	
SHOE SIZE in. (mm)	35.4" (900)		35.4" (900)	
TRACK TYPE	VARIABLE		FIXED	
MOUNT	PIN ON	QUICK COUPLER	PIN ON	QUICK COUPLER

DX490LC-5

BUCKET TYPE	MODEL	CAPACITY ¹ yd ³ (m ³)	WIDTH in. (mm)	WEIGHT lb. (kg)				
HEAVY DUTY ^{2,3}	HF65-042	2.0 (1.53)	44 (1118)	3,629 (1646)	A	A	A	B
	HF65-048	2.35 (1.80)	50 (1270)	4,015 (1821)	A	A	A	A
	HF65-054	2.71 (2.07)	56 (1422)	4,202 (1906)	A	A	A	A
	HF65-060	3.07 (2.35)	62 (1575)	4,515 (2048)	A	B	A	B
	HF65-066	3.56 (2.72)	68 (1727)	4,963 (2251)	A	C*	B	C*
	HF65-072	3.81 (2.91)	74 (1880)	5,130 (2327)	B	C*	B	C*
HEAVY DUTY DITCHING	H52BW2150	4.84 (3.7)	85 (2150)	5,071 (2301)	C*	C*	C*	C*

	MASS EXCAVATION ARM (US20)	STANDARD ARM (US30)	SUPER LONG REACH (US50)
BOOM ft.-in. (mm)	23' 4" (7100)	23' 4" (7100)	36' 1" (11 000)
ARM ft.-in. (mm)	9' 6" (2900)	11' (3350)	26' 3" (8000)
SHOE SIZE in. (mm)	35.4" (900)	35.4" (900)	35.4" (900)
TRACK TYPE	WIDE VARIABLE	WIDE VARIABLE	WIDE VARIABLE
MOUNT	PIN ON	QUICK COUPLER	PIN ON

DX530LC-5

BUCKET TYPE	MODEL	CAPACITY ¹ yd ³ (m ³)	WIDTH in. (mm)	WEIGHT lb. (kg)					
HEAVY DUTY ^{2,3}	HF65-042	2.0 (1.53)	44 (1118)	3,629 (1646)	A	A	A	A	X
	HF65-048	2.35 (1.80)	50 (1270)	4,015 (1821)	A	A	A	A	X
	HF65-054	2.71 (2.07)	56 (1422)	4,202 (1906)	A	A	A	A	X
	HF65-060	3.07 (2.35)	62 (1575)	4,515 (2048)	A	A	A	A	X
	HF65-066	3.56 (2.72)	68 (1727)	4,963 (2251)	A	A	A	A	X
	HF65-072	3.81 (2.91)	74 (1880)	5,130 (2327)	A	A	A	A	X
	HF50-024	0.67 (0.51)	26 (660)	1,530 (694)	X	X	X	X	A
	HF50-030	0.89 (0.68)	32 (813)	1,709 (775)	X	X	X	X	A
	HF50-036	1.12 (0.86)	38 (965)	1,975 (896)	X	X	X	X	A
	HF50-042	1.36 (1.04)	44 (1118)	2,097 (951)	X	X	X	X	B
	HF50-048	1.61 (1.23)	50 (1270)	2,229 (1011)	X	X	X	X	B
	HF50-054	1.84 (1.41)	56 (1422)	2,423 (1099)	X	X	X	X	C
DITCHING ⁴	BS960	1.26 (0.96)	60 (1500)	1,798 (816)	X	X	X	X	A
	BS972	1.54 (1.18)	72 (1829)	1,951 (885)	X	X	X	X	A
	BS984	1.82 (1.39)	84 (2134)	2,369 (1075)	X	X	X	X	B
HEAVY DUTY DITCHING	H52BW2150	4.84 (3.7)	85 (2150)	5,071 (2301)	B*	C*	B*	C*	X

Hydraulic Cylinders

	UNIT	DX300LC-5	DX350LC-5	DX420LC-5	DX490LC-5	DX530LC-5
BOOM (2)						
BORE x ROD DIAMETER x STROKE (STD & SLR)	in. x in. x in. (mm x mm x mm)	5.5" x 3.7" x 57" (140 x 95 x 1450)	5.9" x 3.9" x 57" (150 x 100 x 1450)	6.7" x 4.5" x 58.5" (170 x 115 x 1485)	6.7" x 4.5" x 65" (170 x 115 x 1650)	6.7" x 4.5" x 65" (170 x 115 x 1650)
ARM (1)						
BORE x ROD DIAMETER x STROKE (STD & SLR)	in. x in. x in. (mm x mm x mm)	5.9" x 4.1" x 66" (150 x 105 x 1670)	6.7" x 4.7" x 71" (170 x 120 x 1805)	7.1" x 4.7" x 71.7" (180 x 120 x 1820)	7.15" x 5.1" x 78" (190 x 130 x 1980)	7.5" x 5.1" x 78" (190 x 130 x 1980)
BUCKET (1)						
BORE x ROD DIAMETER x STROKE (STD)	in. x in. x in. (mm x mm x mm)	5.3" x 3.5" x 45" (135 x 90 x 1150)	5.9" x 3.9" x 51" (150 x 100 x 1300)	6.3" x 4.3" x 52" (160 x 110 x 1320)	6.7" x 4.5" x 53" (170 x 115 x 1341)	6.7" x 4.5" x 53" (170 x 115 x 1341)
BORE x ROD DIAMETER x STROKE (SLR)	in. x in. x in. (mm x mm x mm)	3.7" x 2.6" x 35" (95 x 65 x 900)	—	—	—	4.7" x 3.1" x 42" (120 x 80 x 1 060)

The piston rods and cylinder bodies are made of high-strength steel. A shock-absorbing mechanism is fitted in all cylinders to ensure shock-free operation and extend piston life.

Dimensions

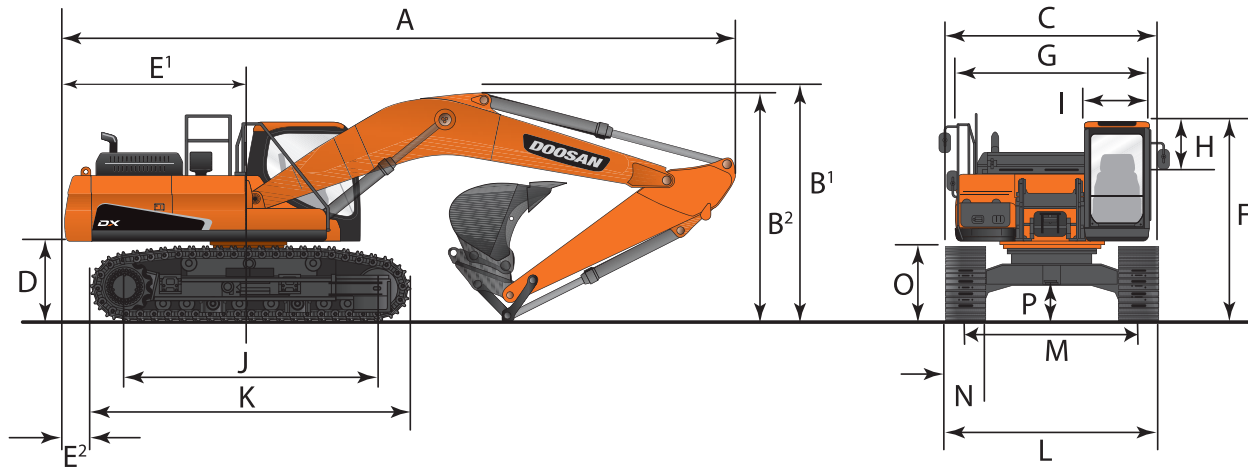

DX300LC-5

			STANDARD ARM (US20)	LONG ARM (US30)	SUPER LONG REACH (US50)
BOOM TYPE		ft.-in. (mm)	20'6" (6245)	20'6" (6245)	32'10" (10 000)
ARM TYPE		ft.-in. (mm)	10'2" (3100)	12'4" (3750)	23'0" (7000)
BUCKET TYPE (SAE)		yd ³ (m ³)	1.66 (1.27)	1.35 (1.03)	0.84 (0.64)
TRACK TYPE			FIXED	FIXED	FIXED
SHIPPING LENGTH	A	ft.-in. (mm)	34' 8" (10 570)	35'0" (10 680)	46' 11" (14 320)
SHIPPING HEIGHT (BOOM)	B ₂	ft.-in. (mm)	10' 8" (3265)	11' 4" (3455)	11' 0" (3365)
SHIPPING HEIGHT (HOSE)	B ₁	ft.-in. (mm)	11' 0" (3370)	11' 8" (3575)	11' 4" (3475)
SHIPPING WIDTH	C	ft.-in. (mm)	11' 1" (3400)	11' 3" (3450)	11' 3" (3450)
COUNTERWEIGHT CLEARANCE	D	ft.-in. (mm)	45.3" (1150)	45.3" (1150)	45.3" (1150)
TAIL SWING RADIUS	E ₁	ft.-in. (mm)	10' 7" (3230)	10' 7" (3230)	10' 7" (3230)
TAIL SWING OVERHANG (REAR)	E ₂	ft.-in. (mm)	29.9" (760)	29.9" (760)	29.9" (760)
TAIL SWING OVERHANG (SIDE)	E ₃ *	ft.-in. (mm)	5' 2" (1580)	5' 1" (1568)	5' 1" (1568)
CABIN HEIGHT	F	ft.-in. (mm)	10' 0" (3065)	10' 0" (3065)	10' 0" (3065)
UPPER STRUCTURE WIDTH	G	ft.-in. (mm)	9' 9" (2960)	9' 9" (2960)	9' 9" (2960)
CABIN HEIGHT ABOVE HOUSE	H	ft.-in. (mm)	33.3" (845)	33.3" (845)	33.3" (845)
CABIN WIDTH	I	ft.-in. (mm)	39.8" (1010)	39.8" (1010)	39.8" (1010)
TUMBLER DISTANCE	J	ft.-in. (mm)	13' 3" (4040)	13' 3" (4040)	13' 3" (4040)
OVERALL TRACK LENGTH	K	ft.-in. (mm)	16' 2" (4940)	16' 2" (4940)	16' 2" (4940)
UNDERCARRIAGE WIDTH	L	ft.-in. (mm)	11' 1" (3400)	11' 3" (3450)	11' 3" (3450)
TRACK GAUGE WIDTH	M	ft.-in. (mm)	6' 6" (1990)	6' 6" (1990)	6' 6" (1990)
TRACK SHOE WIDTH	N	ft.-in. (mm)	31.5" (800)	33.5" (850)	33.5" (850)
TRACK HEIGHT	O	ft.-in. (mm)	41.3" (1048)	41.3" (1048)	41.7" (1058)
CAR BODY CLEARANCE	P	ft.-in. (mm)	19.7" (500)	19.7" (500)	19.9" (505)

DX350LC-5

			STANDARD ARM (US20)	LONG ARM (US30)
BOOM TYPE		ft.-in. (mm)	21'4" (6500)	21'4" (6500)
ARM TYPE		ft.-in. (mm)	10'6" (3200)	13'0" (3950)
BUCKET TYPE (SAE)		yd ³ (m ³)	1.95 (1.49)	1.63 (1.25)
TRACK TYPE			FIXED	FIXED
SHIPPING LENGTH	A	ft.-in. (mm)	37' 1" (11 315)	37' 2" (11 345)
SHIPPING HEIGHT (BOOM)	B ₂	ft.-in. (mm)	10' 8" (3255)	11' 2" (3420)
SHIPPING HEIGHT (HOSE)	B ₁	ft.-in. (mm)	11' 1" (3390)	11' 7" (3550)
SHIPPING WIDTH	C	ft.-in. (mm)	11' 5" (3480)	11' 6" (3530)
COUNTERWEIGHT CLEARANCE	D	ft.-in. (mm)	47" (1195)	47" (1195)
TAIL SWING RADIUS	E ₁	ft.-in. (mm)	11' 6" (3530)	11' 6" (3530)
TAIL SWING OVERHAND (REAR)	E ₂	ft.-in. (mm)	41.7" (1060)	41.7" (1060)
TAIL SWING OVERHAND (SIDE)	E ₃ *	ft.-in. (mm)	5' 10" (1790)	5' 9" (1765)
CABIN HEIGHT	F	ft.-in. (mm)	10' 1" (3080)	10' 1" (3080)
UPPER STRUCTURE WIDTH	G	ft.-in. (mm)	9' 10" (3000)	9' 10" (3000)
CABIN HEIGHT ABOVE HOUSE	H	ft.-in. (mm)	33.3" (845)	33.3" (845)
CABIN WIDTH	I	ft.-in. (mm)	39.8" (1010)	39.8" (1010)
TUMBLER DISTANCE	J	ft.-in. (mm)	13' 3" (4040)	13' 3" (4040)
OVERALL TRACK LENGTH	K	ft.-in. (mm)	16' 2" (4940)	16' 2" (4940)
UNDERCARRIAGE WIDTH	L	ft.-in. (mm)	11' 5" (3480)	11' 6" (3530)
TRACK GAUGE WIDTH	M	ft.-in. (mm)	6' 6" (1990)	6' 6" (1990)
TRACK SHOE WIDTH	N	ft.-in. (mm)	31.5" (800)	33.5" (850)
TRACK HEIGHT	O	ft.-in. (mm)	41.3" (1048)	41.3" (1048)
CAR BODY CLEARANCE	P	ft.-in. (mm)	20.1" (510)	20.1" (510)

* Not shown
 ** Without catwalk/with catwalks
 *** Retracted/extended

DX420LC-5

			STANDARD ARM (US20)	LONG ARM (US30)
BOOM TYPE		ft.-in. (mm)	22' (6700)	22' (6700)
ARM TYPE		ft.-in. (mm)	10'8" (3250)	13' (3950)
BUCKET TYPE (SAE)		yd ³ (m ³)	2.49 (1.9)	1.88 (1.44)
TRACK TYPE			FIXED	FIXED
SHIPPING LENGTH	A	ft.-in. (mm)	38' 6" (11 750)	38' 6" (11 760)
SHIPPING HEIGHT (BOOM)	B ₂	ft.-in. (mm)	10' 11" (3350)	11' 1" (3390)
SHIPPING HEIGHT (HOSE)	B ₁	ft.-in. (mm)	11' 4" (3455)	11' 5" (3495)
SHIPPING WIDTH	C	ft.-in. (mm)	11' 7" (3550)	11' 11" (3650)
COUNTERWEIGHT CLEARANCE	D	ft.-in. (mm)	4' 1" (1265)	4' 1" (1265)
TAIL SWING RADIUS	E ₁	ft.-in. (mm)	12' 4" (3760)	12' 4" (3760)
TAIL SWING OVERHAND (REAR)	E ₂	ft.-in. (mm)	45.6" (1160)	45.6" (1160)
TAIL SWING OVERHAND (SIDE)	E ₃ *	ft.-in. (mm)	6' 6" (1985)	6' 4" (1935)
CABIN HEIGHT	F	ft.-in. (mm)	10' 4" (3154)	10' 4" (3154)
UPPER STRUCTURE WIDTH	G	ft.-in. (mm)	9' 9" (2990)	9' 9" (2990)
CABIN HEIGHT ABOVE HOUSE	H	ft.-in. (mm)	33.3" (845)	33.3" (845)
CABIN WIDTH	I	ft.-in. (mm)	39.8" (1010)	39.8" (1010)
TUMBLER DISTANCE	J	ft.-in. (mm)	13' 10" (4230)	13' 10" (4230)
OVERALL TRACK LENGTH	K	ft.-in. (mm)	17' 0" (5200)	17' 0" (5200)
UNDERCARRIAGE WIDTH	L	ft.-in. (mm)	11' 7" (3550)	11' 11" (3650)
TRACK GAUGE WIDTH	M	ft.-in. (mm)	6' 6" (1990)	6' 6" (1990)
TRACK SHOE WIDTH	N	ft.-in. (mm)	31.5" (800)	35.4" (900)
TRACK HEIGHT	O	ft.-in. (mm)	41.3" (1050)	41.3" (1050)
CAR BODY CLEARANCE	P	ft.-in. (mm)	21.3" (540)	21.3" (540)

DX490LC-5

			STANDARD ARM (US20)	STANDARD ARM (US30)
BOOM TYPE		ft.-in. (mm)	23'4" (7100)	23'4" (7100)
ARM TYPE		ft.-in. (mm)	11' (3350)	11' (3350)
BUCKET TYPE (SAE)		yd ³ (m ³)	2.8 (2.14)	2.8 (2.14)
TRACK TYPE			VARIABLE	FIXED
SHIPPING LENGTH	A	ft.-in. (mm)	40' 1" (12 230)	40' 3" (12 280)
SHIPPING HEIGHT (BOOM)	B ₂	ft.-in. (mm)	11' 8" (3580)	11' 3" (3430)
SHIPPING HEIGHT (HOSE)	B ₁	ft.-in. (mm)	12' 1" (3705)	11' 7" (3555)
SHIPPING WIDTH	C	ft.-in. (mm)	10' 10" (3290)	12' 0" (3650)
COUNTERWEIGHT CLEARANCE	D	ft.-in. (mm)	4' 9" (1460)	4' 3" (1310)
TAIL SWING RADIUS	E ₁	ft.-in. (mm)	12' 5" (3800)	12' 5" (3800)
TAIL SWING OVERHAND (REAR)	E ₂	ft.-in. (mm)	42.2" (1073)	42" (1068)
TAIL SWING OVERHAND (SIDE)	E ₃ *	ft.-in. (mm)	7' / 6' 1" (2130/1850)	6' 11" (2125)
CABIN HEIGHT	F	ft.-in. (mm)	10' 11" (3350)	10' 5" (3200)
UPPER STRUCTURE WIDTH	G	ft.-in. (mm)	9' 9"/10' 10" (2990/3296)**	9' 9"/10' 10" (2990/3296)**
CABIN HEIGHT ABOVE HOUSE	H	ft.-in. (mm)	33.3" (845)	33.3" (845)
CABIN WIDTH	I	ft.-in. (mm)	39.8" (1010)	39.8" (1010)
TUMBLER DISTANCE	J	ft.-in. (mm)	14' 8" (4475)	14' 8" (4480)
OVERALL TRACK LENGTH	K	ft.-in. (mm)	17' 10" (5455)	17' 11" (5465)
UNDERCARRIAGE WIDTH	L	ft.-in. (mm)	10' 10"/12' 5" (3290/3790) ***	12' 0" (3650)
TRACK GAUGE WIDTH	M	ft.-in. (mm)	6' 6" (1990)	6' 6" (1990)
TRACK SHOE WIDTH	N	ft.-in. (mm)	35.4" (900)	35.4" (900)
TRACK HEIGHT	O	ft.-in. (mm)	47.6" (1210)	44.9" (1140)
CAR BODY CLEARANCE	P	ft.-in. (mm)	30' 3" (770)	22' 4" (570)

DX530LC-5

			MASS EXCAVATION ARM (US20)	LONG ARM (US30)	SUPER LONG REACH (US50)
BOOM TYPE		ft.-in. (mm)	23'4" (7100)	23'4" (7100)	36'1" (11 000)
ARM TYPE		ft.-in. (mm)	9' 6" (2900)	11' (3350)	26'3" (8000)
BUCKET TYPE (SAE)		yd ³ (m ³)	3.1 (2.39)	2.8 (2.14)	1.22 (0.92)
TRACK TYPE			WIDE VARIABLE	WIDE VARIABLE	WIDE VARIABLE
SHIPPING LENGTH	A	ft.-in. (mm)	40' 5" (12 330)	40' 1" (12 230)	53' 1" (16 195)
SHIPPING HEIGHT (BOOM)	B ₂	ft.-in. (mm)	12' 5" (3800)	11' 8" (3580)	12' 10" (3935)
SHIPPING HEIGHT (HOSE)	B ₁	ft.-in. (mm)	12' 9" (3895)	12' 1" (3705)	13' 4" (4070)
SHIPPING WIDTH	C	ft.-in. (mm)	11' 11" (3640)	11' 11" (3640)	11' 11" (3640)
COUNTERWEIGHT CLEARANCE	D	ft.-in. (mm)	4' 9" (1460)	4' 9" (1460)	4' 9" (1460)
TAIL SWING RADIUS	E ₁	ft.-in. (mm)	12' 5" (3800)	12' 5" (3800)	12' 5" (3800)
TAIL SWING OVERHAND (REAR)	E ₂	ft.-in. (mm)	42.2" (1073)	42.2" (1073)	42.2" (1073)
TAIL SWING OVERHAND (SIDE)	E ₃ *	ft.-in. (mm)	7' / 6' 1" (2130/1850)	7' / 6' 1" (2130/1850)	7' / 6' 1" (2130/1850)
CABIN HEIGHT	F	ft.-in. (mm)	10' 11" (3350)	10' 11" (3350)	10' 11" (3350)
UPPER STRUCTURE WIDTH	G	ft.-in. (mm)	9' 9"/10' 10" (2990/3296)**	9' 9"/10' 10" (2990/3296)**	9' 9"/10' 10" (2990/3296)**
CABIN HEIGHT ABOVE HOUSE	H	ft.-in. (mm)	33.3" (845)	33.3" (845)	33.3" (845)
CABIN WIDTH	I	ft.-in. (mm)	39.8" (1010)	39.8" (1010)	39.8" (1010)
TUMBLER DISTANCE	J	ft.-in. (mm)	14' 8" (4475)	14' 8" (4475)	14' 8" (4475)
OVERALL TRACK LENGTH	K	ft.-in. (mm)	17' 10" (5455)	17' 10" (5455)	17' 10" (5455)
UNDERCARRIAGE WIDTH	L	ft.-in. (mm)	11' 11"/13' 9" (3640/4200) ***	11' 11"/13' 9" (3640/4200)***	11' 11"/13' 9" (3640/4200)***
TRACK GAUGE WIDTH	M	ft.-in. (mm)	6' 6" (1990)	6' 6" (1990)	6' 6" (1990)
TRACK SHOE WIDTH	N	ft.-in. (mm)	35' 4" (900)	35' 4" (900)	35' 4" (900)
TRACK HEIGHT	O	ft.-in. (mm)	47.6" (1210)	47.6" (1210)	47.6" (1210)
CAR BODY CLEARANCE	P	ft.-in. (mm)	30' 3" (770)	30' 3" (770)	30' 3" (770)

Working Range

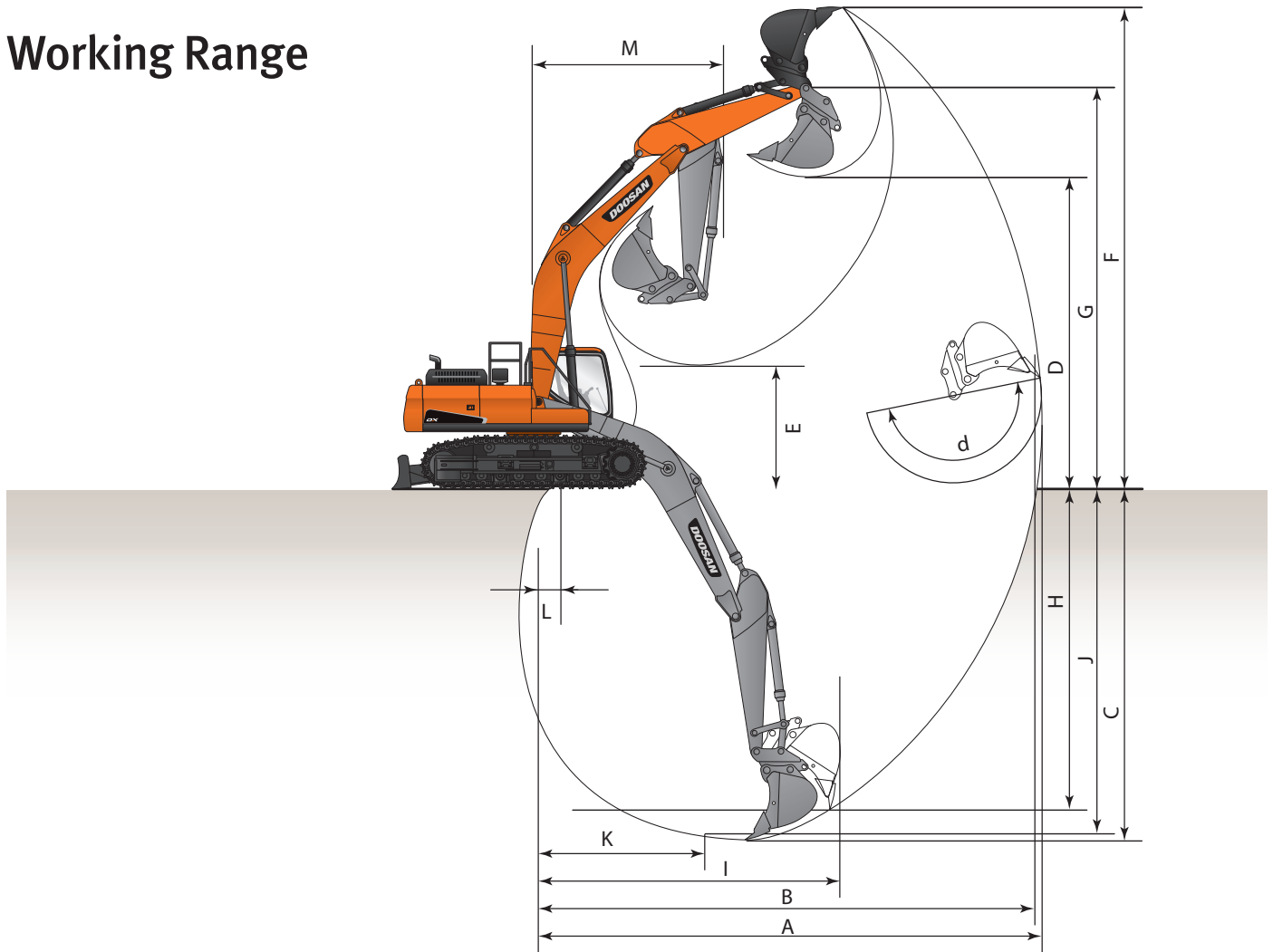

DX300LC-5

		STANDARD ARM (US20)	LONG ARM (US30)
BOOM TYPE	ft.-in. (mm)	21'4" (6500)	21'4" (6500)
ARM TYPE	ft.-in. (mm)	10'6" (3200)	13'0" (3950)
BUCKET TYPE (SAE) PCSA	yd ³ (m ³)	1.95 (1.49)	1.63 (1.25)
TRACK TYPE		FIXED	FIXED
MAX. DIGGING REACH	A ft.-in. (mm)	36' 7" (11 170)	39' 1" (11 930)
MAX. DIGGING REACH (GROUND)	B ft.-in. (mm)	35' 11" (10 970)	38' 6" (11 745)
MAX. DIGGING DEPTH	C ft.-in. (mm)	24' 8" (7535)	27' 2" (8290)
MAX. LOADING HEIGHT	D ft.-in. (mm)	23' 6" (7175)	25' 0" (7635)
MIN. LOADING HEIGHT	E ft.-in. (mm)	8' 10" (2710)	6' 4" (1955)
MAX. DIGGING HEIGHT	F ft.-in. (mm)	33' 10" (10 315)	35' 5" (10 815)
MAX. BUCKET PIN HEIGHT	G ft.-in. (mm)	29' 1" (8880)	30' 7" (9340)
MAX. VERTICAL WALL DEPTH	H ft.-in. (mm)	19' 3" (5890)	22' 4" (6830)
MAX. RADIUS VERTICAL	I ft.-in. (mm)	25' 3" (7720)	25' 6" (7785)
MAX. DEPTH TO 8' LINE	J ft.-in. (mm)	24' 1" (7345)	26' 9" (8155)
MIN. RADIUS 8' LINE	K ft.-in. (mm)	10' 10" (3320)	11' 1" (3395)
MIN. DIGGING REACH	L ft.-in. (mm)	28" (710)	-13.7" (-349)
MIN. SWING RADIUS	M ft.-in. (mm)	14' 7" (4455)	14' 10" (4515)
BUCKET ANGLE (DEG)	d Degrees	178°	178°

DX350LC-5

		STANDARD ARM (US20)	LONG ARM (US30)	SUPER LONG REACH (US50)
BOOM TYPE	ft.-in. (mm)	20'6" (6245)	20'6" (6245)	32'10" (10 000)
ARM TYPE	ft.-in. (mm)	10'2" (3100)	12'4" (3750)	23' (7000)
BUCKET TYPE (SAE) PCSA	yd ³ (m ³)	1.66 (1.27)	1.35 (1.03)	0.84 (0.64)
TRACK TYPE		FIXED	FIXED	FIXED
MAX. DIGGING REACH	A ft.-in. (mm)	35' 2" (10 725)	36' 10" (11 240)	57' 5" (17 510)
MAX. DIGGING REACH (GROUND)	B ft.-in. (mm)	34' 6" (10 530)	36' 3" (11 065)	57' 0" (17 390)
MAX. DIGGING DEPTH	C ft.-in. (mm)	23' 11" (7305)	26' 0" (7950)	45' 2" (13 780)
MAX. LOADING HEIGHT	D ft.-in. (mm)	23' 11" (7280)	24' 3" (7395)	39' 3" (11 975)
MIN. LOADING HEIGHT	E ft.-in. (mm)	9' 0" (2750)	6' 11" (2110)	8' 11" (2730)
MAX. DIGGING HEIGHT	F ft.-in. (mm)	33' 10" (10 325)	34' 1" (10 405)	46' 7" (14 195)
MAX. BUCKET PIN HEIGHT	G ft.-in. (mm)	29' 1" (8880)	29' 7" (8990)	43' 7" (13 290)
MAX. VERTICAL WALL DEPTH	H ft.-in. (mm)	20' 1" (6125)	21' 7" (6600)	38' 0" (11 590)
MAX. RADIUS VERTICAL	I ft.-in. (mm)	22' 5" (6840)	23' 2" (7070)	35' 9" (10 900)
MAX. DEPTH TO 8' LINE	J ft.-in. (mm)	23' 3" (7110)	25' 5" (7755)	43' 11" (13 395)
MIN. RADIUS 8' LINE	K ft.-in. (mm)	9' 10" (3000)	9' 6" (2920)	13' 6" (4140)
MIN. DIGGING REACH	L ft.-in. (mm)	24.4" (620)	-11" (-280)	45.7" (1160)
MIN. SWING RADIUS	M ft.-in. (mm)	13' 3" (4040)	13' 3" (4050)	20' 0" (6120)
BUCKET ANGLE (DEG)	d Degrees	175°	174°	169°

DX420LC-5

			STANDARD ARM (US20)	LONG ARM (US30)
BOOM TYPE		ft.-in. (mm)	22' (6700)	22' (6700)
ARM TYPE		ft.-in. (mm)	10' 8" (3250)	13' (3950)
BUCKET TYPE (SAE) PCSA		yd ³ (m ³)	2.49 (1.9)	1.88 (1.44)
TRACK TYPE			FIXED	FIXED
MAX. DIGGING REACH	A	ft.-in. (mm)	37' 8" (11 495)	39' 11" (12 180)
MAX. DIGGING REACH (GROUND)	B	ft.-in. (mm)	37' 0" (11 290)	39' 3" (11 980)
MAX. DIGGING DEPTH	C	ft.-in. (mm)	25' 4" (7740)	27' 8" (8435)
MAX. LOADING HEIGHT	D	ft.-in. (mm)	25' 3" (7710)	26' 6" (8100)
MIN. LOADING HEIGHT	E	ft.-in. (mm)	9' 9" (2995)	7' 6" (2300)
MAX. DIGGING HEIGHT	F	ft.-in. (mm)	35' 5" (10 820)	36' 10" (11 240)
MAX. BUCKET PIN HEIGHT	G	ft.-in. (mm)	30' 11" (9440)	32' 3" (9830)
MAX. VERTICAL WALL DEPTH	H	ft.-in. (mm)	14' 2" (4320)	16' 9" (5110)
MAX. RADIUS VERTICAL	I	ft.-in. (mm)	30' 11" (9440)	31' 9" (9700)
MAX. DEPTH TO 8' LINE	J	ft.-in. (mm)	24' 9" (7550)	27' 2" (8290)
MIN. RADIUS 8' LINE	K	ft.-in. (mm)	11' 2" (3420)	11' 4" (3475)
MIN. DIGGING REACH	L	ft.-in. (mm)	30.9" (785)	-8.9" (-225)
MIN. SWING RADIUS	M	ft.-in. (mm)	14' 8" (4475)	14' 11" (4555)
BUCKET ANGLE (DEG)	d	Degrees	183°	183.9°

DX490LC-5

			STANDARD ARM (US20)	STANDARD ARM (US30)
BOOM TYPE		ft.-in. (mm)	23'4" (7100)	23'4" (7100)
ARM TYPE		ft.-in. (mm)	11' (3350)	11' (3350)
BUCKET TYPE (SAE) PCSA		yd ³ (m ³)	2.8 (2.14)	2.8 (2.14)
TRACK TYPE			VARIABLE	FIXED
MAX. DIGGING REACH	A	ft.-in. (mm)	39' 9" (12 125)	39' 9" (12 125)
MAX. DIGGING REACH (GROUND)	B	ft.-in. (mm)	38' 11" (11 865)	39' 0" (11 895)
MAX. DIGGING DEPTH	C	ft.-in. (mm)	25' 6" (7790)	26' 0" (7940)
MAX. LOADING HEIGHT	D	ft.-in. (mm)	25' 9" (7865)	25' 3" (7715)
MIN. LOADING HEIGHT	E	ft.-in. (mm)	10' 3" (3130)	9' 9" (2980)
MAX. DIGGING HEIGHT	F	ft.-in. (mm)	36' 3" (11 050)	35' 9" (10 900)
MAX. BUCKET PIN HEIGHT	G	ft.-in. (mm)	31' 9" (9690)	31' 3" (9540)
MAX. VERTICAL WALL DEPTH	H	ft.-in. (mm)	14' 4" (4370)	14' 9" (4520)
MAX. RADIUS VERTICAL	I	ft.-in. (mm)	32' 8" (9970)	32' 8" (9970)
MAX. DEPTH TO 8' LINE	J	ft.-in. (mm)	25' 0" (7635)	25' 6" (7785)
MIN. RADIUS 8' LINE	K	ft.-in. (mm)	12' 9" (3895)	12' 9" (3895)
MIN. DIGGING REACH	L	ft.-in. (mm)	33.1" (840)	41.5" (1055)
MIN. SWING RADIUS	M	ft.-in. (mm)	17' 1" (5210)	17' 1" (5210)
BUCKET ANGLE (DEG)	d	Degrees	189.1°	189.1°

DX530LC-5

			MASS EXCAVATION ARM (US20)	LONG ARM (US30)	SUPER LONG REACH (US50)
BOOM TYPE		ft.-in. (mm)	23'4" (7100)	23'4" (7100)	36'1" (11 000)
ARM TYPE		ft.-in. (mm)	9' 6" (2900)	11' (3350)	26'3" (8000)
BUCKET TYPE (SAE) PCSA		yd ³ (m ³)	3.1 (2.39)	2.8 (2.14)	1.22 (0.92)
TRACK TYPE			WIDE VARIABLE	WIDE VARIABLE	WIDE VARIABLE
MAX. DIGGING REACH	A	ft.-in. (mm)	38' 5" (11 720)	39' 9" (12 125)	64' 4" (19 615)
MAX. DIGGING REACH (GROUND)	B	ft.-in. (mm)	37' 6" (11 455)	38' 11" (11 865)	63' 9" (19 455)
MAX. DIGGING DEPTH	C	ft.-in. (mm)	24' 0" (7340)	25' 6" (7790)	49' 7" (15 125)
MAX. LOADING HEIGHT	D	ft.-in. (mm)	25' 4" (7725)	25' 9" (7865)	39' 0" (11 890)
MIN. LOADING HEIGHT	E	ft.-in. (mm)	11' 8" (3580)	10' 3" (3130)	4' 9" (1465)
MAX. DIGGING HEIGHT	F	ft.-in. (mm)	35' 9" (10 920)	36' 3" (11 050)	47' 4" (14 435)
MAX. BUCKET PIN HEIGHT	G	ft.-in. (mm)	31' 3" (9550)	31' 9" (9690)	43' 9" (13 355)
MAX. VERTICAL WALL DEPTH	H	ft.-in. (mm)	13' 3" (4045)	14' 4" (4370)	42' 0" (12 805)
MAX. RADIUS VERTICAL	I	ft.-in. (mm)	31' 10" (9710)	32' 8" (9970)	39' 10" (12 165)
MAX. DEPTH TO 8' LINE	J	ft.-in. (mm)	23' 6" (7165)	25' 0" (7635)	49' 2" (15 010)
MIN. RADIUS 8' LINE	K	ft.-in. (mm)	12' 8" (3885)	12' 9" (3895)	20' 2" (6165)
MIN. DIGGING REACH	L	ft.-in. (mm)	6' 7" (2010)	30.1" (840)	1.6" (40)
MIN. SWING RADIUS	M	ft.-in. (mm)	17' 2" (5235)	17' 1" (5210)	25' 8" (7825)
BUCKET ANGLE (DEG)	d	Degrees	181.2°	189.1°	177.6°

Digging Force (ISO)

DX300LC-5

		STANDARD ARM (US20)	LONG ARM (US30)	SUPER LONG REACH (US50)
BUCKET (PCSA)	BUCKET SIZE (SAE) yd ³ (m ³)	1.66 (1.27) STD	1.35 (1.03)	0.84 (0.64) SLR
DIGGING FORCE	lbf.	44,092	44,092	23,149
	kgf	20 000	20 000	10 500
	kN	196	196	103
ARM	ARM SIZE ft.-in. (mm)	10'2" STD (3100)	12'4" (3750)	23' (7000)
DIGGING FORCE	lbf.	30,644	27,337	16,535
	kgf	13 900	12 400	7500
	kN	136	122	74

DX350LC-5

		STANDARD ARM (US20)	LONG ARM (US30)
BUCKET (PCSA)	BUCKET SIZE (SAE) yd ³ (m ³)	1.95 (1.49) STD	1.63 (1.25)
DIGGING FORCE	lbf.	57,100	57,100
	kgf	25 900	25 900
	kN	254	254
ARM	ARM SIZE ft.-in. (mm)	10' 6" (3200)	13' 0" (3950)
DIGGING FORCE	lbf.	41,667	35,274
	kgf	18 900	16 000
	kN	185	157

DX420LC-5

		STANDARD ARM (US20)	LONG ARM (US30)
BUCKET (PCSA)	BUCKET SIZE (SAE) yd ³ (m ³)	2.49 (1.90) STD	1.88 (1.44)
DIGGING FORCE	lbf.	59,745	59,745
	kgf	27 100	27 100
	kN	266	266
ARM	ARM SIZE ft.-in. (mm)	10' 8" (3250)	13' (3950)
DIGGING FORCE	lbf.	43,431	37,258
	kgf	19 700	16 900
	kN	193	166

DX490LC-5

		STANDARD ARM (US20 & US30)
BUCKET (PCSA)	BUCKET SIZE (SAE) yd ³ (m ³)	2.80 (2.14) STD
DIGGING FORCE	lbf.	67,902
	kgf	30 800
	kN	302
ARM	ARM SIZE ft.-in. (mm)	11' STD (3350)
DIGGING FORCE	lbf.	50,045
	kgf	22 700
	kN	223

DX530LC-5

		STANDARD ARM (US20)	LONG ARM (US30)	SUPER LONG REACH (US50)
BUCKET (PCSA)	BUCKET SIZE (SAE) yd ³ (m ³)	3.1 (2.39) STD	2.80 (2.14)	1.22 (0.92) SLR
DIGGING FORCE	lbf.	67,902	67,902	33,510
	kgf	30 800	30 800	15 200
	kN	302	302	149
ARM	ARM SIZE ft.-in. (mm)	9'6" STD. (2900)	11' (3350)	26'3" (8000)
DIGGING FORCE	lbf.	56,879	50,045	26,235
	kgf	25 800	22 700	11 900
	kN	253	223	117

Standard/Optional Equipment

- Standard Equipment
- Optional Equipment
- N/A

	DX300LC-5	DX350LC-5	DX420LC-5	DX490LC-5	DX530LC-5
ENGINE					
Emissions (EPA)	T4	T4	T4	T4	T4
High Pressure Common Rail (HPCR)	•	•	•	•	•
Variable Geometry (VGT)	•	•	•	•	•
Cooled Exhaust Gas Recirculation (CEGR)	•	•	•	•	•
Exhaust Brake	•	•	•	•	•
Diesel Oxidation Catalyst (DOC)	•	•	•	•	•
Selective Catalyst Reduction (SCR)	•	•	•	•	•
Diesel Exhaust Fluid (DEF)	•	•	•	•	•
Fuel Filter with Water Separator	•	•	•	•	•
Coolant Recovery Tank	•	•	•	•	•
Dual Element Dry-Type Air Filter with Evacuator	•	•	•	•	•
Pre Cleaner	•	•	•	•	•
Electronic Engine Control (ECU)	•	•	•	•	•
Auto-Idle	•	•	•	•	•
Auto-Shutdown (Time Adjustable)	•	•	•	•	•
Overheat & Low Oil Pressure Engine Protection	•	•	•	•	•
Block Heater (110V)	■	■	■	■	■
Diesel Powered Coolant Heater	■	■	■	■	■
Fuel Filler Pump	■	■	■	■	■
HYDRAULIC					
Electronic Power Optimizing System (EPOS)	•	•	•	•	•
Bent Axis Piston Main Pump (Tandem)	-	-	-	-	-
Variable Axial Piston Main Pump (Tandem)	•	•	•	•	•
Cross-Sensing Pump Control	•	•	•	•	•
Pilot-Operated Control Valves	•	•	•	•	•
Gear Pilot Pump	•	•	•	•	•
D-ECOPOWER	-	-	-	-	-
Smart Power Control (SPC)	•	•	•	•	•
Variable Speed Hydraulic Cooling Fan	•	•	•	•	•
Axial Piston Swing Motor	•	•	•	•	•
Spring-Applied Hydraulic Release Brake	•	•	•	•	•
Axial Piston Travel Motor (High/Low, Auto)	•	•	•	•	•
Auxiliary Hydraulics, One-Way	•	•	•	•	•
Auxiliary Hydraulics, Two-Way	■	■	■	■	■
Auxiliary Hydraulics, Rotate	■	■	■	■	■
Adjustable Auxiliary Flow & Pressure, 10 Presets	•	•	•	•	•
Intelligent Floating Boom	■	■	■	■	■
Boom Lock Valve	■	■	■	■	■
CABIN					
Steel, All-Weather & Sound Suppressed	•	•	•	•	•
ROPS (ISO 12117-2:2008)	•	•	•	•	•
Viscous Mount	•	•	•	•	•
Front Window with Wiper/Washer	•	•	•	•	•
Tinted Safety Glass	•	•	•	•	•
Skylight	•	•	•	•	•
Visor, Front Window & Skylight	•	•	•	•	•
Pull-Up Type Top Front Window	•	•	•	•	•
Removable Lower Front Window with Storage Behind Seat	•	•	•	•	•
Wiper (Lower Window)	■	■	■	■	■
Adjustable Sliding Side Door Windows	•	•	•	•	•
Defrost, Front Window	•	•	•	•	•
Lockable Doors	•	•	•	•	•
Seat	•	•	•	•	•
- Heated	•	•	•	•	•
- Air Suspension	•	•	•	•	•
- 2" (51 mm) Seat Belt	•	•	•	•	•
- Adjustable Height & Recline	•	•	•	•	•
- Adjustable Arm Rests	•	•	•	•	•
- Adjustable Fore/Aft	•	•	•	•	•
3" (76 mm) Seat Belt	■	■	■	■	■
Control Stands	•	•	•	•	•
- Height Adjustable	•	•	•	•	•
- Mounted to Seat Base	•	•	•	•	•
Storage for Operator's Manuals	•	•	•	•	•
Mirrors	•	•	•	•	•
Fully Automatic HVAC w/ Ambient Temperature Sensor	•	•	•	•	•
7" Multi-Function LCD	•	•	•	•	•
Cigarette Lighter	•	•	•	•	•
AM/FM Stereo with CD Player & MP3	•	•	•	•	•
Speakers (2)	•	•	•	•	•
Antenna, Roof-Mounted	•	•	•	•	•
Emergency Breakout Tool	•	•	•	•	•
Hot/Cold Beverage Compartment	•	•	•	•	•
Power Socket, 12V	•	•	•	•	•
Beverage Holder	•	•	•	•	•
Interior Light	•	•	•	•	•
Coat Hanger	•	•	•	•	•
Rain Shield	■	■	■	■	■
Guard, FOGS	■	■	■	■	■
Guard, Front Window Guard	■	■	■	■	■
Vandalism Window Covers	■	■	■	■	■
ELECTRICAL					
System Voltage - 24 V	•	•	•	•	•
Alternator - 24V, 100 Amp	•	•	•	•	•
2 x 12V Batteries, 200 AH Reserve Capacity	•	•	•	•	•

	DX300LC-5	DX350LC-5	DX420LC-5	DX490LC-5	DX530LC-5
ELECTRICAL - CONTINUED					
Blade Type Fuse Panel	•	•	•	•	•
Main Circuit Breaker	•	•	•	•	•
Light, Work (Halogen): Machine (2), Boom (2)	•	•	•	•	•
Light, Work (Halogen): Cabin (2)	■	■	■	■	■
Light, Work (Halogen): Cabin (4 Front, 2 Rear)	■	■	■	■	■
Rotating Beacon	■	■	■	■	■
Hour Meter	•	•	•	•	•
Engine Restart Prevention System	•	•	•	•	•
Rearview Camera	•	•	•	•	•
Side View Camera (Right Side)	■	■	■	■	■
Laptop Service Port	•	•	•	•	•
Self-Diagnostics System	•	•	•	•	•
Telematics	•	•	•	•	•
DISPLAY MONITOR & WARNINGS					
Buzzer	•	•	•	•	•
- Engine Oil Pressure	•	•	•	•	•
- Coolant Temperature	•	•	•	•	•
Gauges	•	•	•	•	•
- Fuel Level	•	•	•	•	•
- DEF Level	•	•	•	•	•
- Engine Coolant Temperature	•	•	•	•	•
- Hydraulic Oil Temperature	•	•	•	•	•
- Engine RPM	•	•	•	•	•
- Hydraulic Pump Pressure	•	•	•	•	•
Warning & Indicator Lights	•	•	•	•	•
- Seat Belt	•	•	•	•	•
- Hydraulic Return Filter	•	•	•	•	•
- SCR Warning	•	•	•	•	•
- Check Engine	•	•	•	•	•
- Engine Oil Pressure	•	•	•	•	•
- Engine Pre-Heat Engaged	•	•	•	•	•
- Hydraulic Oil Temperature	•	•	•	•	•
- Hydraulic Charge Pressure	•	•	•	•	•
- Radiator Coolant Level & Temperature	•	•	•	•	•
- Fuel Consumption	•	•	•	•	•
- Battery Voltage	•	•	•	•	•
- ECO	•	•	•	•	•
- Digital Clock	•	•	•	•	•
- Trip Meter	•	•	•	•	•
- Hour Meter	•	•	•	•	•
- Work Lights On	•	•	•	•	•
- Hydraulic Pilot Filter	•	•	•	•	•
- Battery Charge	•	•	•	•	•
- Water in Fuel	•	•	•	•	•
- Fuel Level	•	•	•	•	•
- Air Filter	•	•	•	•	•
- DEF Level - Low	•	•	•	•	•
- Error Code	•	•	•	•	•
Swing Alarm	•	•	•	•	•
Travel Alarm	•	•	•	•	•
UNDERCARRIAGE					
Fixed Track Width	•	•	•	•	•
Variable Track Width	-	-	-	-	-
Track Guards and Chains with Adjusters	•	•	•	•	•
Track Rollers, Upper (2 Each Side)	•	•	•	•	•
Track Rollers, Upper (3 Each Side)	-	-	-	-	-
Track Rollers, Lower (9 Each Side)	•	•	•	•	•
In-Shoe Motor Protection	•	•	•	•	•
Shoes, Triple Grouser - 700 mm	■	■	■	■	■
Shoes, Triple Grouser - 750 mm	-	-	■	■	■
Shoes, Triple Grouser - 800 mm	•	•	•	•	•
Shoes, Triple Grouser - 850 mm	■	■	■	■	■
Shoes, Triple Grouser - 900 mm	-	■	■	■	■
CONTROLS					
Joystick Controls	•	•	•	•	•
Pattern Control Change Valve (SAE, ISO)	•	•	•	•	•
Joystick Attachment Control Switches/Buttons	•	•	•	•	•
- One-way	•	•	•	•	•
- Two-way	•	•	•	•	•
- Power Boost	•	•	•	•	•
Foot Pedal Attachment Control	•	•	•	•	•
Control Stands	•	•	•	•	•
- Height Adjustable	•	•	•	•	•
- Sliding (Fore/Aft)	•	•	•	•	•
Engine Speed Control Dial	•	•	•	•	•
Travel Pedals with Hand Levers	•	•	•	•	•
Straight Travel Pedal	■	■	■	■	■
Switches, Console-Mounted	•	•	•	•	•
- Starter (Key)	•	•	•	•	•
- Travel Speed Selector	•	•	•	•	•
- Auxiliary Mode Switch	•	•	•	•	•
Emergency Stop Switch	•	•	•	•	•
Power Mode (P+, P, S, E)	•	•	•	•	•
Work Mode (Digging, Lifting, Breaker, Shear)	•	•	•	•	•
Smart Power Control (SPC)	•	•	•	•	•
Jog Dial Display Control	•	•	•	•	•
Wiper Control Panel	•	•	•	•	•
Audio Control Panel	•	•	•	•	•
OTHER					
Centralized Lubrication	•	•	•	•	•
- Boom	•	•	•	•	•
- Arm	•	•	•	•	•
- Swing Bearing	•	•	•	•	•
Handrails & Service Platforms	•	•	•	•	•
Skid-Resistant Steps & Service Platforms	•	•	•	•	•
Manuals	•	•	•	•	•
- Operations & Maintenance	•	•	•	•	•
- Parts	•	•	•	•	•
- AEM Safety Manual	•	•	•	•	•
Telematics, Three-Year Subscription	•	•	•	•	•
Vandalism Protection	•	•	•	•	•
- Lockable Panels	•	•	•	•	•
- Lockable Fluid Fill Points	•	•	•	•	•
- Anti-Theft Protection (Password)	•	•	•	•	•
Air Compressor	■	■	■	■	■

Standard Equipment based on Standard Arm (US20) configuration (DX300LC-5 - DX490LC-5)
 Standard Equipment based on Mass Excavation Arm (US20) configuration (DX530LC-5)

Lifting Capacity

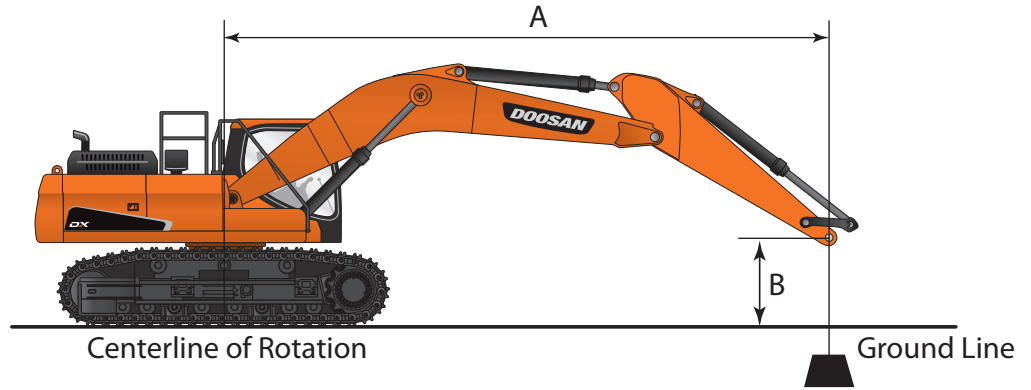

DX300LC-5 Standard Arm (US20) – Fixed Track

Track Width: 11' 1" (3400 MM)
 Boom: 20' 6" (6245 mm)
 Arm: 10' 2" (3100 mm)

Bucket: None
 Track Shoe Width: 31.5" (800 mm)
 Counterweight: 11,685 lb (5300 kg) Unit: 1,000 lb (1000 kg)

Feet

B ft \ A ft	5		10		15		20		25		MAX REACH		A ft		
25													* 12.01	* 12.01	23.53
20							* 15.01	* 15.01	* 14.95	13.31			* 11.50	* 11.50	26.74
15					* 20.53	* 20.53	* 17.35	* 17.35	* 15.88	13.00			* 11.50	10.34	28.72
10					* 27.16	26.55	* 20.50	17.42	* 17.46	12.53			* 11.91	9.57	29.73
5					* 32.78	24.79	* 23.56	16.53	* 19.14	12.06			* 12.76	9.29	29.88
0 (GROUND)					* 35.6	23.95	* 25.71	15.93	18.82	11.71			* 14.25	9.46	29.17
-5	* 19.16	** 19.16	* 27.69	* 27.69	* 36.00	23.74	26.05	15.67	18.66	11.56			16.30	10.20	27.53
-10	* 31.29	* 31.29	* 42.93	* 42.93	* 34.32	23.95	* 25.68	15.75					19.06	11.85	24.79
-15			* 41.43	* 41.43	* 29.80	24.59	* 21.68	16.28					* 20.86	15.79	20.49

Metric

B m \ A m	1.5		3		4.5		6		7.5		9		MAX REACH		A mm	
7.5														* 5.42	* 5.42	7.27
6.0							* 6.87	* 6.87	* 6.78	6.20				* 5.21	* 5.21	8.19
4.5					* 9.55	* 9.55	* 8.00	* 8.00	* 7.27	6.04				* 5.22	4.67	8.77
3.0					* 12.64	12.30	* 9.47	8.07	* 8.02	5.81	* 5.96	4.39		* 5.41	4.33	9.07
1.5					* 15.20	11.50	* 10.88	7.66	* 8.81	5.59	6.78	4.29		* 5.80	4.21	9.10
0 (GROUND)					* 16.45	11.12	* 11.87	7.39	8.74	5.43				* 6.46	4.29	8.89
-1.5	* 8.59	* 8.59	* 12.25	* 12.25	* 16.60	11.03	12.11	7.27	8.66	5.36				7.38	4.62	8.40
-3.0	* 13.97	* 13.97	* 18.94	* 18.94	* 15.84	11.13	* 11.88	7.30	8.73	5.42				8.59	5.34	7.59
-4.5			* 19.23	* 19.23	* 13.86	11.41	* 10.21	7.52						* 9.44	7.02	6.32



*Hydraulically Limited

- Load point is the end of the arm.
- Capacities marked with an asterisk (*) are limited by hydraulic capacities.
- Lift capacities shown do not exceed 75% of minimum tipping loads or 87% of hydraulic capacities.
- The least stable position is over the side.
- The total mass of machine includes the mass of the boom, arm, counterweight, all operating fluids and 165 lb (75 kg) operator.
- Lift capacities are in compliance with ISO 10567.















DX300LC-5 Long Arm (US30) – Fixed Track

Track Width: 11' 3" (3400 MM)
 Boom: 20' 6" (6245 mm)
 Arm: 12' 4" (3750 mm)















Bucket: None
 Track Shoe Width: 33.5" (850 mm)
 Counterweight: 13,890 lb (6300 kg) Unit: 1,000 lb (1000 kg)

 Load Radius Over
 Front Load Radius Over Side

Feet

B ft \ A ft	5		10		15		20		25		30		MAX REACH		A ft
															
25									* 11.38	* 11.38			* 9.92	* 9.92	25.69
20									* 13.21	* 13.21			* 9.61	* 9.61	28.65
15							* 15.39	* 15.39	* 14.38	14.27	* 11.2	10.59	* 9.67	* 9.67	30.50
10					* 23.97	* 23.97	* 18.67	* 18.67	* 16.13	13.73	* 14.44	10.36	* 10.04	9.58	31.46
5					* 30.27	27.36	* 22.03	18.12	* 18.03	13.18	15.69	10.08	* 10.78	9.31	31.60
0 (GROUND)			* 19.37	* 19.37	* 34.24	26.13	* 24.65	17.37	* 19.64	12.74	15.45	9.86	* 11.99	9.44	30.93
-5	* 18.97	* 18.97	* 27.60	* 27.60	* 35.71	25.66	* 26.06	16.96	19.89	12.48			* 14.03	10.05	29.39
-10	* 28.12	* 28.12	* 38.81	* 38.81	* 35.06	25.68	* 26.00	16.91	19.89	12.48			* 17.77	11.40	26.84
-15	* 39.41	* 39.41	* 45.71	* 45.71	* 31.97	26.14	* 23.76	17.20					* 19.82	14.34	22.94
-20			* 34.59	* 34.59	* 24.30	* 24.30							* 21.25	* 21.25	16.75

Metric

B m \ A m	1.5		3		4.5		6		7.5		9		MAX REACH		A mm
															
7.5									* 5.63	* 5.63			* 4.48	* 4.48	7.92
6.0									* 6.00	* 6.00			* 4.36	* 4.36	8.78
4.5							* 7.09	* 7.09	* 6.58	* 6.58	* 5.68	4.93	* 4.39	* 4.39	9.32
3.0					* 11.15	* 11.15	* 8.62	* 8.62	* 7.41	6.37	* 6.80	4.81	* 4.56	4.34	9.59
1.5					* 14.04	12.69	* 10.17	8.40	* 8.30	6.11	* 7.27	4.68	* 4.89	4.22	9.63
0 (GROUND)			* 8.55	* 8.55	* 15.83	12.13	* 11.37	8.05	* 9.04	5.91	7.17	4.57	* 5.44	4.28	9.43
-1.5	* 8.52	* 8.52	* 12.24	* 12.24	* 16.48	11.92	* 12.02	7.87	9.24	5.79			* 6.34	4.55	8.97
-3.0	* 12.58	* 12.58	* 17.17	* 17.17	* 16.18	11.93	* 12.01	7.84	9.23	5.78			* 7.99	5.14	8.21
-4.5	* 17.53	* 17.53	* 21.18	* 21.18	* 14.82	12.13	* 11.06	7.97					* 8.96	6.42	7.05
-6.0			* 16.32	* 16.32	* 11.55	* 11.55							* 9.6	* 9.60	5.24

*Hydraulically Limited



- Load point is the end of the arm.
- Capacities marked with an asterisk (*) are limited by hydraulic capacities.
- Lift capacities shown do not exceed 75% of minimum tipping loads or 87% of hydraulic capacities.
- The least stable position is over the side.
- The total mass of machine includes the mass of the boom, arm, counterweight, all operating fluids and 165 lb (75 kg) operator.
- Lift capacities are in compliance with ISO 10567.

Lifting Capacity











DX300LC-5 Super Long Reach (US50) – Fixed Track

Track Width: 11' 3" (3400 MM)
 Boom: 32' 10" (10 000 mm)
 Arm: 23' 0" (7000 mm)











Bucket: None
 Track Shoe Width: 33.5" (850 mm)
 Counterweight: 13,890 lb (6300 kg) Unit: 1,000 lb (1000 kg)

 Load Radius Over
 Front Load Radius Over Side

Feet

A ft \ B ft		5		10		15		20		25	
											
40											
35											
30											
25											
20											
15											
10						* 19.86	* 19.86	* 14.00	* 14.00	* 11.13	* 11.13
5						* 14.96	* 14.96	* 16.97	15.57	* 13.00	11.68
0 (GROUND)				* 7.39	* 7.39	* 13.12	* 13.12	* 19.29	14.08	* 14.63	10.66
-5	* 8.55	* 8.55	* 9.75	* 9.75	* 14.05	* 14.05	* 20.82	13.19	* 15.88	9.94	
-10	* 10.74	* 10.74	* 12.17	* 12.17	* 15.99	* 15.99	* 21.68	12.76	16.73	9.50	
-15	* 13.04	* 13.04	* 14.73	* 14.73	* 18.53	* 18.53	* 21.99	12.62	16.51	9.30	
-20	* 15.49	* 15.49	* 17.53	* 17.53	* 21.61	19.65	* 21.81	12.72	16.49	9.28	
-25	* 18.15	* 18.15	* 20.66	* 20.66	* 25.36	20.18	* 21.12	13.00	16.67	9.44	
-30	* 21.11	* 21.11	* 24.29	* 24.29	* 25.65	20.95	* 19.8	13.47	* 15.95	9.77	
-35			* 28.66	* 28.66	* 22.50	22.01	* 17.59	14.18	* 14.23	10.32	
-40					* 17.58	* 17.58	* 13.85	* 13.85	* 10.89	* 10.89	













Metric













A mm \ B m		1.5		3		4.5		6		7.5	
											
12.0											
10.5											
9.0											
7.5											
6.0											
4.5											
3.0						* 9.29	* 9.29	* 6.51	* 6.51	* 5.16	* 5.16
1.5						* 6.47	* 6.47	* 7.87	7.19	* 6.02	5.40
0 (GROUND)			* 3.30	* 3.30	* 5.78	* 5.78	* 8.93	6.51	* 6.76	4.93	
-1.5	* 3.87	* 3.87	* 4.37	* 4.37	* 6.23	* 6.23	* 9.62	6.11	* 7.34	4.60	
-3.0	* 4.84	* 4.84	* 5.45	* 5.45	* 7.11	* 7.11	* 10.01	5.92	* 7.72	4.40	
-4.5	* 5.86	* 5.86	* 6.59	* 6.59	* 8.23	* 8.23	* 10.15	5.86	7.66	4.31	
-6.0	* 6.95	* 6.95	* 7.83	* 7.83	* 9.59	9.13	* 10.07	5.90	7.65	4.30	
-7.5	* 8.12	* 8.12	* 9.20	* 9.20	* 11.22	9.37	* 9.76	6.02	7.73	4.37	
-9.0	* 9.43	* 9.43	* 10.79	* 10.79	* 11.91	9.71	* 9.19	6.23	* 7.41	4.51	
-10.5			* 12.69	* 12.69	* 10.53	10.18	* 8.23	6.54	* 6.67	4.75	
-12.0					* 8.42	* 8.42	* 6.65	* 6.65	* 5.30	5.14	

*Hydraulically Limited

- Load point is the end of the arm.
- Capacities marked with an asterisk (*) are limited by hydraulic capacities.
- Lift capacities shown do not exceed 75% of minimum tipping loads or 87% of hydraulic capacities.
- The least stable position is over the side.
- The total mass of machine includes the mass of the boom, arm, counterweight, all operating fluids and 165 lb (75 kg) operator.
- Lift capacities are in compliance with ISO 10567.

Feet

30		35		40		45		50		MAX REACH		A ft
												
				* 4.39	* 4.39					* 3.21	* 3.21	41.69
						* 3.28	* 3.28			* 3.07	* 3.07	45.23
				* 5.82	* 5.82	* 5.19	* 5.19			* 3.00	* 3.00	48.05
				* 6.10	* 6.10	* 6.11	5.78	* 3.15	* 3.15	* 2.98	* 2.98	50.18
				* 6.52	* 6.52	* 6.38	5.59	* 4.64	4.44	* 3.00	* 3.00	51.74
* 8.21	* 8.21	* 7.53	* 7.53	* 7.07	6.67	* 6.75	5.36	* 5.65	4.31	* 3.06	* 3.06	52.79
* 9.46	* 9.46	* 8.4	7.83	* 7.68	6.28	* 7.19	5.09	* 6.41	4.14	* 3.16	* 3.16	53.34
* 10.73	9.11	* 9.28	7.27	* 8.32	5.90	* 7.65	4.83	6.77	3.97	* 3.31	* 3.31	53.42
* 11.88	8.40	* 10.12	6.77	* 8.93	5.55	7.78	4.58	6.60	3.81	* 3.52	3.41	53.02
* 12.85	7.85	10.83	6.37	8.98	5.26	7.57	4.38	6.47	3.69	* 3.79	3.43	52.15
12.99	7.49	10.52	6.09	8.75	5.04	7.42	4.24	* 5.46	3.61	* 4.17	3.53	50.77
12.78	7.29	10.35	5.92	8.63	4.93	7.35	4.18			* 4.69	3.74	48.82
12.73	7.24	10.3	5.88	8.61	4.91	7.39	4.21			* 5.44	4.08	46.24
12.83	7.34	10.39	5.97	8.73	5.02					* 6.61	4.63	42.95
13.12	7.60	10.66	6.22							* 8.64	5.52	38.74
* 11.6	8.09									* 10.02	7.15	33.24
										* 10.49	* 10.49	25.64



9		10.5		12		13.5		15		MAX REACH		A mm
												
										* 1.45	* 1.45	12.85
						* 1.86	* 1.86			* 1.39	* 1.39	13.90
						* 2.56	* 2.56			* 1.36	* 1.36	14.71
				* 2.78	* 2.78	* 2.78	2.70	* 1.82	* 1.82	* 1.35	* 1.35	15.33
				* 2.99	* 2.99	* 2.91	2.61	* 2.40	2.09	* 1.36	* 1.36	15.79
* 3.79	* 3.79	* 3.46	* 3.46	* 3.24	3.11	* 3.09	2.50	* 2.82	2.02	* 1.39	* 1.39	16.1
* 4.37	* 4.37	* 3.87	3.63	* 3.53	2.92	* 3.29	2.38	* 3.14	1.94	* 1.44	* 1.44	16.26
* 4.95	4.22	* 4.28	3.37	* 3.82	2.74	* 3.51	2.25	3.15	1.86	* 1.5	* 1.50	16.28
* 5.48	3.89	* 4.67	3.14	* 4.11	2.58	3.62	2.14	3.07	1.78	* 1.60	1.55	16.16
* 5.93	3.64	* 5.00	2.96	4.17	2.44	3.52	2.04	3.01	1.72	* 1.72	1.56	15.9
6.03	3.47	4.88	2.82	4.06	2.34	3.44	1.97	2.97	1.68	* 1.89	1.60	15.49
5.93	3.38	4.8	2.75	4.00	2.29	3.41	1.94			* 2.12	1.69	14.91
5.90	3.35	4.77	2.72	3.99	2.27	3.42	1.95			* 2.44	1.84	14.16
5.95	3.4	4.81	2.76	4.03	2.32					* 2.95	2.07	13.18
6.07	3.51	4.92	2.86							* 3.80	2.46	11.94
* 5.47	3.71									* 4.52	3.13	10.35
										* 4.74	4.61	8.16

*Hydraulically Limited















- Load point is the end of the arm.
- Capacities marked with an asterisk (*) are limited by hydraulic capacities.
- Lift capacities shown do not exceed 75% of minimum tipping loads or 87% of hydraulic capacities.
- The least stable position is over the side.
- The total mass of machine includes the mass of the boom, arm, counterweight, all operating fluids and 165 lb (75 kg) operator.
 - Lift capacities are in compliance with ISO 10567.

Lifting Capacity















DX350LC-5 Standard Arm (US20) – Fixed Track

Track Width: 11' 5" (3480 mm)	Bucket: None	 Load Radius Over  Front Load Radius Over Side
Boom: 21' 4" (6500 mm)	Track Shoe Width: 31.5" (800 mm)	
Arm: 10' 6" (3200 mm)	Counterweight: 15,653 lb (7100 kg)	

Feet

B ft \ A ft	5		10		15		20		25		30		MAX REACH		A ft
															
25									* 17.47	17.02			* 17.22	16.94	25.06
20									* 17.95	16.92			* 16.73	13.86	28.07
15					* 27.02	* 27.02	* 21.84	* 21.84	* 19.21	16.41			* 16.87	12.21	29.95
10					* 34.39	33.24	* 25.32	21.85	* 20.98	15.75	17.8	11.9	16.99	11.35	30.89
5					* 39.8	31.03	* 28.39	20.69	* 22.68	15.11	17.47	11.6	16.63	11.04	31
0 (GROUND)					* 41.64	30.09	* 30.2	19.94	22.45	14.66	17.25	11.39	17.02	11.25	30.28
-5			* 33.9	* 33.9	* 40.81	29.92	* 30.38	19.64	22.23	14.46			18.35	12.08	28.66
-10	* 39.93	* 39.93	* 51.68	* 51.68	* 37.74	30.23	* 28.62	19.75	* 21.96	14.6			* 20.65	13.92	25.98
-15			* 42.23	* 42.23	* 31.66	31.03	* 23.73	20.34					* 20.76	18.11	21.84



Metric

B m \ A m	1.5		3		4.5		6		7.5		9		MAX REACH		A mm
															
7.5									* 8.07	7.95			* 7.78	7.53	7.73
6									* 8.19	7.87			* 7.58	6.22	8.6
4.5					* 12.58	* 12.58	* 10.08	* 10.08	* 8.82	7.62	* 8.2	5.67	* 7.66	5.51	9.15
3					* 16	15.39	* 11.71	10.12	* 9.66	7.3	8.27	5.53	7.7	5.14	9.42
1.5					* 18.44	14.39	* 13.12	9.59	* 10.45	7.01	8.11	5.38	7.54	5.01	9.45
0 (GROUND)					* 19.22	13.98	* 13.94	9.25	10.42	6.8	8	5.28	7.72	5.1	9.23
-1.5			* 15	* 15	* 18.81	13.91	* 14.02	9.11	10.32	6.7			8.31	5.47	8.75
-3	* 17.84	* 17.84	* 23.42	* 23.42	* 17.42	14.05	* 13.24	9.16	* 10.23	6.76			* 9.36	6.28	7.96
-4.5			* 19.6	* 19.6	* 14.73	14.41	* 11.14	9.41					* 9.43	8.08	6.73















*Hydraulically Limited

- Load point is the end of the arm.
- Capacities marked with an asterisk (*) are limited by hydraulic capacities.
- Lift capacities shown do not exceed 75% of minimum tipping loads or 87% of hydraulic capacities.
- The least stable position is over the side.
- The total mass of machine includes the mass of the boom, arm, counterweight, all operating fluids and 165 lb (75 kg) operator.
 - Lift capacities are in compliance with ISO 10567.















DX350LC-5 Long Arm (US30) – Fixed Track

Track Width: 11' 6" (3530 mm)	Bucket: None	 Load Radius Over  Front Load Radius Over Side
Boom: 21' 4" (6500 mm)	Track Shoe Width: 33.5" (850 mm)	
Arm: 13' (3950 mm)	Counterweight: 15,653 lb (7100 kg) Unit: 1,000 lb (1000 kg)	

Feet

B ft \ A ft	5		10		15		20		25		30		MAX REACH		A ft	
																
30														* 14.65	* 14.65	24.29
25									* 15.41	* 15.41				* 13.50	* 13.50	28.31
20									* 15.94	* 15.94	* 15.86	12.61		* 13.04	11.86	30.98
15							* 19.36	* 19.36	* 17.41	16.72	* 16.35	12.38		* 13.01	10.62	32.69
10					* 30.33	* 30.33	* 23.04	22.34	* 19.39	15.96	* 17.32	12.00		* 13.35	9.95	33.56
5					* 36.92	31.74	* 26.58	20.97	* 21.39	15.21	17.52	11.59		* 14.08	9.69	33.66
0(GROUND)					* 40.46	30.19	* 29.08	19.98	22.46	14.61	17.16	11.26		14.94	9.82	33.00
-5	* 20.26	* 20.26	* 29.78	* 29.78	* 41.08	29.62	* 30.08	19.46	22.08	14.26	16.99	11.10		15.87	10.40	31.53
-10	* 31.95	* 31.95	* 43.58	* 43.58	* 39.32	29.68	* 29.35	19.37	22.02	14.22				17.83	11.67	29.12
-15	* 46.18	* 46.18	* 48.77	* 48.77	* 34.93	30.23	* 26.3	19.7	* 19.48	14.6				* 18.68	14.27	25.49
-20			* 35.68	* 35.68	* 26.20	* 26.20	* 18.11	* 18.11						* 18.00	* 18.00	20.05

Metric



B m \ A m	1.5		3		4.5		6		7.5		9		MAX REACH		A mm	
																
9									* 6.75	* 6.75				* 6.58	* 6.58	7.54
7.5														* 6.10	* 6.10	8.71
6.0									* 7.28	* 7.28	* 7.18	5.89		* 5.91	5.33	9.48
4.5									* 7.99	7.76	* 7.46	5.76		* 5.91	4.80	9.98
3.0					* 14.11	* 14.11	* 10.65	10.35	* 8.92	7.40	* 7.94	5.58		* 6.07	4.50	10.23
1.5					* 17.11	14.72	* 12.28	9.72	* 9.86	7.05	8.14	5.38		* 6.39	4.39	10.26
0(GROUND)					* 18.70	14.02	* 13.43	9.27	10.43	6.78	7.97	5.23		6.78	4.45	10.06
-1.5	* 9.08	* 9.08	* 13.19	* 13.19	* 18.96	13.77	* 13.88	9.03	10.25	6.61	7.88	5.15		7.19	4.71	9.62
-3.0	* 14.27	* 14.27	* 19.27	* 19.27	* 18.16	13.80	* 13.57	8.98	10.22	6.59				8.05	5.27	8.90
-4.5	* 20.53	* 20.53	* 22.61	* 22.61	* 16.20	14.04	* 12.24	9.13	* 9.21	6.74				* 8.47	6.39	7.84
-6.0			* 16.84	* 16.84	* 12.41	* 12.41	* 8.86	* 8.86						* 8.21	* 8.21	6.23

*Hydraulically Limited















- Load point is the end of the arm.
- Capacities marked with an asterisk (*) are limited by hydraulic capacities.
- Lift capacities shown do not exceed 75% of minimum tipping loads or 87% of hydraulic capacities.
- The least stable position is over the side.
- The total mass of machine includes the mass of the boom, arm, counterweight, all operating fluids and 165 lb (75 kg) operator.
- Lift capacities are in compliance with ISO 10567.

Lifting Capacity















DX420LC-5 Standard Arm (US20) – Fixed Track

Track Width: 11' 7" (3550 mm)	Bucket: None	31.5" (800 mm)	 Load Radius Over
Boom: 22' 0" (6700 mm)	Track Shoe Width:	Unit: 1,000 lb (1000 kg)	 Front Load Radius Over Side
Arm: 10' 8" (3250 mm)	Counterweight: 17,637 lb (8000 kg)		

Feet

B ft \ A ft	5		10		15		20		25		30		MAX REACH		A ft	
																
30														* 20.95	* 20.95	22.20
25									* 21.46	20.81				* 19.38	18.74	26.50
20									* 22.02	20.51				* 18.88	15.64	29.30
15					* 34.8	* 34.80	* 27.48	* 27.48	* 23.79	19.81	* 21.87	14.78		* 19.05	13.93	31.05
10					* 43.95	39.85	* 31.82	26.26	* 26.04	18.97	22.09	14.39		* 19.80	13.03	31.91
5					* 45.20	37.36	* 35.44	24.88	* 28.09	18.20	21.65	13.99		19.68	12.73	31.97
0 (GROUND)					* 48.13	36.42	* 37.38	24.03	27.87	17.65	21.35	13.72		20.17	12.99	31.22
-5			* 33.08	* 33.08	* 49.87	36.31	* 37.32	23.71	27.61	17.42				21.72	13.93	29.60
-10	* 40.31	* 40.31	* 52.29	* 52.29	* 45.84	36.71	* 35.01	23.85	* 27.13	17.56				* 24.15	15.98	26.95
-15			* 50.58	* 50.58	* 38.44	37.64	* 29.28	24.51						* 23.99	20.46	22.91



Metric

B m \ A m	1.5		3		4.5		6		7.5		9		MAX REACH		A mm	
																
9.0														* 9.40	* 9.40	6.92
7.5									* 9.72	9.70				* 8.76	8.36	8.15
6.0									* 10.08	9.53				* 8.56	7.03	8.97
4.5					* 16.22	* 16.22	* 12.70	* 12.70	* 10.94	9.19	* 9.99	6.88		* 8.65	6.29	9.48
3.0					* 20.47	18.45	* 14.72	12.17	* 12.00	8.8	10.26	6.68		* 9.00	5.90	9.73
1.5					* 18.92	17.33	* 16.39	11.53	* 12.95	8.44	10.06	6.49		8.93	5.77	9.74
0 (GROUND)					* 20.73	16.92	* 17.26	11.14	12.94	8.18	9.91	6.36		9.15	5.89	9.52
-1.5			* 14.64	* 14.64	* 22.98	16.89	* 17.22	11.00	12.82	8.07	9.88	6.34		9.83	6.31	9.03
-3.0	* 18.01	* 18.01	* 23.12	* 23.12	* 21.15	17.07	* 16.19	11.06	* 12.62	8.13				* 10.95	7.21	8.24
-4.5			* 23.47	* 23.47	* 17.87	17.48	* 13.70	11.35						* 10.90	9.13	7.06
-6.0														* 10.50	* 10.50	4.93















*Hydraulically Limited

- Load point is the end of the arm.
- Capacities marked with an asterisk (*) are limited by hydraulic capacities.
- Lift capacities shown do not exceed 75% of minimum tipping loads or 87% of hydraulic capacities.
- The least stable position is over the side.
- The total mass of machine includes the mass of the boom, arm, counterweight, all operating fluids and 165 lb (75 kg) operator.
 - Lift capacities are in compliance with ISO 10567.















DX420LC-5 Long Arm (US30) – Fixed Track

Track Width: 11' 11" (3650 mm)	Bucket: None		
Boom: 22' 0" (6700 mm)	Track Shoe Width: 35.4" (900 mm)		
Arm: 13' (3950 mm)	Counterweight: 21,605 lb (9800 kg)	Unit: 1,000 lb (1000 kg)	 Load Radius Over  Front Load Radius Over Side

Feet

B ft	A ft	5		10		15		20		25		30		MAX REACH		A ft
																
30										* 16.82	* 16.82			* 16.08	* 16.08	25.25
25										* 18.90	* 18.90			* 15.03	* 15.03	29.07
20										* 19.84	* 19.84	* 19.34	17.23	* 14.67	* 14.67	31.65
15								* 24.7	* 24.7	* 21.81	* 21.81	* 20.15	16.88	* 14.76	14.17	33.27
10						* 39.37	* 39.37	* 29.29	* 29.29	* 24.29	21.57	* 21.43	16.38	* 15.26	13.37	34.08
5						* 46.93	42.81	* 33.48	28.34	* 26.69	20.67	* 22.73	15.87	* 16.22	13.08	34.13
0 (GROUND)				* 20.40	* 20.40	* 50.43	41.18	* 36.24	27.22	* 28.44	19.97	* 23.62	15.48	* 17.78	13.29	33.43
-5	* 22.91	* 22.91	* 31.75	* 31.75	* 50.49	40.66	* 37.11	26.66	* 29.06	19.57	23.45	15.28	* 20.31	14.08	31.93	
-10	* 34.79	* 34.79	* 45.77	* 45.77	* 47.83	40.80	* 35.91	26.59	* 28.05	19.53			* 22.28	15.76	29.49	
-15	* 48.88	* 48.88	* 58.14	* 58.14	* 42.18	41.50	* 32.02	27.00	* 24.08	19.96			* 22.58	19.14	25.87	
-20			* 42.33	* 42.33	* 31.63	* 31.63	* 22.62	* 22.62					* 21.76	* 21.76	20.43	

Metric

B m	A m	1.5		3		4.5		6		7.5		9		MAX REACH		A mm
																
9.0										* 8.52	* 8.52			* 7.23	* 7.23	7.83
7.5										* 8.58	* 8.58			* 6.80	* 6.80	8.94
6.0										* 9.08	* 9.08	* 8.79	7.18	* 6.65	8.27	9.69
4.5								* 11.41	* 11.41	* 10.02	9.39	* 9.22	7.00	* 6.70	5.67	10.16
3.0						* 18.32	* 18.32	* 13.55	12.48	* 11.19	8.95	* 9.84	6.76	* 6.93	5.34	10.39
1.5						* 21.76	17.76	* 15.48	11.73	* 12.31	8.53	10.14	6.52	* 7.37	5.22	10.40
0 (GROUND)				* 9.01	* 9.01	* 22.48	17.03	* 16.73	11.22	13.03	8.20	9.93	6.33	* 8.07	5.33	10.19
-1.5	* 10.28	* 10.28	* 14.09	* 14.09	* 23.29	16.80	* 17.13	10.96	12.82	8.02	9.82	6.24	8.79	6.51	9.74	
-3.0	* 15.56	* 15.56	* 20.28	* 20.28	* 22.08	16.87	* 16.60	10.93	12.79	7.99	9.88	9.28	9.85	6.27	9.02	
-4.5	* 21.76	* 21.76	* 26.94	* 26.94	* 19.56	17.18	* 14.89	11.11	* 11.34	8.17			* 10.24	7.60	7.94	
-6.0			* 19.97	* 19.97	* 14.96	* 14.96	* 10.96	* 10.96					* 9.93	* 9.93	6.35	

*Hydraulically Limited

- Load point is the end of the arm.
- Capacities marked with an asterisk (*) are limited by hydraulic capacities.
- Lift capacities shown do not exceed 75% of minimum tipping loads or 87% of hydraulic capacities.
- The least stable position is over the side.
- The total mass of machine includes the mass of the boom, arm, counterweight, all operating fluids and 165 lb (75 kg) operator.
 - Lift capacities are in compliance with ISO 10567.



Lifting Capacity

DX490LC-5 Standard Arm (US20) – Variable Track













Track Width: 12' 5" (3790 mm)
 Boom: 23'4" (7100 mm)
 Arm: 11' (3350 mm)

Bucket: None
 Track Shoe Width:
 Counterweight: 20,283 lb (9200 kg)













35.4" (900 mm)
 Unit: 1,000 lb (1000 kg)

 Load Radius Over
 Front Load Radius Over Side

Feet

B ft \ A ft	10		15		20		25		30		MAX REACH		A ft
													
30							* 21.85	* 21.85			* 18.9	* 18.9	25.55
25							* 23.89	* 23.89			* 17.83	* 17.83	29.17
20							* 25.33	25.14	* 23.72	18.61	* 17.52	16.96	31.59
15			* 43.93	* 43.93	* 33.04	* 33.04	* 27.71	24.14	* 24.73	18.16	* 17.74	15.42	33.07
10			* 53.81	48.09	* 37.91	31.80	* 30.35	23.06	* 26.08	17.59	* 18.46	14.63	33.73
5			* 40.18	* 40.18	* 41.53	30.23	* 32.56	22.13	26.68	17.07	* 19.76	14.42	33.64
0 (GROUND)			* 49.21	45.06	* 43.11	29.36	* 33.77	21.51	26.29	16.71	* 21.85	14.8	32.78
-5	* 38.72	* 38.72	* 56.15	45.14	* 42.56	29.10	* 33.53	21.27	26.21	16.64	24.98	15.91	31.08
-10	* 59.45	* 59.45	* 51.25	45.71	* 39.69	29.32	* 31.17	21.44			* 25.78	18.18	28.41
-15	* 54.87	* 54.87	* 42.87	* 42.87	* 33.4	30.09					* 25.23	22.94	24.42



Metric

B m \ A m	3		4.5		6		7.5		9		MAX REACH		A mm
													
9.0							* 10.90	* 10.90			* 8.50	* 8.50	7.92
7.5							* 10.90	* 10.90			* 8.07	* 8.07	8.96
6.0							* 11.64	* 11.64	* 10.82	8.66	* 7.95	7.64	9.66
4.5			* 20.53	* 20.53	* 15.31	* 15.31	* 12.77	11.2	* 11.34	8.44	* 8.06	6.97	10.09
3.0			* 21.54	* 21.54	* 17.56	14.73	* 14.00	10.69	* 11.99	8.16	* 8.39	6.63	10.28
1.5			* 16.99	* 16.99	* 19.20	14.01	* 15.03	10.26	12.39	7.92	* 8.97	6.54	10.25
0 (GROUND)			* 21.35	20.96	* 19.90	13.62	* 15.58	9.97	12.20	7.75	* 9.91	6.71	9.99
-1.5	* 17.20	* 17.20	* 25.85	21.01	* 19.63	13.51	* 15.48	9.86	12.15	7.71	11.31	7.20	9.49
-3.0	* 26.36	* 26.36	* 23.63	21.27	* 18.35	13.61	* 14.47	9.93			* 11.69	8.21	8.69
-4.5	* 25.43	* 25.43	* 19.91	* 19.91	* 15.59	13.94	* 11.53	10.28			* 11.47	10.26	7.51













*Hydraulically Limited

- Load point is the end of the arm.
- Capacities marked with an asterisk (*) are limited by hydraulic capacities.
- Lift capacities shown do not exceed 75% of minimum tipping loads or 87% of hydraulic capacities.
- The least stable position is over the side.
- The total mass of machine includes the mass of the boom, arm, counterweight, all operating fluids and 165 lb (75 kg) operator.
 - Lift capacities are in compliance with ISO 10567.













DX490LC-5 Standard Arm (US30) – Fixed Track

Track Width: 12' 0" (3650 mm)	Bucket: None	35.4" (900 mm)	 Load Radius Over  Front Load Radius Over Side
Boom: 23'4" (7100 mm)	Track Shoe Width:	Unit: 1,000 lb (1000 kg)	
Arm: 11' (3350 mm)	Counterweight: 20,283 lb (9200 kg)		

Feet

B ft \ A ft	10		15		20		25		30		MAX REACH		A ft
													
30							* 21.85	* 21.85			* 18.90	* 18.90	25.55
25							* 23.89	* 23.89			* 17.83	* 17.83	29.17
20							* 25.33	24.51	* 23.72	18.10	* 17.52	16.49	31.59
15			* 43.93	* 43.93	* 33.04	33.01	* 27.71	23.51	* 24.73	17.65	* 17.74	14.97	33.07
10			* 53.81	46.81	* 37.91	30.95	* 30.35	22.42	* 26.08	17.08	* 18.46	14.19	33.73
5			* 40.18	* 40.18	* 41.53	29.38	* 32.56	21.49	25.88	16.56	* 19.76	13.98	33.64
0 (GROUND)			* 49.21	43.78	* 43.11	28.52	33.36	20.88	25.50	16.21	* 21.85	14.34	32.78
-5	* 38.72	* 38.72	* 56.15	43.86	* 42.56	28.25	33.09	20.63	25.42	16.13	24.22	15.42	31.08
-10	* 59.45	* 59.45	* 51.25	44.43	* 39.69	28.48	* 31.17	20.80			* 25.78	17.64	28.41
-15	* 54.87	* 54.87	* 42.87	* 42.87	* 33.4	29.24					* 25.23	22.29	24.42

Metric

B m \ A m	3		4.5		6		7.5		9		MAX REACH		A mm
													
9.0							* 10.90	* 10.90			* 8.50	* 8.50	7.92
7.5							* 10.90	* 10.90			* 8.07	* 8.07	8.96
6.0							* 11.64	11.38	* 10.82	8.43	* 7.95	7.43	9.66
4.5			* 20.53	* 20.53	* 15.31	15.29	* 12.77	10.90	* 11.34	8.20	* 8.06	6.77	10.09
3.0			* 21.54	* 21.54	* 17.56	14.33	* 14.00	10.39	* 11.99	7.93	* 8.39	6.43	10.28
1.5			* 16.99	* 16.99	* 19.20	13.62	* 15.03	9.96	12.02	7.68	* 8.97	6.34	10.25
0 (GROUND)			* 21.35	20.37	* 19.90	13.23	15.50	9.68	11.84	7.52	* 9.91	6.51	9.99
-1.5	* 17.2	* 17.2	* 25.85	20.42	* 19.63	13.11	15.37	9.57	11.79	7.47	10.97	6.98	9.49
-3.0	* 26.36	* 26.36	* 23.63	20.68	* 18.35	13.21	* 14.47	9.64			* 11.69	7.96	8.69
-4.5	* 25.43	* 25.43	* 19.91	* 19.91	* 15.59	13.55	* 11.53	9.99			* 11.47	9.97	7.51

*Hydraulically Limited



- Load point is the end of the arm.
- Capacities marked with an asterisk (*) are limited by hydraulic capacities.
- Lift capacities shown do not exceed 75% of minimum tipping loads or 87% of hydraulic capacities.
- The least stable position is over the side.
- The total mass of machine includes the mass of the boom, arm, counterweight, all operating fluids and 165 lb (75 kg) operator.
- Lift capacities are in compliance with ISO 10567.

Lifting Capacity













DX530LC-5 Standard Arm (US20) – Wide Variable Track

Track Width: 13' 9" (4200 mm)
 Boom: 23'4" (7100 mm)
 Arm: 9'6" (2900 mm)













Bucket: None
 Track Shoe Width: 35.4" (900 mm)
 Counterweight: 24,471 lb (11 100 kg) Unit: 1,000 lb (1000 kg)

 Load Radius Over
 Front Load Radius Over Side

Feet

B ft \ A ft	10		15		20		25		30		MAX REACH		A ft	
														
30												* 25.86	* 25.86	23.79
25							* 25.49	* 25.49				* 24.25	* 24.25	27.64
20					* 30.28	* 30.28	* 26.72	* 26.72	* 25.11	23.12		* 23.77	22.88	30.17
15					* 34.85	* 34.85	* 28.95	* 28.95	* 25.78	22.77		* 24.06	20.83	31.72
10					* 39.46	* 39.46	* 31.40	29.03	* 26.91	22.27		* 25.06	19.82	32.41
5					* 42.55	38.65	* 33.33	28.18	* 27.82	21.82		* 25.88	19.64	32.32
0 (GROUND)			* 44.07	* 44.07	* 43.48	37.96	* 34.15	27.67	* 27.94	21.55		* 26.35	20.26	31.42
-5	* 37.12	* 37.12	* 54.67	* 54.67	* 42.24	37.85	* 33.37	27.54				* 26.73	21.95	29.65
-10	* 61.17	* 61.17	* 48.99	* 48.99	* 38.54	38.23	* 30.04	27.87				* 26.73	25.45	26.82
-15	* 48.21	* 48.21	* 39.37	* 39.37	* 30.66	* 30.66						* 25.45	* 25.45	22.54



Metric

B m \ A m	3		4.5		6		7.5		9		MAX REACH		A mm	
														
9.0												* 11.63	* 11.63	7.38
7.5							* 11.62	* 11.62				* 10.97	* 10.97	8.50
6.0					* 13.99	* 13.99	* 12.27	* 12.27	* 11.42	10.77		* 10.78	10.30	9.23
4.5					* 16.15	* 16.15	* 13.34	* 13.34	* 11.82	10.58		* 10.93	9.42	9.68
3.0					* 18.28	* 18.28	* 14.49	13.46	* 12.37	10.33		* 11.38	8.98	9.88
1.5					* 19.67	17.93	* 15.38	13.07	* 12.82	10.12		* 11.74	8.91	9.85
0 (GROUND)			* 18.94	* 18.94	* 20.06	17.62	* 15.76	12.83	* 12.91	9.99		* 11.95	9.19	9.58
-1.5			* 25.13	* 25.13	* 19.48	17.58	* 15.42	12.77	* 12.24	10.01		* 12.12	9.94	9.05
-3.0	* 28.04	* 28.04	* 22.58	* 22.58	* 17.83	17.75	* 13.99	12.90				* 12.13	11.47	8.21
-4.5	* 22.36	* 22.36	* 18.32	* 18.32	* 14.41	* 14.41						* 11.60	* 11.60	6.95













*Hydraulically Limited

- Load point is the end of the arm.
- Capacities marked with an asterisk (*) are limited by hydraulic capacities.
- Lift capacities shown do not exceed 75% of minimum tipping loads or 87% of hydraulic capacities.
- The least stable position is over the side.
- The total mass of machine includes the mass of the boom, arm, counterweight, all operating fluids and 165 lb (75 kg) operator.
 - Lift capacities are in compliance with ISO 10567.













DX530LC-5 Long Arm (US30) – Wide Variable Track

Track Width: 13' 9" (4200 mm)	Bucket: None	Track Shoe Width: 35.4" (900 mm)	 Load Radius Over
Boom: 23'4" (7100 mm)	Counterweight: 24,471 lb (11 100 kg)	Unit: 1,000 lb (1000 kg)	 Front Load Radius Over Side
Arm: 11' (3350mm)			

Feet

B ft \ A ft	10		15		20		25		30		MAX REACH		A ft
													
30							* 21.84	* 21.84			* 18.88	* 18.88	25.55
25							* 23.89	* 23.89			* 17.82	* 17.82	29.17
20							* 25.34	* 25.34	* 23.73	23.33	* 17.51	* 17.51	31.59
15			* 43.95	* 43.95	* 33.06	* 33.06	* 27.72	* 27.72	* 24.74	22.87	* 17.73	* 17.73	33.07
10			* 53.82	* 53.82	* 37.93	* 37.93	* 30.36	29.14	* 26.09	22.29	* 18.45	* 18.45	33.73
5			* 40.20	* 40.20	* 41.56	38.75	* 32.58	28.19	* 27.27	21.76	* 19.75	18.45	33.64
0 (GROUND)			* 49.22	* 49.22	* 43.14	37.86	* 33.79	27.56	* 27.78	21.40	* 21.84	18.96	32.78
-5	* 38.74	* 38.74	* 56.20	* 56.20	* 42.59	37.58	* 33.55	27.31	* 26.97	21.32	* 25.29	20.38	31.08
-10	* 59.46	* 59.46	* 51.29	* 51.29	* 39.72	37.81	* 31.19	27.48			* 25.79	23.23	28.41
-15	* 54.93	* 54.93	* 42.91	* 42.91	* 33.42	* 33.42					* 25.25	* 25.25	24.42

Metric

B m \ A m	3		4.5		6		7.5		9		MAX REACH		A mm
													
9.0							* 10.90	* 10.90			* 8.50	* 8.50	7.92
7.5							* 10.90	* 10.90			* 8.06	* 8.06	8.96
6.0							* 11.64	* 11.64	* 10.83	* 10.83	* 7.94	* 7.94	9.66
4.5			* 20.54	* 20.54	* 15.32	* 15.32	* 12.78	* 12.78	* 11.35	10.62	* 8.05	* 8.05	10.09
3.0			* 21.55	* 21.55	* 17.57	* 17.57	* 14.01	13.51	* 12.00	10.34	* 8.38	* 8.38	10.28
1.5			* 17.00	* 17.00	* 19.22	17.98	* 15.04	13.07	* 12.56	10.09	* 8.97	8.37	10.25
0 (GROUND)			* 21.36	* 21.36	* 19.91	17.58	* 15.59	12.78	* 12.82	9.92	* 9.91	8.60	9.99
-1.5	* 17.21	* 17.21	* 25.87	* 25.87	* 19.65	17.45	* 15.49	12.67	* 12.51	9.88	* 11.44	9.23	9.49
-3.0	* 26.37	* 26.37	* 23.65	* 23.65	* 18.36	17.56	* 14.48	12.74			* 11.7	10.49	8.69
-4.5	* 25.46	* 25.46	* 19.92	* 19.92	* 15.60	* 15.6	* 11.54	* 11.54			* 11.48	* 11.48	7.51

*Hydraulically Limited

- Load point is the end of the arm.
- Capacities marked with an asterisk (*) are limited by hydraulic capacities.
- Lift capacities shown do not exceed 75% of minimum tipping loads or 87% of hydraulic capacities.
- The least stable position is over the side.
- The total mass of machine includes the mass of the boom, arm, counterweight, all operating fluids and 165 lb (75 kg) operator.
 - Lift capacities are in compliance with ISO 10567.

Specifications



Lifting Capacity

DX530LC-5 Super Long Reach (US50) – Wide Variable Track













Track Width: 13' 9" (4200 mm)
 Boom: 36'1" (11 000 mm)
 Arm: 26'3" (8000 mm)

Bucket: None
 Track Shoe Width: 35.4" (900 mm)
 Counterweight: 24,471 lb (11 100 kg)













Unit: 1,000 lb (1000 kg)

 Load Radius Over
 Front Load Radius Over Side

Feet

B ft \ A ft		5		10		15		20		25		30	
													
40													
35													
30													
25													
20													
15													
10						* 29.56	* 29.56	* 25.96	* 25.96	* 20.06	* 20.06	* 16.6	* 16.6
5						* 19.06	* 19.06	* 30.25	* 30.25	* 22.86	* 22.86	* 18.51	* 18.51
0 (GROUND)				* 11.75	* 11.75	* 18.52	* 18.52	* 32.76	32.18	* 25.13	23.93	* 20.18	18.78
-5		* 13.60	* 13.60	* 15.17	* 15.17	* 20.46	* 20.46	* 31.28	30.74	* 26.74	22.70	* 21.49	17.82
-10		* 16.80	* 16.80	* 18.64	* 18.64	* 23.42	* 23.42	* 32.81	30.04	* 27.72	21.96	* 22.39	17.17
-15		* 20.13	* 20.13	* 22.29	* 22.29	* 27.03	* 27.03	* 35.89	29.82	* 28.10	21.59	* 22.86	16.79
-20		* 23.63	* 23.63	* 26.21	* 26.21	* 31.24	* 31.24	* 35.22	29.95	* 27.91	21.53	* 22.87	16.66
-25		* 27.41	* 27.41	* 30.52	* 30.52	* 36.15	* 36.15	* 33.84	30.36	* 27.12	21.72	* 22.38	16.75
-30		* 31.55	* 31.55	* 35.38	* 35.38	* 40.81	* 40.81	* 31.66	31.04	* 25.63	22.16	* 21.28	17.05
-35		* 36.18	* 36.18	* 41.04	* 41.04	* 36.10	* 36.10	* 28.44	* 28.44	* 23.24	22.85	* 19.35	17.60
-40				* 39.38	* 39.38	* 29.57	* 29.57	* 23.73	* 23.73	* 19.51	* 19.51	* 16.06	* 16.06













Metric















B m \ A m		1.5		3		4.5		6		7.5		9	
													
12													
10.5													
9													
7.5													
6													
4.5													
3						* 12.39	* 12.39	* 12.08	* 12.08	* 9.30	* 9.30	* 7.68	* 7.68
1.5						* 8.32	* 8.32	* 14.04	* 14.04	* 10.59	* 10.59	* 8.56	* 8.56
0 (GROUND)				* 5.27	* 5.27	* 8.20	* 8.20	* 14.28	* 14.28	* 11.62	11.08	* 9.33	8.70
-1.5		* 6.15	* 6.15	* 6.81	* 6.81	* 9.1	* 9.10	* 13.76	* 13.76	* 12.36	10.52	* 9.92	8.26
-3		* 7.57	* 7.57	* 8.36	* 8.36	* 10.44	* 10.44	* 14.49	13.95	* 12.80	10.19	* 10.34	7.96
-4.5		* 9.05	* 9.05	* 9.99	* 9.99	* 12.04	* 12.04	* 15.9	13.85	* 12.97	10.02	* 10.55	7.79
-6		* 10.61	* 10.61	* 11.72	* 11.72	* 13.90	* 13.90	* 16.26	13.91	* 12.89	9.99	* 10.57	7.73
-7.5		* 12.28	* 12.28	* 13.63	* 13.63	* 16.05	* 16.05	* 15.65	14.09	* 12.54	10.07	* 10.36	7.76
-9		* 14.11	* 14.11	* 15.76	* 15.76	* 18.6	* 18.6	* 14.69	14.40	* 11.89	10.26	* 9.88	7.89
-10.5		* 16.14	* 16.14	* 18.22	* 18.22	* 16.86	* 16.86	* 13.27	* 13.27	* 10.85	10.57	* 9.05	8.13
-12				* 18.75	* 18.75	* 14.01	* 14.01	* 11.23	* 11.23	* 9.25	* 9.25	* 7.66	* 7.66
-13.5										* 6.65	* 6.65		

*Hydraulically Limited

- Load point is the end of the arm.
- Capacities marked with an asterisk (*) are limited by hydraulic capacities.
- Lift capacities shown do not exceed 75% of minimum tipping loads or 87% of hydraulic capacities.
- The least stable position is over the side.
- The total mass of machine includes the mass of the boom, arm, counterweight, all operating fluids and 165 lb (75 kg) operator.
 - Lift capacities are in compliance with ISO 10567.

Feet

35		40		45		50		55		MAX REACH			
												A ft	
						* 6.23	* 6.23				* 6.05	* 6.05	50.19
						* 8.81	* 8.81				* 5.93	* 5.93	53.05
						* 9.10	* 9.10	* 6.29	* 6.29		* 5.88	* 5.88	55.31
						* 9.39	* 9.39	* 8.36	* 8.36		* 5.90	* 5.90	57.05
				* 10.23	* 10.23	* 9.79	* 9.79	* 9.50	8.58		* 6.00	* 6.00	58.32
		* 11.78	* 11.78	* 10.91	* 10.91	* 10.28	10.02	* 9.82	8.34		* 6.15	* 6.15	59.12
* 14.34	* 14.34	* 12.78	* 12.78	* 11.65	11.55	* 10.81	9.63	* 10.19	8.07		* 6.37	* 6.37	59.49
* 15.71	* 15.71	* 13.78	13.23	* 12.39	11.01	* 11.35	9.24	* 10.57	7.81		* 6.68	* 6.68	59.44
* 16.94	15.21	* 14.7	12.56	* 13.08	10.52	* 11.86	8.89	10.80	7.56		* 7.08	6.68	58.96
* 17.97	14.47	* 15.49	12.01	* 13.67	10.11	12.25	8.59	10.60	7.37		* 7.61	6.74	58.04
* 18.72	13.94	* 16.09	11.59	13.99	9.79	12.02	8.37	10.47	7.24		* 8.30	6.92	56.66
* 19.16	13.61	16.23	11.32	13.78	9.60	11.90	8.25				* 9.23	7.25	54.79
* 19.23	13.47	16.11	11.21	13.71	9.53	11.90	8.25				* 10.50	7.78	52.37
* 18.88	13.52	* 16.16	11.26	13.80	9.62						* 12.13	8.57	49.33
* 17.95	13.76	* 15.25	11.50	* 12.81	9.91						* 12.54	9.79	45.51
* 16.19	14.25	* 13.36	12.01								* 12.90	11.75	40.77
											* 13.07	* 13.07	34.61

10.5		12		13.5		15		16.5		18	18	MAX REACH			
														A ft	
						* 3.37	* 3.37						* 2.74	* 2.74	15.41
						* 4.07	* 4.07						* 2.68	* 2.68	16.25
						* 4.14	* 4.14	* 3.41	* 3.41				* 2.67	* 2.67	16.92
						* 4.29	* 4.29	* 4.20	4.11				* 2.68	* 2.68	17.43
				* 4.69	* 4.69	* 4.48	* 4.48	* 4.33	4.02				* 2.72	* 2.72	17.79
		* 5.42	* 5.42	* 5.01	* 5.01	* 4.71	4.67	* 4.49	3.90	* 2.86	* 2.86		* 2.79	* 2.79	18.03
* 6.62	* 6.62	* 5.89	* 5.89	* 5.36	* 5.36	* 4.96	4.49	* 4.67	3.77	* 3.24	3.17		* 2.9	* 2.9	18.13
* 7.25	* 7.25	* 6.35	6.14	* 5.70	5.12	* 5.22	4.31	* 4.85	3.64	* 3.35	3.09		* 3.03	* 3.03	18.11
* 7.82	7.05	* 6.78	5.83	* 6.02	4.89	* 5.46	4.14	* 5.02	3.53				* 3.21	3.03	17.97
* 8.29	6.71	* 7.14	5.57	* 6.3	4.7	* 5.66	4.00	4.93	3.43				* 3.45	3.06	17.7
* 8.64	6.47	* 7.42	5.38	6.49	4.55	5.58	3.89	4.86	3.37				* 3.75	3.14	17.29
* 8.84	6.31	7.53	5.25	6.39	4.45	5.52	3.83	4.84	3.34				* 4.16	3.28	16.73
* 8.89	6.25	7.47	5.20	6.36	4.42	5.51	3.82						* 4.72	3.51	16.02
* 8.74	6.26	7.49	5.21	6.39	4.45	* 5.56	3.89						* 5.49	3.85	15.11
* 8.35	6.36	* 7.11	5.31	* 6.03	4.57								* 5.67	4.37	14.00
* 7.61	6.57	* 6.35	5.52										* 5.84	5.21	12.6
* 6.24	* 6.24												* 5.93	* 5.93	10.82
													* 5.75	* 5.75	8.39

*Hydraulically Limited

- Load point is the end of the arm.
- Capacities marked with an asterisk (*) are limited by hydraulic capacities.
- Lift capacities shown do not exceed 75% of minimum tipping loads or 87% of hydraulic capacities.
- The least stable position is over the side.
- The total mass of machine includes the mass of the boom, arm, counterweight, all operating fluids and 165 lb (75 kg) operator.
 - Lift capacities are in compliance with ISO 10567.



DOOSAN STRONG



1.877.745.7814
DoosanEquipment.com/HEX

Printed on 10% recycled paper

Doosan and the Doosan logo are registered trademarks of Doosan Corp. in the United States and various other countries around the world. ©2015 Doosan Infracore Construction Equipment America. All rights reserved.

DOOSAN