

 **PUMA**





WALKAROUND.....	04 - 05
CAB.....	06 - 07
CONTROLS.....	08 - 09
ENGINE.....	10 - 11
SEMI- / FULL-POWERSHIFT TRANSMISSION	12 - 13
CVX TRANSMISSION.....	14 - 15
PTO.....	16 - 17

HYDRAULICS	18 - 19
DRIVELINE	20 - 21
ABS – ANTI-LOCK BRAKING SYSTEM	22 - 23
ADVANCED FARMING SYSTEMS.....	24 - 27
SERVICE	28 - 29
SYSTEM SOLUTIONS	30 - 31
SPECIFICATIONS	32 - 34



EFFICIENT POWER FOR PROFITABLE FARMING

At Case IH, we're proud of our successful history, but we're also focused firmly on the future. Through the brands that make up our heritage, we have supported farming for generations, providing robust, reliable, high productive and efficient farm equipment, engineered with precision and passion by a team that knows agriculture inside out.

Our commitment will never change, but farming's needs are constantly evolving, so while those characteristics remain at the core of Case IH products, our research and development team never rests on its laurels. That's why Puma tractors, well-established in the market with a reputation for efficiency, ease of operation and premium engineering, have undergone one of the most significant updates of their lifespan. It's nothing less than you'd expect from the name behind innovations whose introductions have helped move farming forwards. Developments such as Axial-Flow® single-rotor threshing and separation, Quadtrac articulated rubber track tractor technology, and CVX, which led the way in bringing continuously-variable transmissions to the tractor sector.

PUMA: EASY TO OPERATE MORE EFFICIENTLY.

Puma has a well-established reputation for a premium product in terms of tractor quality. Built in Austria around proven semi powershift, full powershift or CVX continuously-variable transmissions, and the latest FPT engine technology, Puma retains the high standards set by its predecessors. With seven models from 150-240 hp (rated), the Puma series sits squarely in territory that means it suits the most demanding applications in both arable, contracting and livestock farming situations.

Furthermore, as with all Case IH developments, it takes its class forward in multiple areas – transmission, suspension, controls, seating, lighting and more. What you get as a result is the reassurance of a proven product with enhancements aimed at giving your business a sharper edge, repaying your investment quicker than ever before.

MODELS	Rated power ECE R120 ³⁾ @ 2,200 rpm (kW/hp(CV))	Maximum power ECE R120 ³⁾ Power Management (kW/hp(CV))	Max. pump flow rate Standard / Optional (l/min)	Max. lift capacity (kg)	Wheelbase (mm)
Puma 150, Puma 150 CVX	110 / 150	140 / 190 @ 1,800-1,900 rpm	110 / -, 140 / 160	8,257	2,734
Puma 165, Puma 165 CVX	121 / 165	155 / 210 @ 1,800-1,900 rpm	110 / -, 140 / 160	8,257	2,734
Puma 175 CVX	132 / 180	166 / 225 @ 1,800-1,900 rpm	140 / 160	8,257	2,734
Puma 185, Puma 185 CVX	132 / 180	166 / 225 @ 1,800-1,900 rpm	120 / 150, 150 / 170	10,463	2,884
Puma 200, Puma 200 CVX	147 / 200	180 / 245 @ 1,800-1,900 rpm	120 / 150, 150 / 170	10,463	2,884
Puma 220, Puma 220 CVX	162 / 220	192 / 260 @ 1,800-1,900 rpm	120 / 150, 150 / 170	10,463	2,884
Puma 240 CVX	177 / 240	199 / 270 @ 1,800-1,900 rpm	150 / 170	10,463	2,884

³⁾ECE R120 correspond to ISO 14396 and 97 / 68 / EC or 2000 / 25 / EC

TOP TECHNOLOGY FOR THOSE WHO DEMAND MORE

FEATURES THAT BRING BENEFITS

A new machinery purchase is never a simple decision unless the machine in question is going to bring about a prompt return on investment. Case IH has always recognised this, and that's evident in the improvements made to the latest Puma. These are enhancements designed to give you more where you need it – more comfort, greater fuel efficiency, extra lighting, additional tyre options, better vision. Things that, ultimately, will show up in your bottom line, through higher workrates, faster job completion and lower diesel bills.



TRAVEL IN TOTAL COMFORT.

A range of seat options for Puma tractors means operators benefit from the best ride in the industry. The Puma and Puma CVX models boast an extremely comfortable, quiet and ergonomically designed cab with excellent allround-visibility. This operating concept is tailored to the needs and wishes of our clients in the most effective way possible, for minimum familiarization time and maximum work results!



INTUITIVE OPERATION PUTS YOU IN CONTROL.

The Multicontroller™ armrest, ICP operator's panel and AFS Pro 700™ touchscreen monitor combines all the key tractor functions. From selecting the ground speed or the industry leading Headland Management Control II, to operating the front and rear hitch – with the Multicontroller™ armrest, you have everything under complete control.

ADVANTAGES

- Top driving comfort and intuitive operation
- Latest lighting technology makes it easier to work at night
- Headland Management Control II to reduce operator fatigue
- Puma CVX supports latest ISOBUS Class III technology





POWER AND EFFICIENCY.

The powerful 6.7 litre, 6-cylinder engine is designed to generate power and optimize fuel efficiency. Stage IV emissions standards are achieved with our proprietary high efficiency Hi-eSCR only after-treatment system. The engine power management on Puma CVX models is now also available when operating in reverse, benefiting users who regularly use their tractors for reverse-drive applications such as mowing and snow blowing.



SEMI OR FULL POWERSHIFT, OR CVX TRANSMISSION - THE CHOICE IS YOURS.

The Puma 150-165 models are fitted with six-speed Semi-Powershift transmissions or optionally with Full Powershift transmissions, while the Puma 185-220 models are fitted with Full Powershift transmissions as standard and a continuously variable transmission is used in all Puma CVX models. The Active Stop control reliably prevents the tractor from rolling back on slopes and allows you to start the tractor easily without engaging the clutch or brake. The DKT™ double-clutch technology ensures smooth travel and a high level of fuel efficiency.



HIGH PERFORMANCE HYDRAULICS.

With an oil delivery rate of up to 150 l/min. (Puma) and 170 l/min. (Puma CVX), the hydraulics on these tractors are designed for heavy-duty work and a maximum hitch capacity of 10,463 kg in the rear hydraulics. Seven (models 150-175) or nine (from models 185) control valves can be connected. The front hitch and optional front power take-off (PTO), will increase your productivity even further.



COMFORT, CONTROL AND SAFETY.

The suspended front axle (optional) ensures smooth travel and improved operating comfort. If you frequently travel on roads, the ABS system, which is also available as an option, provides a clear benefit when it comes to safety – a benefit only offered by one series tractor in this class: the Case IH Puma.



PRECISE CONTROL.

With the Case IH AFS systems, you can maximize your efficiency, operate ISOBUS Class III-compatible devices from the cab and choose from a full range of guidance solutions, offering accuracy levels of up to 2.5 cm. The AFS Pro 700™ monitor, which can be integrated as an option, allows you to maintain control at all times – for example the HMC II (Headland Management Control II), which means that you have a state-of-the-art end of row system.



- A** LEFT-HAND CAB STORAGE AREA
- B** INSTRUCTIONAL SEAT
- C** LUXURY CARPETED FLOOR
REDUCES NOISE LEVELS FROM
TRANSMISSION/DRIVETRAIN
- D** HEATED AND VENTILATED
SEAT WITH EXTENDABLE/
RETRACTABLE LOWER
SEAT CUSHION
- E** AFS PRO 700 TOUCH SCREEN
- F** MULTICONTROLLER ARMREST
- G** AUTO CLIMATE CONTROL



Supreme comfort offered by an industry-exclusive high back Dual Motion low frequency seat in either fabric or leather.



24/7 efficiency in any conditions.

A COMFORTABLE ENVIRONMENT QUIET AND CALM FOR LONG DAYS

Climb up into a Puma and take a seat. It quickly becomes apparent that this is a comfortable environment. One that's made from the very best materials. One that's been designed by engineers who've researched what a tractor operator needs, and where controls are best placed for effortless operation. The semi-active heated and ventilated leather seat with adjustable cushion gives you the luxurious ride you would only expect from a high value saloon car. The automatic seat suspension reacts to the individual driver's weight to provide an optimally smooth ride on a rough drive.

A WORKPLACE WITH A FEEL-GOOD ATMOSPHERE.

The latest Puma tractors take another step forwards in refinement. A single-piece front screen now provides an uninterrupted forward view, with no seams between the lower glass either side of the steering column and the main screen itself. The latest AFS terminal provides improved remote valve and headland management control, further simplifying repetitive field operations to bring about greater efficiency and reduce driver fatigue. In addition, a range of options provides three seating choices, including an industry-exclusive high back Dual Motion low frequency seat in either fabric or leather, and a premium Maximo Evolution seat with red leather upholstery and semi-active suspension.

WORK LONGER.

The cab's panoramic view provides excellent visibility all round, while the bonnet has been designed to guarantee a perfect view of all your implements. For those days when you need to carry on working after dark, you can turn on the bright LED lighting package that will illuminate perfectly 360 degrees around the tractor, giving you outstanding visibility of your implements. With 28,800 lumen lighting power, you will be working in clear light conditions – everything you need to do to get the job done efficiently.



All information on the tractors performance at a glance.

INTUITIVE OPERATION PUTS YOU IN CONTROL

We know how busy you and your operators are, so we make sure you don't waste time getting used to a new control layout when you switch tractors: in every Case IH tractor, from a Maxxum to a Quadtrac, you will find the same control layout. The moment you sit in the cab, you know where everything is; you have all the information you need at a glance on the A-post display and all the controls at your fingertips on the Multicontroller armrest. Full comfort and control in no time at all.

YOUR CONTROL STATION.

The drive logic of the Case IH Multicontroller combines with the ICP intuitive control panel and the AFS™ Pro 700 touch screen monitor to put all of the tractor's functions on the armrest at your fingertips: speed selection, direction changes, throttle, AccuGuide engage, Headland Management Control, electrical remote valves, rear hitch controls, PTO, joystick ... everything is in one place and within easy reach. Operation is so intuitive that even novice drivers will have no problem working at their best from day one.

OPTIMISE YOUR PERFORMANCE

The AFS™ Pro 700 gives you all the information you need on the tractor's performance at a glance, from fuel consumption to engine and PTO power. The touch screen interface is easy to use and you can quickly adjust the settings for different implements and working conditions. To make it even more intuitive, you can customise the different screens to display the information most important to you.

EVERYTHING UNDER CONTROL

The ICP performance instrumentation cluster on the A-pillar tells you everything you need to know about the tractor – engine speed, transmission target speeds, actual ground speed, brake position and drive direction. All is clearly displayed in one place so you have everything under control.



- A** AFS PRO 700 TOUCHSCREEN
- B** MULTICONTROLLER
- C** REMOTE VALVE CONTROLS INCL. JOYSTICK
- D** ICP - INTUITIVE CONTROL PANEL
- E** FRONT-/REAR PTO ON/OFF
- F** HYDRAULIC AND HITCH SETTINGS



ADVANTAGES

- FPT engine technology from 150 to 240 hp (rated) all Stage IV compliant
- Engine Power Management boosts power from 190 to 270 hp
- APM Automatic Productivity Management and ECO Drive helps to cut fuel consumption
- 600 hour service interval



ENGINE TECHNOLOGY POWER AND PERFORMANCE

Puma tractors are built around the latest generation Stage IV-compliant FPT engines, forming the heart of a powertrain that's built to take high-output hard work in its stride. Durable, frugal, reliable and hard-working, these are powerplants which keep on giving, in hp, in torque and in dependability. The Puma range now covers a power band from 150-240 hp (rated), with all models benefiting from an Engine Power Management boost for PTO and transport work taking those figures from 190 hp to 270 hp.

TAKES ON THE HEAVYWEIGHT JOBS – AND THE LIGHTER TASKS TOO.

With a high power to weight ratio which allows them to be ballasted for heavy draft work yet run light for simpler tasks, these are truly universal tractors. And with 600-hour service intervals, they require the minimum of regular scheduled care. That means they spend less time in the yard and more where it matters – in the field, returning the investment you've made in them.

APM AND ECO DRIVE – SYSTEMS THAT SAVE.

All Puma CVX models benefit from Automatic Productivity Management (APM), a system which helps cut fuel consumption by adjusting the engine speed, CVX transmission to keep PTO speed constant with the Multicontroller and travel pedal. The result is the best possible balance of fuel efficiency and power. Engaging Eco Drive enables minimum and maximum engine speeds to be set to match the engine performance to the task in hand, thereby minimising fuel use.

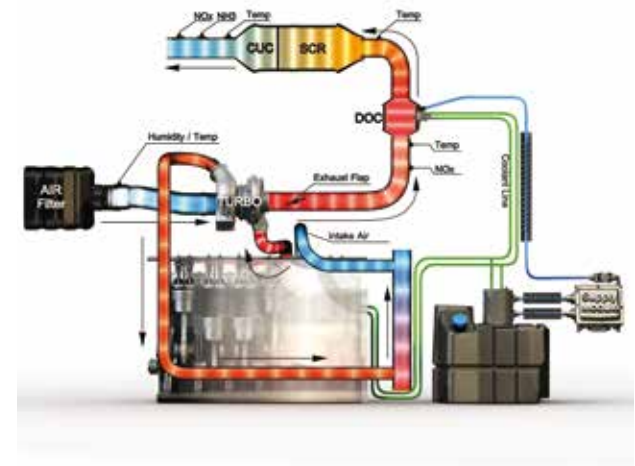

HI-eSCR engine powerful and efficient.

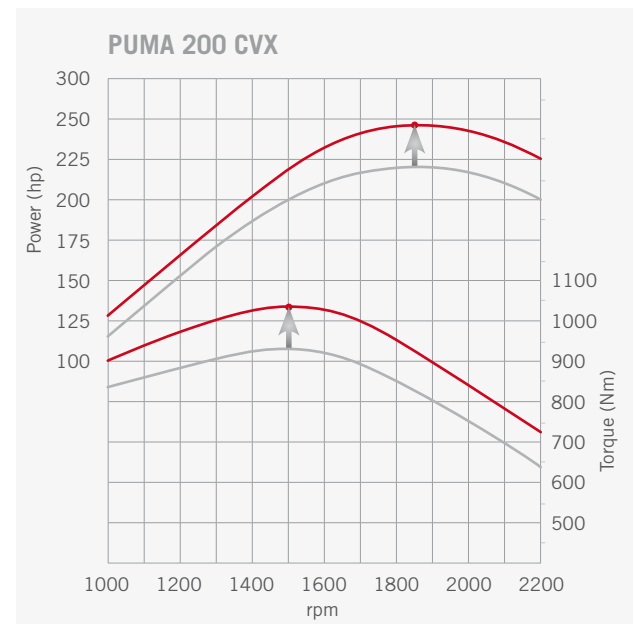

25 HP additional with Power Boost.

PUMA TRANSMISSIONS TO TACKLE ANY TASK

Case IH recognises that no two farm businesses are the same and every one demands different things from its tractors. That's never truer than in the transmission department, where what suits one operation may not be right for another. This is why Puma, one of the most versatile tractor ranges in the Case IH line, is offered with three transmission options.

Puma 150 and 165 models come with a semi-powershift transmission as standard, while available as an option on the 150 and 165 and standard on Puma 185, 200 and 220 models, the powershift transmission provides full clutchless shifting through 19 forward speeds. Both transmissions are available with maximum travel speeds of 40, 40 ECO and 50 kph.

SIMPLE SHIFTING.

The six-speed semi-powershift transmission that forms the standard Puma transmission offering has been designed for simplicity and reliability. It offers clutch-free gear changing that provides slick shifts through six speeds in each range.

OPTIMUM PERFORMANCE.

With the full powershift transmission, all 19 forward speeds can be selected without depressing the clutch. Specifying the creeper transmission brings with it a further ten forward ratios, with speeds as low as 200 m/hr.





Six-speed Semi-Powershift and Full Powershift transmission maximize efficiency and increase productivity in the field and on the road.



Multicontroller™ allows gear change without actuating the clutch.

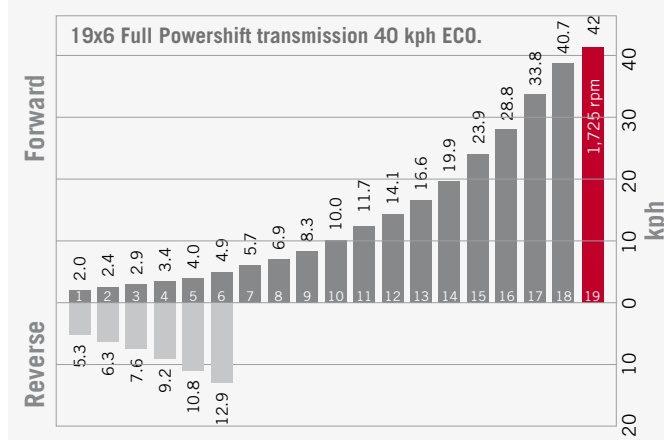

A red Case IH tractor is shown in a field, pulling a blue LEMKEN tillage implement. The tractor is positioned in the center-right of the frame, moving towards the left. The implement is a complex piece of machinery with multiple rollers and blades, designed for soil preparation. The field is a mix of brown soil and green grass, with a clear horizon line in the background. The sky is overcast with light clouds. A red-bordered box on the left side of the image contains a list of advantages.

ADVANTAGES

- Continuously variable transmission
- 50 kph ECO or 40 kph ECO
- DKT™ Double Clutch Technology
- APM Automatic Productivity Management for best fuel efficiency
- Active Stop holds the tractor with load stationary without applying the brakes

THE PUMA CVX TRANSMISSION STEPLESS AND SEAMLESS

Puma 150-240 CVX tractors feature the pioneering Case IH CVX continuously-variable transmission, offering stepless travel with DKT double clutch technology for seamless power transfer and excellent fuel and power efficiency. Automatic Productivity Management (APM) fine-tunes the tractor's settings to minimise fuel consumption. By coordinating the engine, transmission and PTO with the Multicontroller™ or the travel pedal, the ideal balance of fuel efficiency and productivity is achieved.

STEPLESS PRODUCTIVITY.

The CVX drivetrain is as efficient delivering power at creep speeds as it is at its maximum 50 kph travel speed, which is achieved at just 1,750 engine rpm. For even greater economy, Puma 185-240 CVX tractors attain 40 kph at just 1,450 rpm, and reach 50 kph at only 1,550 rpm.

SEAMLESS SHIFTING.

DKT™ Double Clutch Technology eliminates interruptions in the flow of power between gear changes. The result – improved acceleration and better fuel efficiency.

OPTIMUM EFFICIENCY.

Puma CVX tractors feature APM Automatic Productivity Management, creating further fuel savings by automatically reducing engine rpm when full engine power is not required.

ACTIVE STOP.

Active Stop holds the tractor and its load stationary, even on a steep incline, and enables the operator to pull away effortlessly without using the clutch and brakes.



CVX transmission – stepless drive between 0-50 kph



Active Stop holds the tractor stationary without applying brakes



Double clutch technology DKT™ (Doppel Kupplungs Technologie)

A PTO PACKAGE TO POWER ANY IMPLEMENT

Versatility is at the heart of the principles behind Puma. These are tractors capable of handling anything asked of them: compact enough for lighter tasks, powerful enough for heavyweight jobs.

That's as true with PTO-powered implements as it is with others. Puma and Puma CVX models (150-175) are available with rear PTO speeds of 540/540E/1000rpm, while the models from 185 upwards have a 540/540E/1000/1000Erpm package. Up front there is the option of a PTO package which offers 1000 rpm capability at 1895 engine rpm. Soft Start management slowly increases the torque to protect shaft drives.

DIRECT POWER TRANSFER.

With power for the PTO taken directly from the engine flywheel, transmission losses are minimal. For jobs with low power requirements, the 540E/1000E rpm PTO speed is attained at below 1600 engine rpm which cuts down fuel consumption and noise.

SOFT START.

Soft Start works by detecting a higher starting resistance when the PTO is engaged, and steadily increasing the torque load. A hydraulic brake stops the movement of powered implements as soon as the PTO is switched off. The hydraulically activated and electronically controlled system allows for smooth modulation and protects the components.

HEADLAND OPERATION SIMPLIFIED.

Automatic PTO management disengages the PTO when the linkage is raised and re-engages it when it's lowered. The position at which the PTO is engaged and disengaged is adjustable.

DOUBLE YOUR OUTPUT IN EVERY PASS.

Front linkage, PTO and hydraulic outlet packages for Puma models are fully integrated into the tractor. With the likes of a front-end mower on board, they can double or even triple your daily output.

ADVANTAGES

- up to 4-speed PTO option
- PTO Management
- Soft start PTO takes care of your implements
- Front PTO for greater productivity







Seamlessly integrated Front Linkage with a lifting power of up to 3,785 kg.

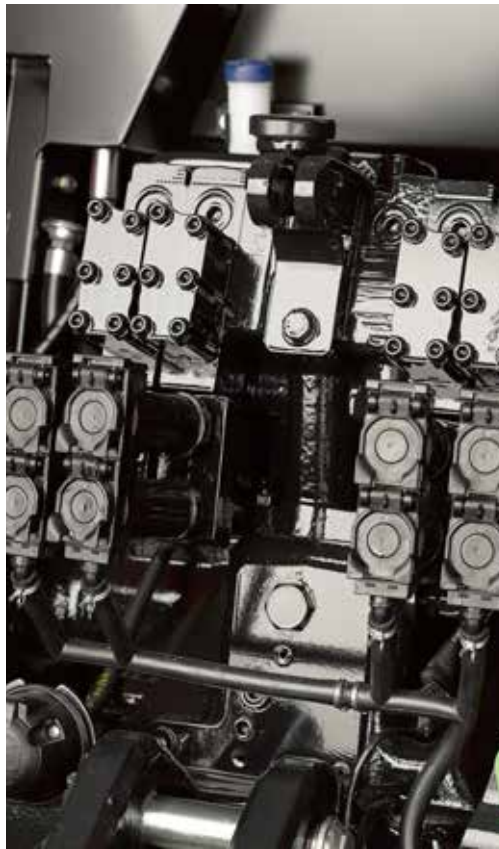

No limits of operation with 5 electronic-hydraulic rear remotes.



Up to four mechanical remote valves available.

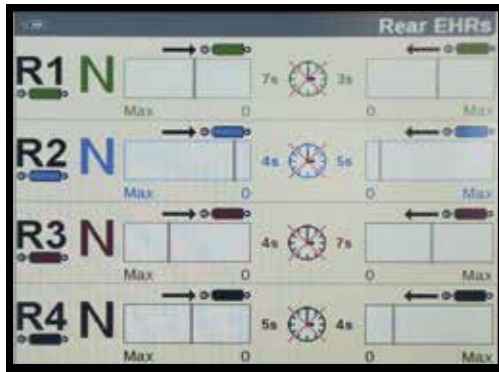

Control your electronic remote valves by the AFS Pro 700™ monitor.



ADVANTAGES

- Up to 10,463 kg lift capacity at the rear
- Up to 3,785 kg front lift capacity
- 4 mechanical or 5 electronic remote valves on Puma 150/175
- 5 electronic rear and 4 electronic mid mount remote valves on Puma 185 upwards



FRONT AND REAR HYDRAULICS VERSATILITY BUILT TO HANDLE THE HEAVIEST IMPLEMENTS

With rear hitch capacity on Case IH Puma tractors topping out at over 10t on the largest models, they will lift the largest implements with ease. The hydraulic system uses an axial piston variable displacement pump with a delivery rate of up to 150 l/min on Puma models and 170 l/min on Puma CVX, guaranteeing fast, effective operation.

POWERFUL HYDRAULICS.

- The rear hydraulics of models 150 to 175 already boast a maximum hitch capacity of 8,257 kg, while for all larger models, this value can be as much as 10,463 kg. This means that even the heaviest attachments can be used without any problems.
- Thanks to the controls for the PTO, hydraulics and a remote valve, which are positioned on the outside of the mudguards, devices can be easily attached and removed by a single operator.
- On the Puma 150-165 models, a maximum of four mechanical or five electrical remote valves are available at the rear of each model, while as many as four mechanical or five electrical remote valves are available on the Puma 150-175 CVX models. All 150-175 models also offer up to three electrical mid-mount valves.
- Models from the Puma 185/185 CVX upward can be fitted with five electrical control units at the rear and four electrical mid-mount valves. In total, therefore, you have up to nine hydraulic control devices at your disposal.
- For EHR's the operator has the possibility to select which lever operates which valve
- The front hitch, which is available as an option, lifts up to 3,568 kg (models 150-175) or as much as 3,785 kg on all larger models.



Easy and safe operation with the external controls.

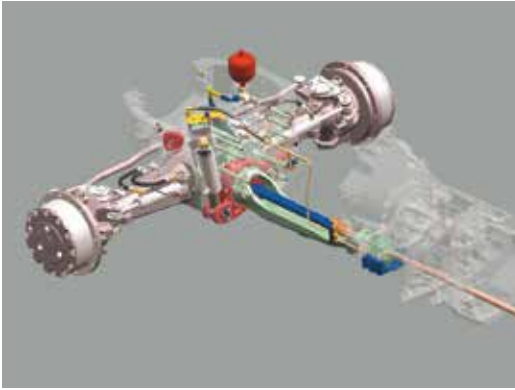

Active suspended front axle

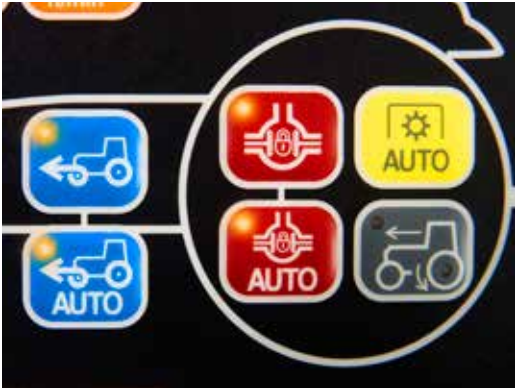

4WD and differential lock management

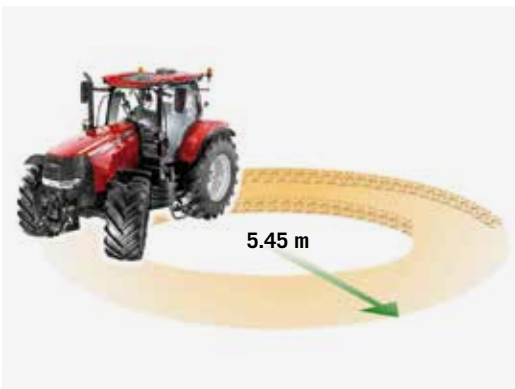

Turning radius of 5.45 m

DRIVE LINE PUTTING THE POWER WHERE IT MATTERS

Puma tractors have a power-to-weight ratio of up to 30 kg/hp, for superb traction with minimal soil disturbance, while Puma remains the only tractor range in its class with the option of ABS braking for both hydraulic and air trailer brake options. Whether in the field or on the road, Puma means peak performance.

THE INDUSTRY'S MOST EFFICIENT DRIVELINE.

Puma automatic 4WD and differential lock systems can be automatically switched on and off where necessary, to combine minimal wheel slippage with maximum ground protection. The standard Ride Control system minimises pitching movements when transporting heavy mounted implements.

FRONT AXLE SUSPENSION.

Optional front axle suspension increases comfort, improves handling and counteracts tractor pitching caused by heavy rear-mounted implements. A sophisticated damping system provides maximum stability and offers automatic, load-dependent self-levelling. Where front axle suspension is specified, an 'active' system is used in the Puma 185 and above, with sensors monitoring various parameters such as acceleration, gear changing, brake actuation, terrain, travel direction change and hitch load. The result is excellent driving stability and comfort.

ABS REASSURANCE: SAFETY AND STABILITY.

On Puma 185 and 185 CVX models and upwards equipped with optional ABS braking, high-sensitivity sensors monitor wheel speeds and transfer this information to the ABS system, to control the braking action regardless of the driver's impact on the brake pedals, for full safety, stability and manoeuvrability. The system is enhanced by 'Steer-by-ABS' which prevents a braked wheel from locking, and 'Auto-Steer-by-Brake', which significantly reduces the turning







ABS ANTI-LOCK BRAKING SYSTEM STOP QUICKLY AND CONFIDENTLY

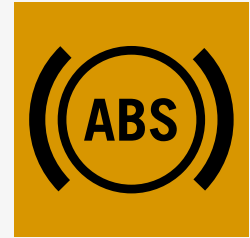

If your tractor spends a lot of time on the road, you'll quickly recognise the value of the Case IH Anti-lock Braking System (ABS). Available on all models 185 and above, it helps ensure steering predictability under heavy braking.

INTELLIGENT BRAKING

ABS prevents wheel lock-up when braking, even with maximum force. The wheels maintain traction and respond to steering, so skidding, pitching and jack-knifing risks are significantly reduced, while cornering characteristics are improved. At speeds over 12kph, the single wheel braking option is automatically disabled, further improving safety.

PUMA FULL POWERSHIFT WITH HILLHOLDER

Hillholder eases the driver's workload when stopping on an incline and when taking off again, releasing them gradually to eliminate any risk of rolling back or stalling.

STEER-BY-ABS

Another unique and advanced feature, Steer-By-ABS significantly reduces the tractor turning radius at the headland as the ABS prevents the inner wheel from locking when a single wheel brake pedal is applied.

AUTO-STEER-BY-BRAKE

This system automatically integrates single wheel braking into the steering process in the field. When activated, the inside wheel brakes automatically when the steering wheel turns, reducing the turning radius. The ABS prevents the wheel from locking to minimise soil damage.

TRAILER SAFETY

The ABS system is compatible with pneumatic and hydraulic trailer brakes, enhancing the road safety both of tractor operators and of others on the road. A trailer socket also comes standard with ABS for synchronization of braking between the tractor and the trailer.

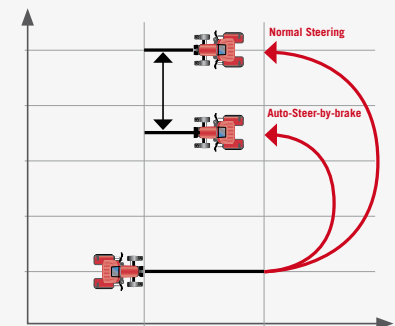



The precision and handling of automatic steering systems on farming vehicles were assessed in the DLG focus test “Automatic Steering Systems”.

Average precision in cm

(taking into account machine-dependent variations)

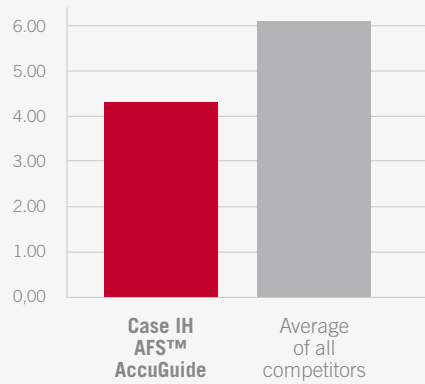

Summary:

“...The approved steering system from Case IH offers a system precision range of 3-5 when used with a local RTK station...”

For the full test, see www.dlg-test.de/tests/6156F.pdf or simply use your smartphone to scan the QR code.



ADVANTAGES

- GLONASS/GPS Antenna
- Low cost RTX signal solution
- Optional High Accuracy RTK Signal
- Integrated AccuGuide AutoGuidance
- Virtual dashboard with parameter monitoring
- Alerts when a predefined value is breached such as a geo fence

AFS SUPPORT CE



0800 0281 910
afssupporteur@caseih.com



INTEGRATED PRECISION FOR EFFICIENT PRODUCTION



AFS AccuGuide: GPS and GLONASS based guidance for ultimate precision independent of crop conditions. With RTK accuracy levels down to 2.5 cm available.



xFill bridges RTK signal gaps of up to 20 minutes.



Accurately pinpoint all machines with AFS-Connect™.

Case IH Advanced Farming Systems (AFS™) have been at the forefront of precision farming for more than a decade, giving farmers the ability to control the entire crop production cycle. Case IH AFS™ tools include everything you need to achieve repeatable accuracy down to 2.5 cm, reduce overlaps and cut input costs – and maximize your yield potential.

ADVANCED VEHICLE CONTROL.

If it's interactive vehicle set-up and control you need then look no further than the AFS Pro 700 touch screens: monitor fuel usage and work rates, connect external cameras, keep job records and manage ISOBUS implements. The AFS Pro touch screens are interactive, fully customizable and portable between your Case IH fleet.

VEHICLE GUIDANCE SOLUTIONS.

If it's a guidance system you are looking for, we have simple 'plug and play' lightbar steering kits through to fully automated and integrated solutions (AccuGuide). With the range topping RTK systems we can make you pass perfect down to 2.5 cm. The xFill option can bridge RTK signal gaps of up to 20 minutes.

AFS FARM MANAGEMENT SOFTWARE.

Many variables apply in farming and it is key to understand what is happening and why. It's time to manage your farming operation by making decisions based on facts. With the AFS™ Farm Management software package from Case IH you can see, field by field, the tasks performed, the work rates achieved, the fuel used during each task and, most importantly, your yield. Plan for the future today.

AFS CONNECT™ TELEMATICS.

The Case IH AFS Connect™ telematics system allows farm owners and managers to monitor and manage their machinery from the farm office, tracking machines in real time on the farm computer to observe how they are performing through the use of precision guidance GPS signals and wireless data networks. Analysing the data it provides helps to improve logistics, minimise fuel consumption and maximise performance.

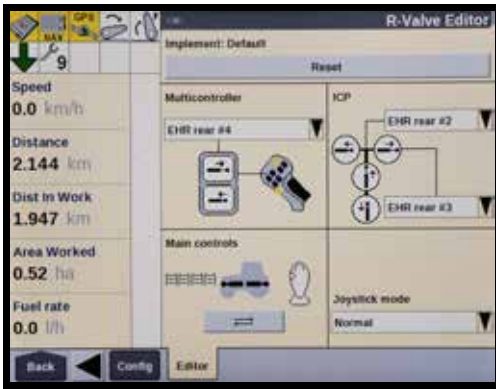

Individually configure the lever to the remote valve.

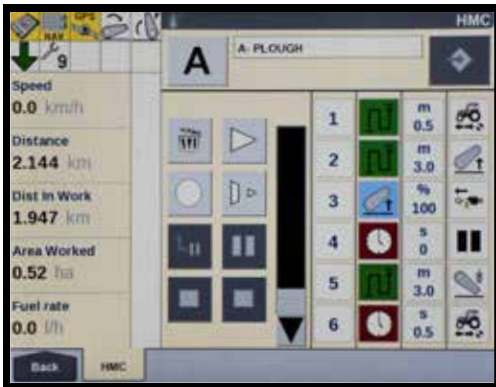

Headland Management Control II.

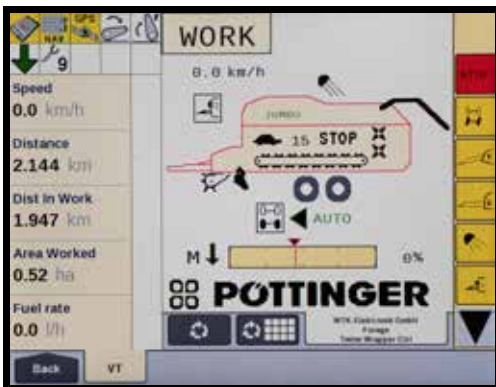

ISOBUS Class III compatibility.



- ADVANTAGES**
- Intuitive AFS Pro 700 touch screen
 - Control tractor and implements with ISOBUS Class III connection
 - Headland Management Control II each step is timed or distance recorded
 - Improved productivity with up-to-the-minute information



INTERACTIVE INTEGRATED INTUITIVE

Case IH Advanced Farming Systems are within easy reach on the AFS™ Pro 700 touchscreen monitor, integrated into the armrest of the Puma and Puma CVX models. In addition, to complete automation of all the tractor's key functions, including the sequencing of up to 32 headland functions, the AFS screen also keeps track of the work done, fuel consumption, operating costs and much more. Here are just a few examples:

KEY FEATURES INCLUDE:

- Performance monitoring: record overall performance, performance for each day and performance for each job. All data from the AFS monitors can be saved to a USB stick for analysis back at the office if required.
- Vehicle settings: a series of AFS screens allow you to fine-tune the tractor's settings. It is easy to set the flow rates and timers for each of the remote valves, giving you an excellent overview of the whole setup.
- Hitch notebook: this screen allows you to save the settings for each implement according to the working conditions. Next time you attach the plough, for example, you just need to open the notebook, choose the right set-up and away you go.
- The HMC II headland management control system has been designed to make the job of the operator easier when turning at the end of the row during in-field operations. A headland sequence can either be recorded on the go or created in advance in the farmyard. When in record mode, each step will be timed or distance recorded and can be used to build an HMC sequence.
- ISOBUS Class III compatibility: hook up any compatible machine to display the user interface for the machine on the AFS monitor. Now you are able to operate the machine easily and interactively by pressing the control buttons on the AFS monitor screen. Depending on the implement ISOBUS Class III will automatically control some tractor functions like speed, hitch, PTO and EHR. You do not need a separate control pendant or cables inside the cab.
- Video input: you can display a live video feed from a camera positioned at the rear end of a loader wagon or baler. This means you can monitor what is going on behind you without having to take your eyes off the work area in front of you.
- A variety of vehicle guidance solutions are available to match your needs for precision. A fully automated and integrated solution, which is factory installed, gives you the pinpoint accuracy you need for high value crops. Alternatively, a simple plug and play lightbar steering kit can be installed.



AFS PRO 700™ TOUCHSCREEN MONITOR

Enhanced vehicle control and additional productivity with programmable functions and settings, as well as notebook and ISOBUS Class III compatibility.





DAILY MAINTENANCE COMPLETED WITH EASE – **FAST AND SIMPLE**

MAKE A PRODUCTIVE START – AND STAY PRODUCTIVE THROUGHOUT THE DAY!

When you have a busy working day ahead of you, time-consuming maintenance tasks are the last thing you want to do; even without important field and transport work to complete, you will certainly have better things to spend your time on than machine maintenance. For this reason, we have designed the Puma and the Puma CVX to be maintenance-friendly across the board; the daily checks are quick to complete. Do your checks and you're ready to go!

OPTIMUM OPERATING TIME, MINIMAL MAINTENANCE COSTS.

With the Puma and Puma CVX models, maintenance times and costly downtime are minimized, allowing you to work productively. Productivity is also increased by the unrivaled 600-hour maintenance intervals; these maintenance intervals are just one example of a number of characteristics of the Puma and Puma CVX that allow you to keep your operational readiness at a high level and your servicing and repair costs low.



CLEANING COMPLETE IN NEXT TO NO TIME
The radiators can be swung out to enable easy cleaning.



EASY ACCESS
The single-piece engine hood is raised using a gas strut and can be locked at an angle of 45° and 90°, even with front attachments fitted.



FAST DAILY CHECKS
The engine oil can be checked and topped up when the bonnet is closed.





SYSTEM SOLUTIONS

When you buy a Case IH machine, you can be sure not only that you're buying the best product, but also that you've got the best dealer back-up behind you. Case IH dealers can offer advice on selecting and financing the right machine, will ensure they deliver what you need when you need it, and will then continue to back you and your equipment with the service and spare parts supply you'd expect from a name as trusted as Case IH.



ALL THE PARTS AND SERVICE TO KEEP YOUR EQUIPMENT RUNNING.

Find the full line of Case IH parts and components at your local dealer, plus full service maintenance programmes and industry leading warranties. It's expertise applied by skilled, factory-trained service professionals committed to providing you maximum uptime, season after season.



AROUND THE CLOCK. AROUND THE COUNTRY.

Case IH Max Service is a customer support service that provides 24-hour, seven-day-a-week access to the people, products and parts support needed to keep your operation running during the times most critical to your profitability. Max Service backs up your dealer with every resource available to Case IH, to help maximise uptime and productivity of Case IH equipment and increase your return on investment through access to product experts and 24/7 emergency breakdown assistance.



AN OPTIMAL FINANCING SOLUTION FOR EVERY INVESTMENT.

CNH Industrial Capital is the financing company for Case IH. Our employees are financial experts and have many years of experience in agriculture. We do not only know about Case IH products and the market, we also understand the individual requirements of your operations. Therefore we are always able to offer you a financial solution for your new investments that is tailored specifically to your operational requirements and respective machine usage in the form of loans, rent or leasing. Our most important goal is improving the profitability of your investments! Therefore you can combine every CNH Industrial Capital Financing with Capital accident and breakdown cover, as machine breakdown or repair insurance, in order to exclude risks to your investment and ensure greater planning reliability.



VISIT OUR FANSHOP AT
WWW.CASEIH.COM

MODELS	PUMA 150	PUMA 165	PUMA 185	PUMA 200	PUMA 220
ENGINE	FPT	FPT	FPT	FPT	FPT
Number of cylinders	6	6	6	6	6
Type	Common Rail Diesel engine with 24 valves, turbo. and intercooled		Common Rail Diesel engine with 24 valves, turbocharged and intercooled		
Emission level	Stage IV		Stage IV		
Capacity (cm ³)	6,700	6,700	6,700	6,700	6,700
Maximum power ECE R120 ³⁾ Power Management (kW/hp(CV))	140 / 190	155 / 210	166 / 225	180 / 245	192 / 260
Maximum power ECE R120 ³⁾ (kW/hp(CV))	121 / 165	132 / 180	147 / 200	162 / 220	177 / 240
... at engine speed (rpm)	1,800 - 1,900	1,800 - 1,900	1,800 - 1,900	1,800 - 1,900	1,800 - 1,900
Rated power ECE R120 ³⁾ Power Management (kW/hp(CV))	129 / 175	140 / 190	151 / 205	165 / 225	177 / 240
Rated power ECE R120 ³⁾ (kW/hp(CV))	110 / 150	121 / 165	132 / 180	147 / 200	162 / 220
... at engine speed (rpm)	2,200	2,200	2,200	2,200	2,200
Maximum torque Power Management (Nm @ 1,500 rpm)	805	875	940	1,035	1,100
Maximum torque (Nm @ 1,500 rpm)	700	770	840	930	1,000
Torque rise Standard / Power Management (%)	51 / 45	50 / 42	54 / 47	46 / 45	45 / 44
Fuel tank, diesel / urea (litres)	330 / 48	330 / 48	390 / 48	390 / 48	390 / 48
TRANSMISSION					
18x6 Semi- / Full Powershift 40 kph	○ / ●	○ / ●	- / ●	- / ●	- / ●
19x6 Semi- / Full Powershift Economy 40 kph @ reduced rpm	○ / ○	○ / ○	- / ○	- / ○	- / ○
19x6 Semi- / Full Powershift 50 kph	○ / ○	○ / ○	- / ○	- / ○	- / ○
Powershuttle	●	●	●	●	●
Creeper	○	○	○	○	○
Rear axle diff-lock type	Multi disc wet plate with management system		Multi disc wet plate with management system		
Service brake	Hydraulically operated multiple wet disc brake, self adjusting		Hydraulically operated multiple wet disc brake, self adjusting		
POWER TAKE OFF					
Type	Electro-hydraulic with Auto PTO control available		Electro-hydraulic with Auto PTO control available		
Speeds Standard (Option)	540 / 540E / 1,000 (540E / 1,000 / 1,000E) (both with optional ground drive)		540 / 540E / 1,000 / 1,000E (540E / 1,000 or 1,000 / 1,000E)		
Engine speeds Standard (Option) (rpm)	1,969 / 1,546 / 1,893 (1,592 / 1,893 / 1,621)		1,931 / 1,598 / 1,912 / 1,583 (1,569 / 1,893 or 1,893 / 1,700)		
Shaft type Standard (Option)	1 3/8" 21 splines (1 3/8" 6 splines)		1 3/8" 21 splines (1 3/8" 6 splines or 1 3/4" 20 splines)		
FRONT PTO AND HITCH					
Front PTO 1,000 Speed @ 1,895 rpm	○	○	○	○	○
Front hitch lift capacity (kg)	3,568	3,568	3,785	3,785	3,785
FOUR-WHEEL DRIVE AND STEERING (DRIVELINE)					
Type	Electro-hydraulic with management system, differential lock as standard, front axle suspension optional		Electro-hydraulic with management system, differential lock as standard, front axle suspension optional		
ABS Anti-lock braking system	-	-	○	○	○
Front axle suspension	○	○	● / Active	● / Active	● / Active
Steering angle (°)	55	55	55	55	55
Min. turning radius 1) track setting 1,829mm (m)	5.45	5.45	6.1	6.1	6.1
HYDRAULIC SYSTEM					
System type	Variable displacement, pressure flow compensated pump		Variable displacement, pressure flow compensated pump		
Max. pump flow rate Standard / Optional (l/min)	110 / -	110 / -	120 / 150	120 / 150	120 / 150
System pressure (bar)	210	210	210	210	210
Control type	Electronic Hitch Control (EHC) with cushion ride control		Electronic Hitch Control (EHC) with cushion ride control		
Max. lift capacity (kg)	8,257	8,257	10,463	10,463	10,463
OECD lift capacity through range @ 610 mm (kg)	6,616	6,616	7,280	7,280	7,280
Max. number of rear remote valves	4 mechanical or 5 electronic		4 mechanical or 5 electronic		
Max. number of mid mount valves with electronic joystick	3 electr.	3 electr.	3 electr.	3 electr.	3 electr.
Remote valve timer control	1 - 60 seconds on all models		1 - 60 seconds on all models		
Category type	Cat II / III	Cat II / III	Cat III	Cat III	Cat III
Slip control	○	○	○	○	○

● Standard Equipment ○ Optional Equipment - Not available ¹⁾ With standard tyres ²⁾ Other tyres on request ³⁾ ECE R120 correspond to ISO 14396 and 97 / 68 / EC

MODELS	PUMA 150 CVX	PUMA 165 CVX	PUMA 175 CVX	PUMA 185 CVX	PUMA 200 CVX	PUMA 220 CVX	PUMA 240 CVX
ENGINE	FPT	FPT	FPT	FPT	FPT	FPT	FPT
Number of cylinders	6	6	6	6	6	6	6
Type	Common Rail Diesel engine with 24 valves, turbo. and intercooled			Common Rail Diesel engine with 24 valves, turbocharged and intercooled			
Emission level	Stage IV			Stage IV			
Capacity (cm ³)	6,700	6,700	6,700	6,700	6,700	6,700	6,700
Maximum power ECE R120 ³⁾ Power Management (kW/hp(CV))	140 / 190	155 / 210	166 / 225	166 / 225	180 / 245	192 / 260	199 / 270
Maximum power ECE R120 ³⁾ (kW/hp(CV))	121 / 165	132 / 180	132 / 180	147 / 200	162 / 220	177 / 240	192 / 260
... at engine speed (rpm)	1,800 - 1,900	1,800 - 1,900	1,800 - 1,900	1,800 - 1,900	1,800 - 1,900	1,800 - 1,900	1,800 - 1,900
Rated power ECE R120 ³⁾ Power Management (kW/hp(CV))	129 / 175	140 / 190	151 / 205	151 / 205	165 / 225	177 / 240	192 / 260
Rated power ECE R120 ³⁾ (kW/hp(CV))	110 / 150	121 / 165	132 / 180	132 / 180	147 / 200	162 / 220	177 / 240
... at engine speed (rpm)	2,200	2,200	2,200	2,200	2,200	2,200	2,200
Maximum torque Power Management (Nm @ 1,500 rpm)	805	875	940	940	1,035	1,100	1,160
Maximum torque (Nm @ 1,500 rpm)	700	770	770	840	930	1,000	1,100
Torque rise Standard / Power Management (%)	51 / 45	50 / 42	50 / 47	54 / 47	46 / 45	45 / 44	45 / 43
Fuel tank, diesel / urea (litres)	330 / 48	330 / 48	330 / 48	390 / 48	390 / 48	390 / 48	390 / 48
TRANSMISSION							
Continuously variable transmission 50kph or 40kph ECO	●	●	●	●	●	●	●
Powershuttle	●	●	●	●	●	●	●
Rear axle diff-lock type	Multi disc wet plate with management system			Multi disc wet plate with management system			
Service brake	Hydraulically operated multiple wet disc brake, self adjusting			Hydraulically operated multiple wet disc brake, self adjusting			
POWER TAKE OFF							
Type	Electro-hydraulic with Auto PTO control available			Electro-hydraulic with Auto PTO control available			
Speeds Standard (Option)	540 / 540E / 1,000 (540E / 1,000 / 1,000E) (both with optional ground drive)			540 / 540E / 1,000 / 1,000E (540E / 1,000 or 1,000 / 1,000E)			
Engine speeds Standard (Option) (rpm)	1,969 / 1,546 / 1,893 (1,592 / 1,893 / 1,621)			1,931 / 1,598 / 1,912 / 1,583 (1,569 / 1,893 or 1,893 / 1,700)			
Shaft type Standard (Option)	1 3/8" 21 splines (1 3/8" 6 splines)			1 3/8" 21 splines (1 3/8" 6 splines or 1 3/4" 20 splines)			
FRONT PTO AND HITCH							
Front PTO 1,000 Speed @ 1,895 rpm	○	○	○	○	○	○	○
Front hitch lift capacity (kg)	3,568	3,568	3,568	3,785	3,785	3,785	3,785
FOUR-WHEEL DRIVE AND STEERING (DRIVELINE)							
Type	Electro-hydraulic with management system, differential lock as standard, front axle suspension optional			Electro-hydraulic with management system, differential lock as standard, front axle suspension optional			
ABS Anti-lock braking system	-	-	-	○	○	○	○
Front axle suspension	○	○	○	● / Active	● / Active	● / Active	● / Active
Steering angle (°)	55	55	55	55	55	55	55
Min. turning radius ¹⁾ track setting 1,829mm (m)	5.45	5.45	5.45	6.1	6.1	6.1	6.1
HYDRAULIC SYSTEM							
System type	Variable displacement, pressure flow compensated pump			Variable displacement, pressure flow compensated pump			
Max. pump flow rate Standard / Optional (l/min)	140 / 160	140 / 160	140 / 160	150 / 170	150 / 170	150 / 170	150 / 170
System pressure (bar)	210	210	210	210	210	210	210
Control type	Electronic Hitch Control (EHC) with cushion ride control			Electronic Hitch Control (EHC) with cushion ride control			
Max. lift capacity (kg)	8,257	8,257	8,257	10,463	10,463	10,463	10,463
OECD lift capacity through range @ 610 mm (kg)	6,616	6,616	6,616	7,280	7,280	7,280	7,280
Max. number of rear remote valves	4 mechanical or 5 electrical			5 electrical			
Max. number of mid mount valves with electronic joystick	3 electr.	3 electr.	3 electr.	3 electr.	3 electr.	3 electr.	3 electr.
Remote valve timer control	1 - 60 seconds on all models			1 - 60 seconds on all models			
Category type	Cat II / III	Cat II / III	Cat II / III	Cat III	Cat III	Cat III	Cat III
Slip control	○	○	○	●	●	●	●

● Standard Equipment ○ Optional Equipment - Not available ¹⁾ With standard tyres ²⁾ Other tyres on request ³⁾ ECE R120 correspond to ISO 14396 and 97 / 68 / EC

MODELS	PUMA 150	PUMA 165	PUMA 185	PUMA 200	PUMA 220
WEIGHT					
Approximate shipping weight std. / suspended front axle (kg)	6,480 / 6,782	6,480 / 6,782	6,950 / 7,300	6,950 / 7,300	6,950 / 7,300
Permissible total weight (kg)	10,500	10,500	13,000	13,000	13,000
Max. permissible weight front (kg)	4,900	4,900	6,000	6,000	6,000
Max. permissible weight rear (kg)	7,800	7,800	9,500	9,500	9,500
DIMENSIONS ¹⁾					
A: Max. length std. / suspended front axle (mm)	5,240 / 5,316	5,240 / 5,316	5,467 / 5,467	5,467 / 5,467	5,467 / 5,467
B: Total height (mm)	3,026	3,026	3,068	3,068	3,068
C: Minimum width across rear fenders (narrow / wide type fender) (mm)	2,060 / 2,476	2,060 / 2,476	2,060 / 2,476	2,060 / 2,476	2,060 / 2,476
D: Wheel base standard axle / front axle suspension (mm)	2,734 / 2,789	2,734 / 2,789	2,884 / 2,884	2,884 / 2,884	2,884 / 2,884
E: Height at centre of rear axle, highest point (susp.cab) (mm)	2,210	2,210	2,210	2,210	2,210
F: Track setting front (mm)	1,325-2,285	1,325-2,285	1,538-2,260	1,538-2,260	1,538-2,260
rear (mm)	1,430-2,230	1,430-2,230	1,530-2,230	1,530-2,230	1,530-2,230
G: Max. ground clearance without drawbar or tow hook (mm)	554	554	523	523	523
STANDARD TYRES ²⁾					
Front	480 / 70 R28	480 / 70 R28	600 / 65 R28	600 / 65 R28	600 / 65 R28
Rear	580 / 70 R38	580 / 70 R38	650 / 65 R42	650 / 65 R42	650 / 65 R42

MODELS	PUMA 150 CVX	PUMA 165 CVX	PUMA 175 CVX	PUMA 185 CVX	PUMA 200 CVX	PUMA 220 CVX	PUMA 240 CVX
WEIGHT							
Approximate shipping weight std. / suspended front axle (kg)	6,480 / 6,782	6,480 / 6,782	6,480 / 6,782	6,950 / 7,300	6,950 / 7,300	6,950 / 7,300	6,950 / 7,300
Permissible total weight (kg)	11,500	11,500	11,500	13,000	13,000	13,000	13,000
Max. permissible weight front (kg)	4,900	4,900	4,900	6,000	6,000	6,000	6,000
Max. permissible weight rear (kg)	8,500	8,500	8,500	9,500	9,500	9,500	9,500
DIMENSIONS ¹⁾							
A: Max. length std. / suspended front axle (mm)	5,240 / 5,316	5,240 / 5,316	5,240 / 5,316	5,467 / 5,467	5,467 / 5,467	5,467 / 5,467	5,467 / 5,467
B: Total height (mm)	3,026	3,026	3,026	3,068	3,068	3,068	3,068
C: Minimum width across rear fenders (narrow / wide type fender) (mm)	2,060 / 2,476	2,060 / 2,476	2,060 / 2,476	2,060 / 2,476	2,060 / 2,476	2,060 / 2,476	2,060 / 2,476
D: Wheel base standard axle / front axle suspension (mm)	2,734 / 2,789	2,734 / 2,789	2,734 / 2,789	2,884 / 2,884	2,884 / 2,884	2,884 / 2,884	2,884 / 2,884
E: Height at centre of rear axle, highest point (susp.cab) (mm)	2,210	2,210	2,210	2,210	2,210	2,210	2,210
F: Track setting front (mm)	1,325-2,285	1,325-2,285	1,325-2,285	1,538-2,260	1,538-2,260	1,538-2,260	1,538-2,260
rear (mm)	1,430-2,230	1,430-2,230	1,430-2,230	1,530-2,230	1,530-2,230	1,530-2,230	1,530-2,230
G: Max. ground clearance without drawbar or tow hook (mm)	554	554	554	523	523	523	523
STANDARD TYRES ²⁾							
Front	480 / 70 R28	480 / 70 R28	480 / 70 R28	600 / 65 R28	600 / 65 R28	600 / 65 R28	600 / 65 R28
Rear	580 / 70 R38	580 / 70 R38	580 / 70 R38	650 / 65 R42	650 / 65 R42	650 / 65 R42	650 / 65 R42

● Standard Equipment ○ Optional Equipment - Not available ¹⁾ With standard tyres ²⁾ Other tyres on request ³⁾ ECE R120 correspond to ISO 14396 and 97 / 68 / EC

 Safety never hurts! Always read the Operator's Manual before working with any equipment. Inspect equipment before using it, and be sure it is operating properly. Follow the product safety signs, and use any safety features provided. This literature has been published for worldwide circulation. The standard and optional equipment and the availability of individual models may vary from one country to the next. Case IH reserves the right to undertake modifications without prior notice to the design and technical equipment at all times without this resulting in any obligation whatsoever to make such modifications to units already sold. Whilst every effort is made to ensure that the specifications, descriptions and illustrations in this brochure are correct at the time of going to press, these are also subject to change without prior notice. Illustrations may show optional equipment or may not show all standard equipment. Case IH recommends **AKCELA** lubricants.

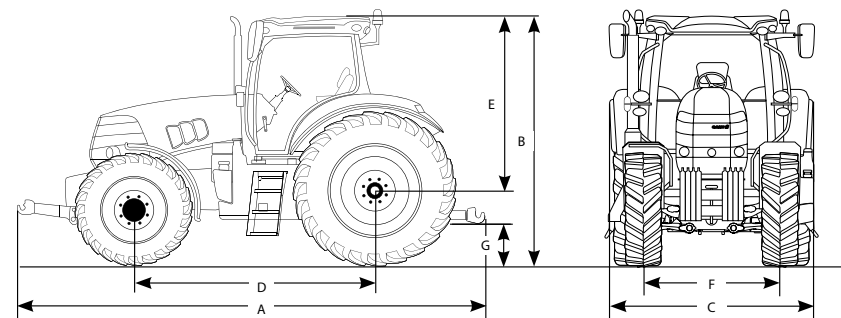

CNH Industrial Österreich GmbH, Steyerer Straße 32, 4300 Sankt Valentin, Austria

MADE IN AUSTRIA BUILT WITH PASSION

Every Case IH Puma and Puma CVX carries the flag for Austrian engineering and manufacturing excellence. Home to the Case IH European Headquarters, the St. Valentin plant relies on the passion and expertise of its engineers and production workers, as well as its state-of-the-art assembly lines, to produce 28 different tractor models ranging from 99 to 240 hp with the highest quality and precision. Ninety percent of tractors produced in St Valentin are exported, carrying its culture of excellence around the world.

AWARD-WINNING ST. VALENTIN

The CNH Industrial tractor plant in St. Valentin, Austria, performs impressively in the annual World Class Manufacturing (WCM) audit. A success attributed to world-class production and highly-qualified employees. WCM stands for competence, quality and performance of enthusiastic staff. Processes are optimised and testing, as well as controls, follow strict regulations which go far beyond common standards. The clear focus is to deliver machines which are ideal for the individual farmer.

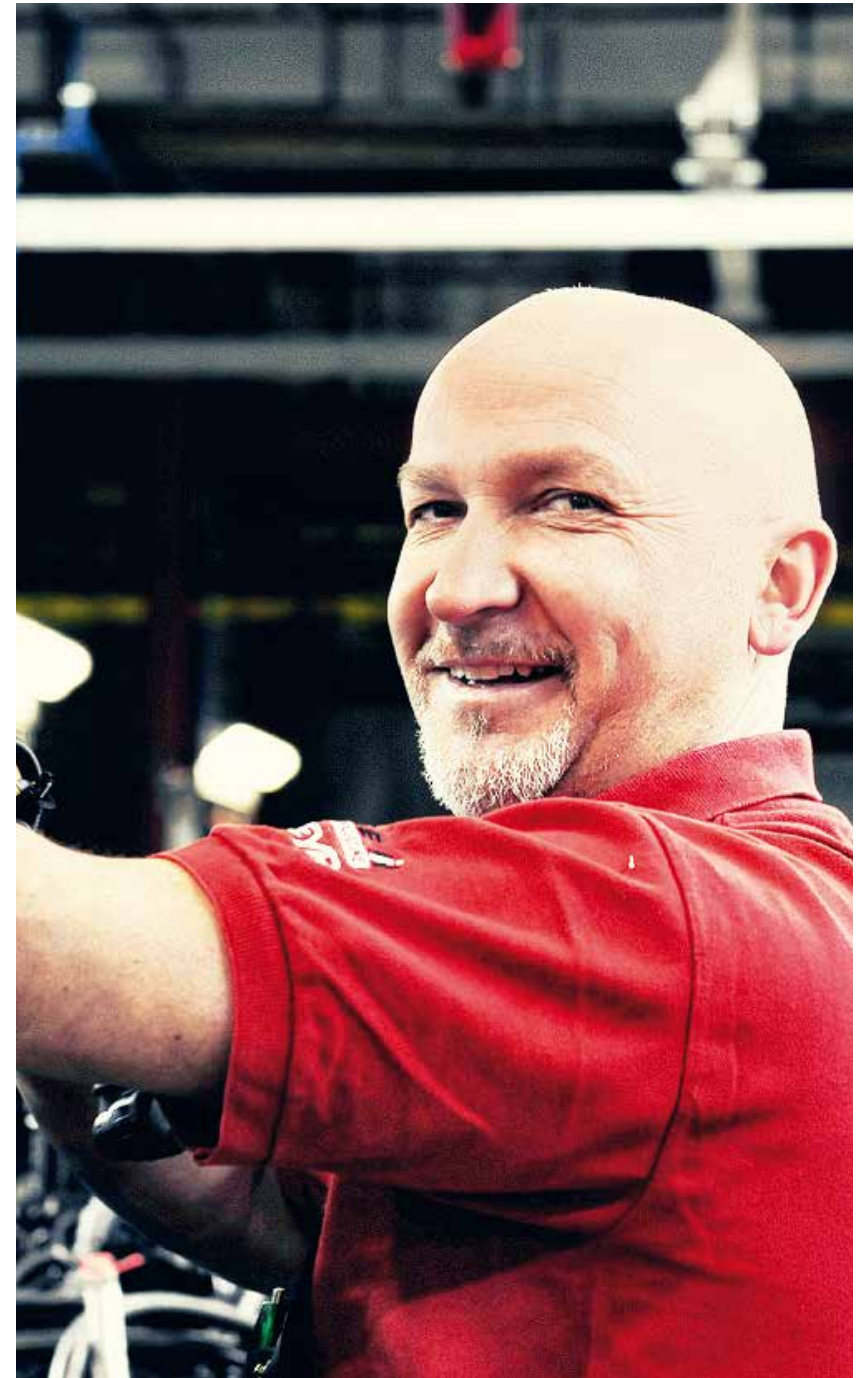



www.caseih.com