



THE POWER OF GREEN

BiG X

680 · 780 · 880 · 1180

Forage harvesters





BiG X

Forage harvesters

- High-power and fuel efficient engines from 687 hp to 1156 hp.
- 6 intake rollers for boosted reliability and a top quality chop
- **MaxFlow** chopping drums with 20, 28, 36 blades; Biogas drums with 40 and 48 blades
- Roller and disc conditioners for all applications
- KRONE **VariLOC** for flexible choice of long and short chops



- KRONE **VariQuick** for fast changeovers to conditioning or grass cutting
- Convenient hoop coupler for easy attachment to the base machine
- Enormous agility from independent wheel suspension
- Height-adjustable comfort cab for optimum visibility



BiG X 680 · 780 · 880 · 1180, the XXL forage harvesters from KRONE for outputs of 687hp to 1156hp. They not only impress by their high efficiency and chop quality but also by high operator comfort and easy handling.

KRONE OptiMaize	4
The crop flow	8
The intake system	10
The chopping assembly	12
The Biogas drums	14
The OptiMaxx roller conditioners	16
Disc conditioner	20
VariLOC22VariQuick	24
VariStream	26
StreamControl	28
The headers	30
EasyFlow	32
XDisc	36
EasyCollect	40
XCollect	44
The engines	48
The driveline	50
The running gear	52
Extra features	56
The multiple tank concept	58
The cab	60
Operator Assist Systems	64
Technical Data	68



KRONE OptiMaize

- KRONE chopping technology for optimum maize forage quality
- **OptiMaize S, M, L, XL** for variable chopping lengths from 4 mm to 30 mm (0.2" to 1.2")
- KRONE **MaxFlow** and Biogas drums with different blade specifications combine for producing the chops length you need
- KRONE corn conditioners ensure optimum fracturing and kernel treatment
- KRONE **VariLOC** for flexible long and short chops without conversing the machine

OptiMaize brings full flexibility to all KRONE BiG X harvesters, allowing them to produce any type of chop length livestock farmers and Biogas producers call for. MaxFlow and Biogas drums are available with various numbers of blades and combine with matching KRONE conditioners to deliver perfect 4-30 mm (0.2"-1.2") chops and the most intensive treatment. The BiG X offers this wide range of chops without operators having to swap or refit the chopping drum – simply by reducing the cutting frequency with the help of VariLOC.

OptiMaize			
Model	LOC	Application	Drum type
OptiMaize S	4 mm – 7 mm (0.2" – 0.3")	Biogas	Biogas (40 blades) or MaxFlow (36 blades)
OptiMaize M	8 mm – 10 mm (0.3" – 0.4")	Dairy feed rations with ~40 % maize Beef bulls	MaxFlow (36 blades) or MaxFlow (28 blades)
OptiMaize L	11 mm to 19 mm (0.4" – 0.7")	Dairy feed rations with ~60 % maize	MaxFlow (28 blades) or MaxFlow (20 blades)
OptiMaize XL	20 mm – 30 mm (0.8" – 1.2")	Dairy feed rations with >80 % maize	MaxFlow (20 blades)



‘OptiMaizing’ – a KRONE concept for BiG X forage harvesters

The OptiMaize concept was developed by KRONE and aims at producing forage of a superior quality. Livestock farmers ask for different chop lengths that meet different aims in the silage maize ration. The smaller the amount of fibres in the ration, the longer should the maize chops be to suit the needs of ruminants.

By comparison, chop lengths should be short when the maize is used to fuel Biogas plants whereas the feed rations for beef bulls and dairy cows require much longer chop lengths to add structure to the ration. KRONE OptiMaize combines various chopping drums (see table) and conditioners that enable BiG X forage harvesters to produce short and long chops of maize allowing machine owners to respond to individual customer needs. If you have to produce short biogas maize chops in the morning but coarse maize chops for animal feed in the afternoon,

you will find KRONE VariLOC the ideal solution for you. This is a mechanical gearbox which forms an integral part of the pulley that drives the drum belt and that reduces drum speed from 1250 rpm to 800 rpm within just a few minutes. This reduces the cutting frequency and increases the range of available chop lengths by up to 53%. This technology allows operators to select between short and long chops at short notice and without any changeovers. This in combination with the large choice of KRONE corn conditioners makes BiG X a truly allround machine.

The chop length can be grouped into four different ranges: OptiMaize S, M, L, XL. Each concept describes a different technical solution that leads to customised lengths that suit all applications.



KRONE OptiMaize

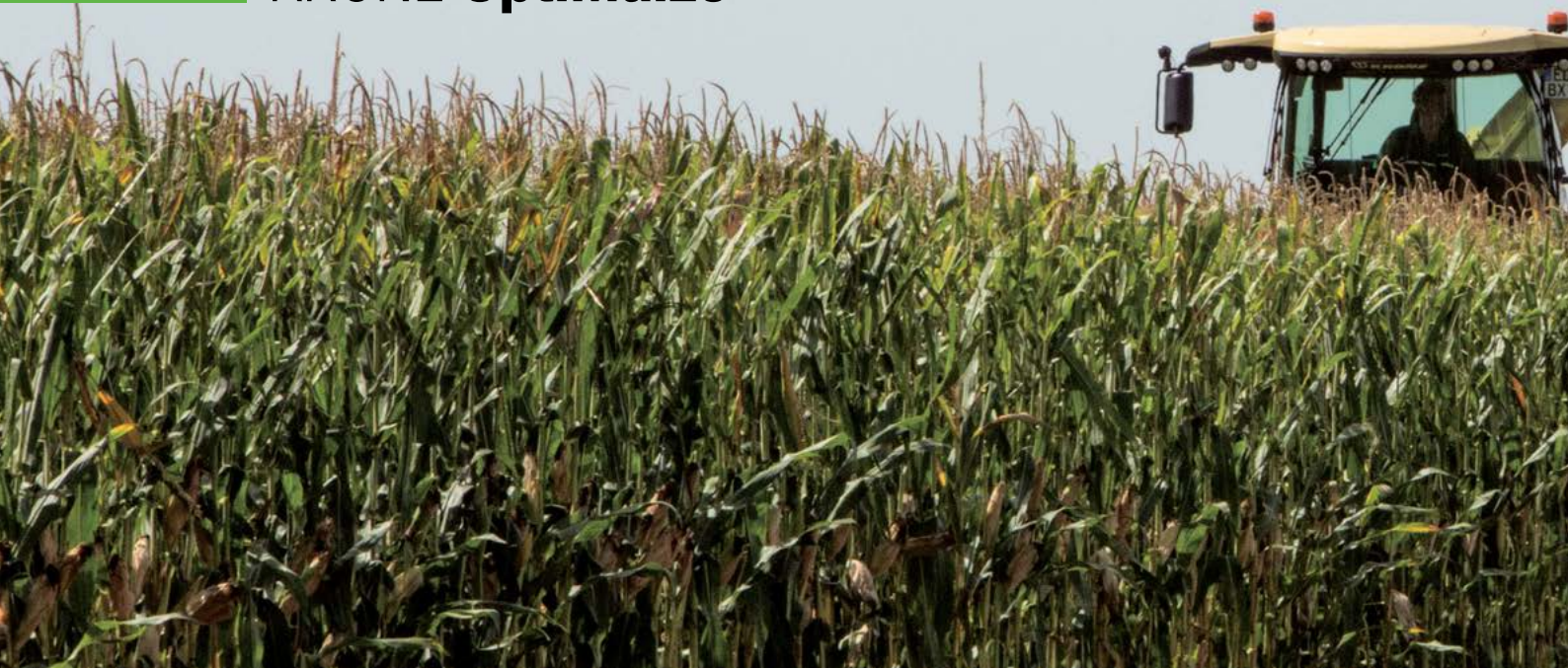

OptiMaize S

Maize that is harvested to fuel biogas plants is chopped to very short lengths. Depending on moisture levels, chops of 4mm to 7mm lengths have been found ideal for this application, because shorter chops make the energy readily available to the methane producing bacteria in the fermenter thereby increasing gas yields.

The KRONE forage harvesters use a Biogas drum with 40 or 48 blades to harvest biogas maize. Alternatively, OptiMaize S results can also be achieved with the 36 blade MaxFlow drum. For good fermentation, the leaves and stalks are subsequently fractured and the kernels destroyed by a KRONE corn conditioner with 123/144 teeth and rotors rotating at a 30% speed difference.

OptiMaize M

Grass based rations for beef bulls and dairy cows which consist of up to 40% of maize should be made up of 8 mm to 10 mm (0.3" to 0.4") chop lengths. This length of cut and an appropriate conditioning intensity avoids lack of fibre in the ration. OptiMaize M chopping quality is achieved by the MaxFlow drums with 36 and 28 blades. The ideal conditioner is the KRONE corn conditioner with 123/144 teeth whose speed differential can be increased from 30% to 40% or 50%.



OptiMaize L

Chop lengths of 11 mm to 19 mm (0.4" to 0.7") are ideal for dairy feed rations where the percentage of maize is about 60%. Rumens require silage maize that is rich in fibres.

The OptiMaize L chopping quality is achieved by the KRONE MaxFlow drums with 28 or 20 blades. The complementary conditioner for these drums is the assembly with 105/123 teeth. The speed differential on these rollers can be increased from 30% to 40% or 50%.

OptiMaize XL

The maize in dairy feed rations made up of more than 80% by maize and that do not contain sufficient quantities of grass and feed straw should be chopped to 20 mm to 30 mm lengths to avoid lack of structure in the feed. The ideal drum for long chops is the MaxFlow drum with 20 blades which is complemented by the KRONE corn conditioner with 105/123 teeth and 30%, 40% or 50% speed differentials. The KRONE disc conditioners offer a 2.5 times larger friction surface area and therefore are the best option for optimum conditioning at maximum outputs.



The **crop flow**

- Six intake rollers ensure a top-notch quality of chops
- High throughput with universal and biogas drums
- Flexible chop lengths through **VariLOC** and the use of only half the number of blades
- Continuous crop flow from **VariStream**
- Variable crop throw is an option using **StreamControl**
- **VariQuick** – quick changeovers between corn and grass

Its innovative technology makes the BIG X a benchmarker in terms of performance and quality. Chopping lengths can be set to individual requirements by adjusting the speeds of the intake rollers and using different numbers of blades on the chopping drum. Highest throughputs are implemented by the spring-loaded floor underneath the drum and a spring-loaded accelerator backplate which guarantee a continuous crop flow.

Chopping drum

- The guarantee for top quality chops
- MaxFlow chopping drums with 20, 28 or 36 blades
- Biogas chopping drum with 40 and 48 blades

Intake system

- Helps achieve the desired chop length
- 6 hydraulic intake rollers
- The speed is set steplessly from the cab

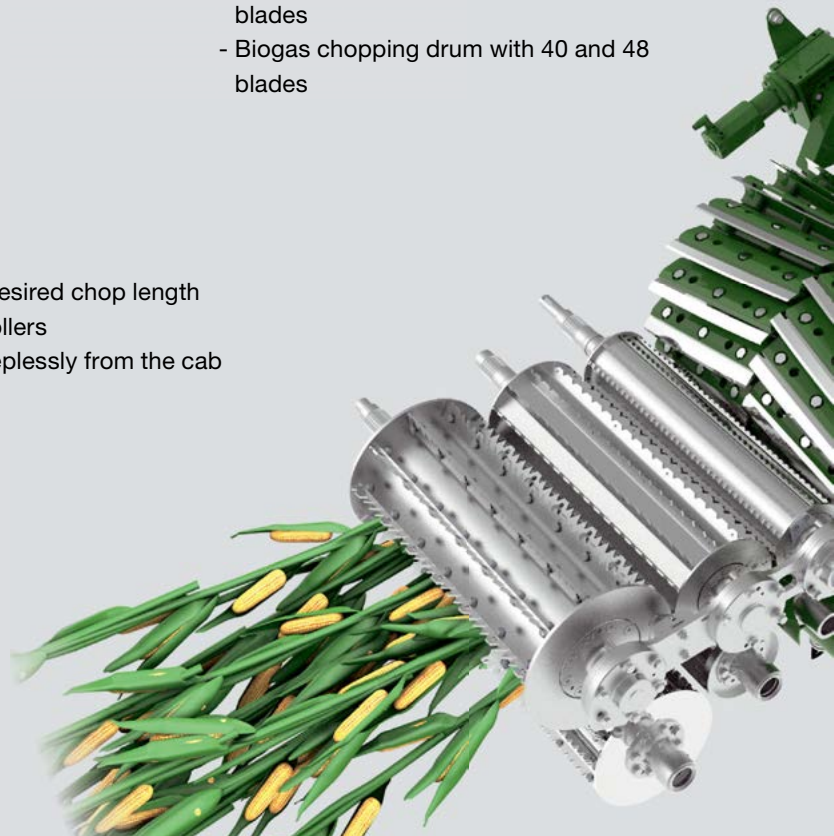



StreamControl

- Powerful crop accelerator
- Adjustable crop throw
- Precision fills of trailers following behind
- Reduced power when filling trailers running alongside
- No losses

VariQuick

Minimum changeover between grass and corn/maize

- Quick changeovers between corn conditioning and harvesting grass
- Removing the corn conditioner is convenient using a lowering mechanism

VariStream

Maximum throughput

- Spring-loaded floor underneath the chopping drum
- Spring-loaded accelerator backplate
- Outstanding chopping quality even in inconsistent crop flows



The intake system

- Hydraulic drive: LOC steplessly adjustable from cab
- 6 pre-compression rollers for a top-quality chops
- Perfect protection from foreign objects which travel a long path from the full-width metal detector to the chopping drum

On a precision forage harvester it is also the intake system that has an influence on the quality of chop. The 6 intake rollers on BiG X compress the material consistently at a high pressure so that it is easier and more precisely to chop. The hydraulic drive of the intake system allows operators to choose between setting the LOC manually or automatically.

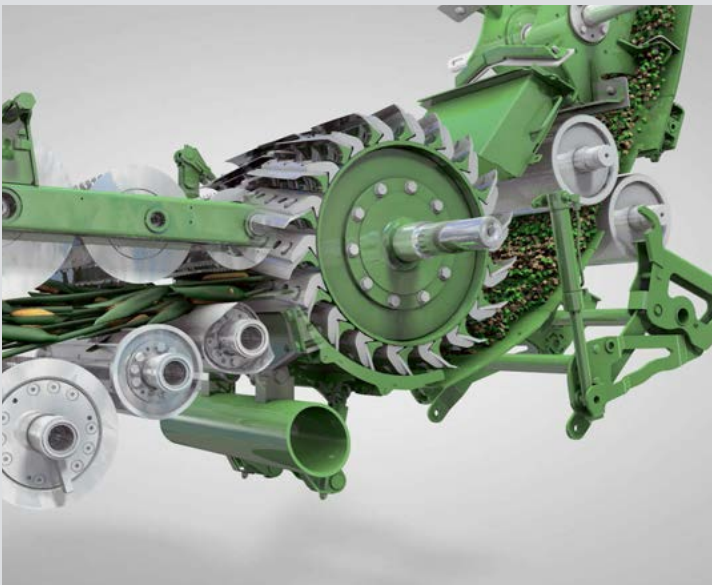

Versatile and flexible

Six pre-compression rollers and an the 820 mm (2'8") gap between the leading roller with metal detector and the counterblade not only enhance pre-compression but also protect the blades better against metal objects, even at high-speed intake. The hydraulic drive in combination with AutoScan adjust the chop length automatically to the maturity of the crop.



Across the full width

The leading bottom rollers are studded with sensors across the full width which detect dependably any metal that is about to enter the machine. The large throat volume makes for highest throughputs. The robust drives cope with the highest strains.



Always under pressure

A system of pushing and pulling springs on the intake rollers combines to give maximum and consistent pre-compression in this area.



Carefully designed

The intake system is placed on a trolley for user-friendly inspection and servicing.



Folding open

Operators can fold the intake assembly forward to gain access to the chopping drum and the counterblade.



The KRONE chopping assembly

- KRONE chopping drums with 20, 28, 36, 40 or 48 blades
- High inertia: enclosed 660 mm (2'2") diameter drums
- Bespoke 800 mm (2'7") wide drums for the BiG X 680, 780, 880 and 1180 models
- Extremely fuel-efficient courtesy of a high inertia and pulling cuts

Matching the drum dimensions to the forager model and choosing the optimum number of blades not only boosts machine power but also makes the forager more flexible to suit more applications. The wide range of OptiMaize drums that are available for BiG X deliver top-quality chops in versatile applications anywhere in the world.



Optimum crop mats

It's not just the number of blades that accounts for a good quality chop. The thickness of the mat that passes through them and therefore the width of the chopping drums are just as important. The 800 mm KRONE MaxFlow and KRONE Biogas drums on the BiG X 680, 780, 880 and 1180 guarantee just that.

OptiMaize chopping drums

Drum type	MaxFlow	MaxFlow	MaxFlow	Biogas	Biogas
No. of blades	20	28	36	40	48
LOC	5 - 31 mm (0.2"-1.2")	4 - 22 mm (0.2"-0.9")	3 - 17 mm (0.1"-0.7")	2.5 - 15 mm (0.1"-0.6")	2 - 12 mm (0.1"-0.5")



The material is pulled over the blades

The blades on the KRONE chopping drums are arranged chevron-style and at an angle of 11° relative to the counterblade. This arrangement makes for a continuous crop flow, extremely quiet running and maximum efficiency.



Kitted out to purpose

BiG X can be fitted with grass or maize blades. Slots on the blades allow for precision adjustment relative to the counterblade and protect the blades against breakage when they hit foreign objects.



Cutting edge

To ensure a good quality cut, the blade and the counterblade must be set to the correct gap. The blades are quick and easy to align using the eccentric plate.



Protected drum body

The carrier bars of the blades have another function besides: they protect the closed drum from wear.



The KRONE **Biogas chopping drum**

- 40- and 48-blade Biogas drums for **OptiMaize S** results
- High cutting frequency, fewer overlengths
- Very economical: high throughput at low consumption
- Short chops for high gas yields

The KRONE Biogas drum with 40 or 48 blades chop the material very intensively. OptiMaize S achieves very short chops which enable high throughputs both on the machine and in the fermenter, making BiG X a major factor in biogas plant productivity.

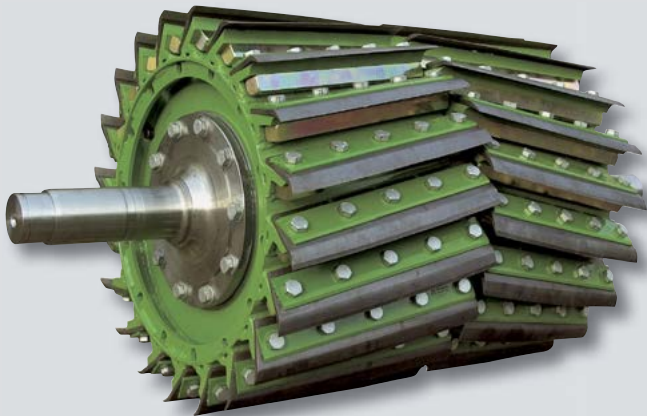

40-blade drum for OptiMaize S

With its higher throughputs and lower fuel consumption per tonne of chopped maize, the 40-blade Biogas cylinder pays for itself in no time. The extremely short chops of 2.5 mm to 15 mm (0.1"-0.6") ferment at a higher rate and increase the gas yield, allowing farmers to produce more biogas from a smaller field.



High frequency of cuts

40 blades can achieve an impressively high cutting frequency. So the Biogas drum cuts harvesting time and increases throughput – even when producing short LOCs.



Standard drum versus Biogas drum

LOC 5 mm (0.2")

Consumption (l/t fresh mass)

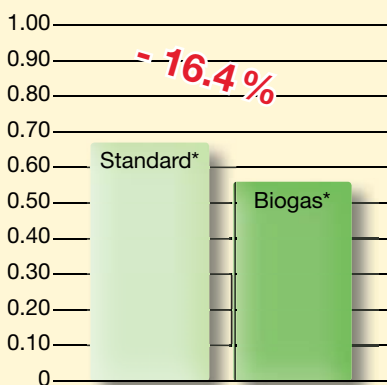

Throughput (t fresh mass/h)

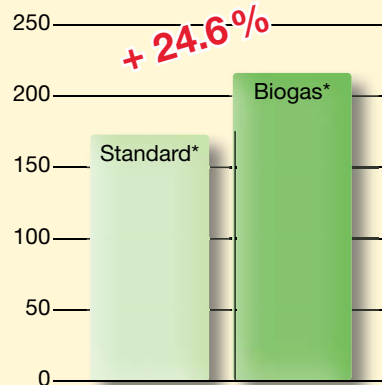

*Standard = 28 blades

*Biogas = 40 blades

More power, lower costs

Chopping the crop to short lengths, the KRONER Biogas drum with 40 blades increases throughput by nearly 25% over what is achieved by a standard 28-blade drum. At the same time, fuel consumption drops by approx. 16% per tonne of chopped material.

48-blade drum for OptiMaize S

Delivering a 20% higher cutting frequency than the 40-blade drum and a theoretical LOC ranging from just 2 to 12 mm (0.1"-0.5"), this Super Biogas drum with 8 blades produces an even shorter chop, Boosting gas yields and throughput at the biogas plant even further and reducing fuel consumption per tonne of crop with the same LOC.





The KRONE **OptiMAXX** roller conditioners

Our roller conditioners redesigned

- **OptiMaxx** roller conditioners with 250 or 305 mm (9" or 1') diameters
- Slanted teeth for perfect conditioning to combine with **OptiMaize S-XL** drums
- The gap between the rollers is conveniently adjusted from the cab
- A strong spring assembly provides a consistent and high pressure
- Maximum fracturing from an up to 50 % speed difference (option)

Every single kernel must be cracked to achieve an optimal digestibility. These user demands are perfectly met by the new OptiMaxx 250/305 roller conditioners with their slanted teeth, a new KRONE development.



Perfect conditioning

The new OptiMaxx roller conditioners have their teeth slanted at a 5° angle. This slant produces a clearly higher shearing effect and perfect conditioning of the crop which receives a very intensive treatment both length- and sideways.

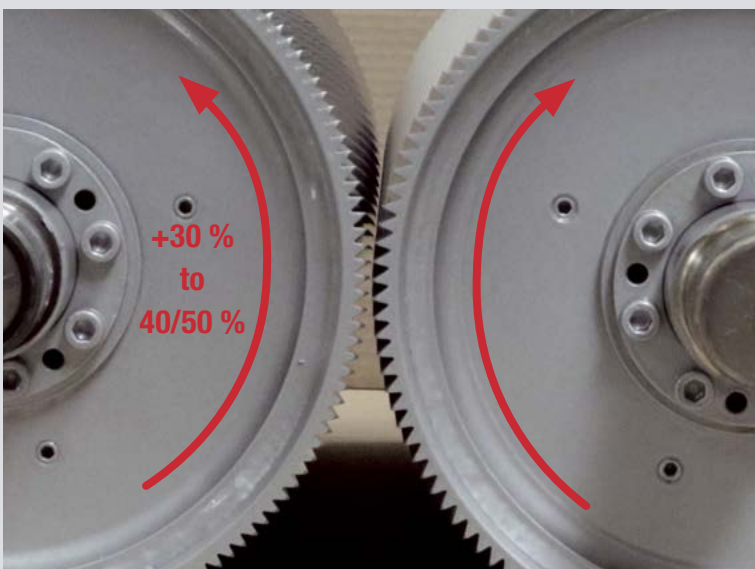

Maximum intensity

The two toothed rollers operate at a 30 % speed difference. This standard difference can now increase to 40-50 % to deliver 100 % conditioning and fracturing of long chops as produced by OptiMaize XL.



Variable roller gap

The gap between the rollers varies between 0.5 mm and 7.0 mm (0.3") and is adjusted steplessly by an electric motor from the cab. The current setting is shown on the display screen.

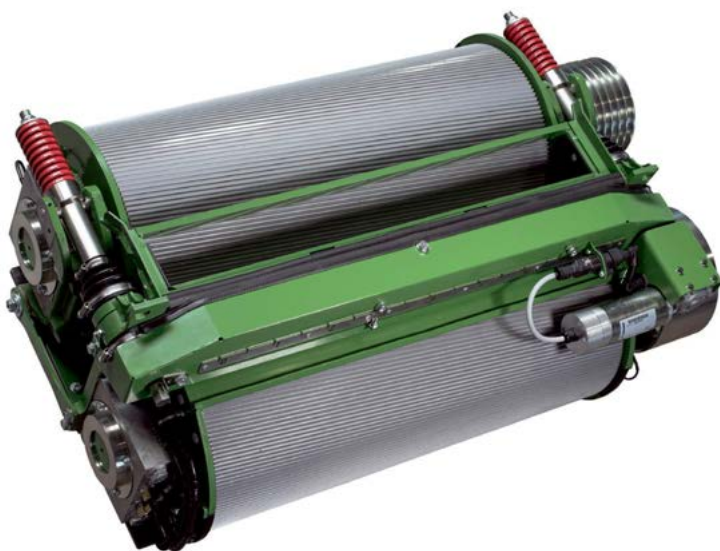

Always plenty of pressure

The two roller conditioners OptiMaxx 250 and 305 (left) are controlled by a massive and powerful spring assembly which applies a consistently high pressure on the crop and hence intensive conditioning to grains and stovers.



The KRONE OptiMAXX roller conditioners

OptiMaxx 250 and 305

OptiMaize S

OptiMaize M

OptiMaxx 250: One for all

With the new OptiMaxx 250, KRONE presents a roller conditioner that offers an even higher performance for the BiG X 680, 780, 880, 1180 models.

This new development stands out for the following features:



- **250 mm diameter** rollers have slanted teeth that give a unique shearing effect
- 10 % longer rotors and a 7 % higher rpm over the previous model. The greater length increases the friction surface area and ensures an effective crop intake, intensive conditioning and optimum cracking results
- **Bigger and stronger springs** apply a consistently high pressure on the crops

- The two rollers in the assembly have different numbers of teeth – 105/123 for medium and long chopping lengths – 123/144 for short and medium chopping lengths
- A standard 30 % speed difference with a 40 % of 50 % differential being an option for intensive fracturing and optimum cracking results

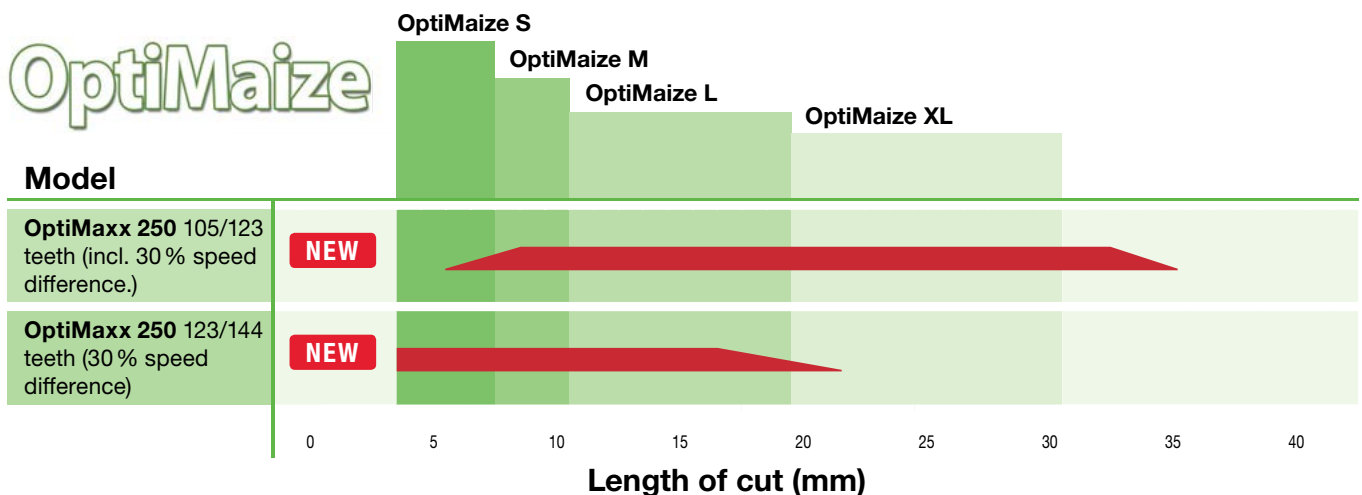



OptiMaize L



OptiMaize XL

OptiMaxx 305: An exclusive for the top model

The OptiMaxx 305 is a unique feature on our flagship, the BiG X 1180.

This roller conditioner has a 55mm larger diameter than the OptiMaxx 250 hence matching the gargantuan appetite of this top-end monster machine.

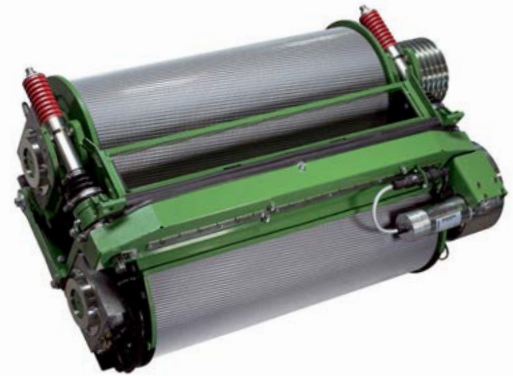

- **305 mm diameter** rollers with oblong teeth give a special shear effect
- A 11 % larger friction surface area and 20 % higher peripheral speed (than OptiMaxx 250) ensure an exemplary crop intake, intensive conditioning and optimum cracking amid high throughputs and long chop lengths.
- **Stronger and more powerful springs** apply a uniform, constant and high pressure on the crops
- A redesigned casing with beefier mountings ensures durability and longevity
- **Temperature sensors** on the roller bearings transmit the data to the operator terminal and ensure maximum safety
- Exemplarily easy to service and maintain thanks to large openings. Bearings, rollers and pulleys are replaced quickly and cleaning is as easy.
- The two rollers in the assembly have different numbers of teeth: – 125/150 for medium and long chopping lengths – 150/175 for short and medium chopping lengths
- A standard 30 % speed difference with a 40 % of 50 % differential being an option for intensive fracturing and optimum cracking results

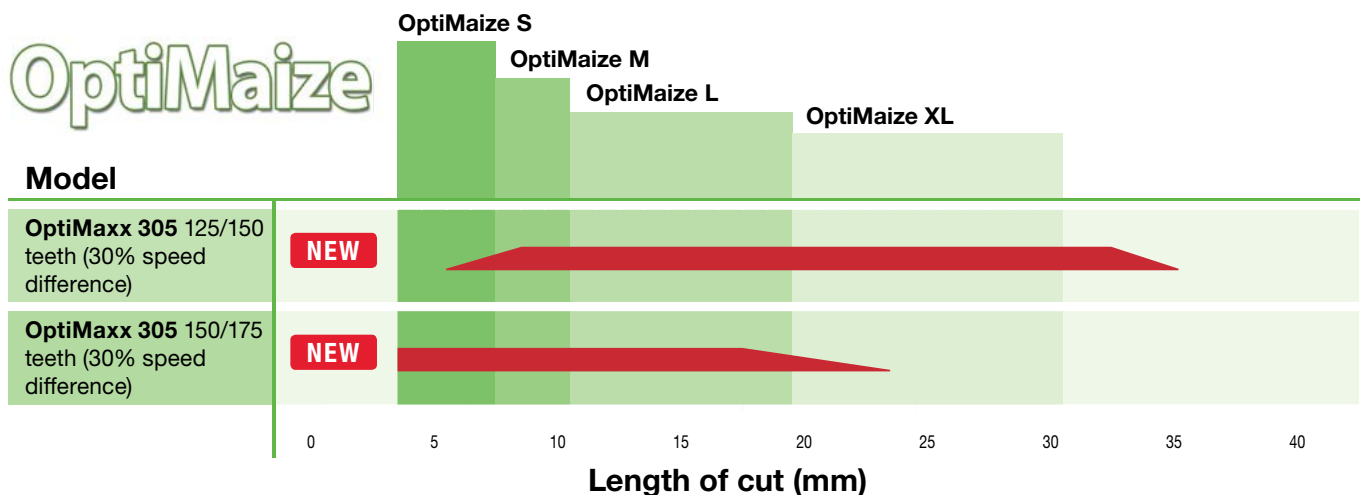



The KRONE **disc conditioner**

- Perfect conditioning and fracturing that preserves structure
- Large 265 mm (10") disc diameter for high output
- 2.5 times larger friction surface area than the roller conditioner
- The gap between the discs is conveniently adjusted from the cab

The KRONE disc conditioner delivers perfect results at a low input power, which is attributed to the special V-form of the discs. This results in a large friction surface area and makes for an enormous throughput and optimally fractured leaves and stalks and thoroughly damaged kernels.



The optimum treatment

The disc conditioner has its teeth arranged so they form V-shaped gaps which increase the friction surface 2.5 times over the friction area on a roller conditioner. This makes for an enormous throughput and optimum conditioning.

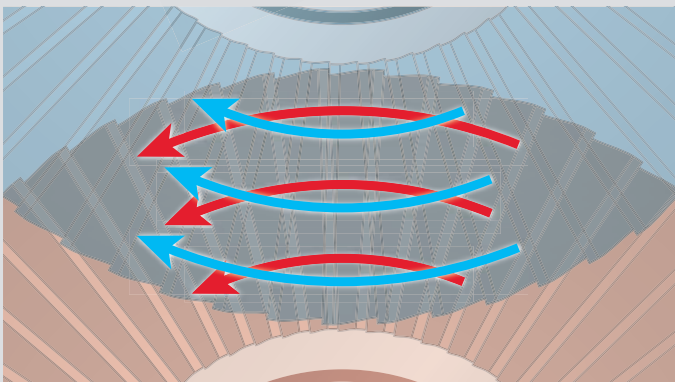

Great friction

With the discs on the outer shaft measuring 265 mm (10") in diameter and those on the inner shaft measuring 135 mm (5"), the discs are rotating towards each other at identical speeds but at different circumference speeds. This results in an enormous frictional effect that not only grinds all kernels but also fractures all stalks - even long chops - in an optimum way.



Variable disc gap

The operator can control the disc gap from the cab, adjusting it steplessly to the current conditions. The current setting is shown on the display screen.

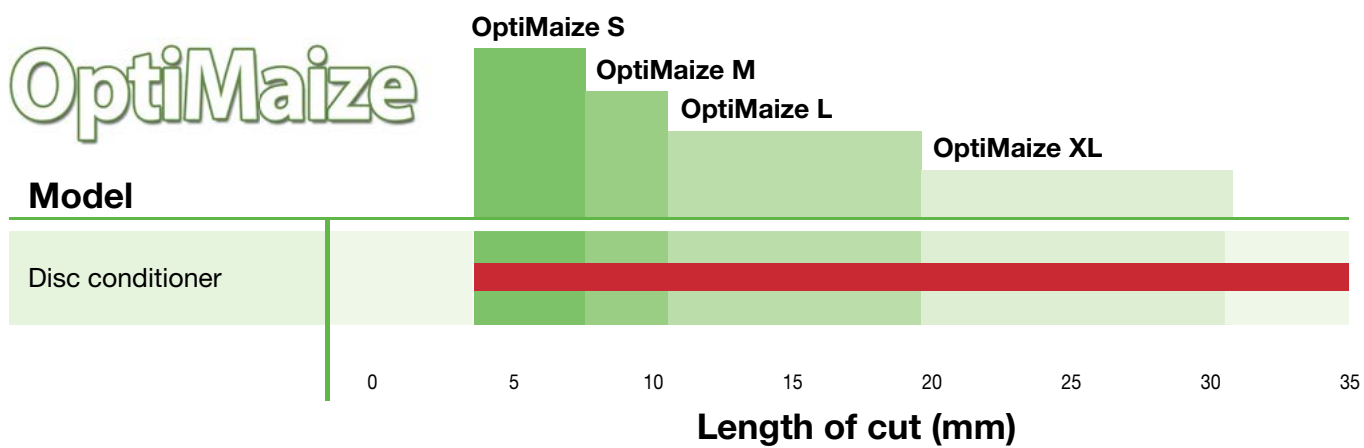

Great flexibility

The gap between the discs can be adjusted to individual requirements to achieve perfect treatment at all chopping lengths – from OptiMaize S to XL.



KRONE VariLOC

- **OptiMaize** is a versatile and unique system
- Gearbox on the chopping drum switches flexibly from short cuts to long cuts
- Switching the drum speed takes only a few minutes
- No downtime, no machine conversion, no up-front planning

Forming an integral part of the pulley, KRONE VariLOC is a gearbox that alters the speed of the chopping drum. By simply changing the drum speed from 1250 to 800 rpm using a standard open-end wrench, you can increase the chopping drum's LOC range by up to 53%. This system allows operators to momentarily change from short to long chops and vice versa and meet different customer needs without a major changeover - this is the concept of OptiMaize. In conjunction with the roller conditioner with 105/123 teeth or with the disc conditioner, this technology turns the BiG X into a real all-round forage harvester that offers its owner and user maximum flexibility.

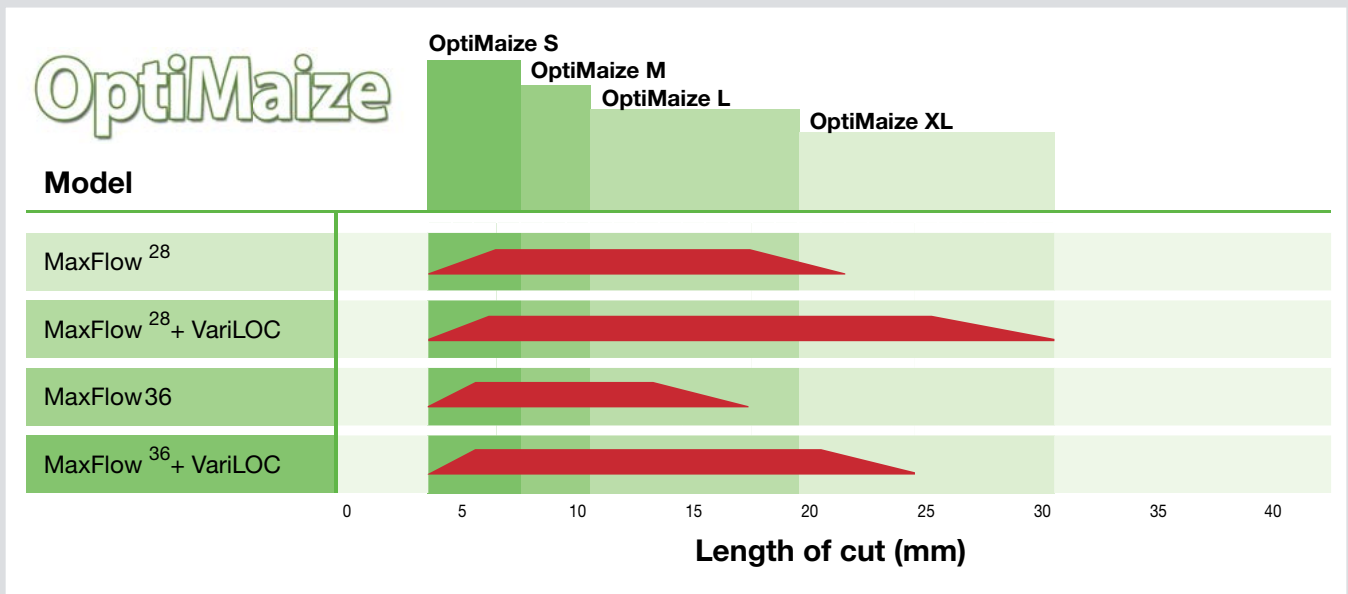

Great flexibility

The KRONE VariLOC is available for the KRONE MaxFlow drums with 28 and 36 blades. VariLOC is a mechanical gearbox that allows the MaxFlow chopping drum to produce the full range of chop lengths (OptiMaize S-XL) with 28 or 36 blades.

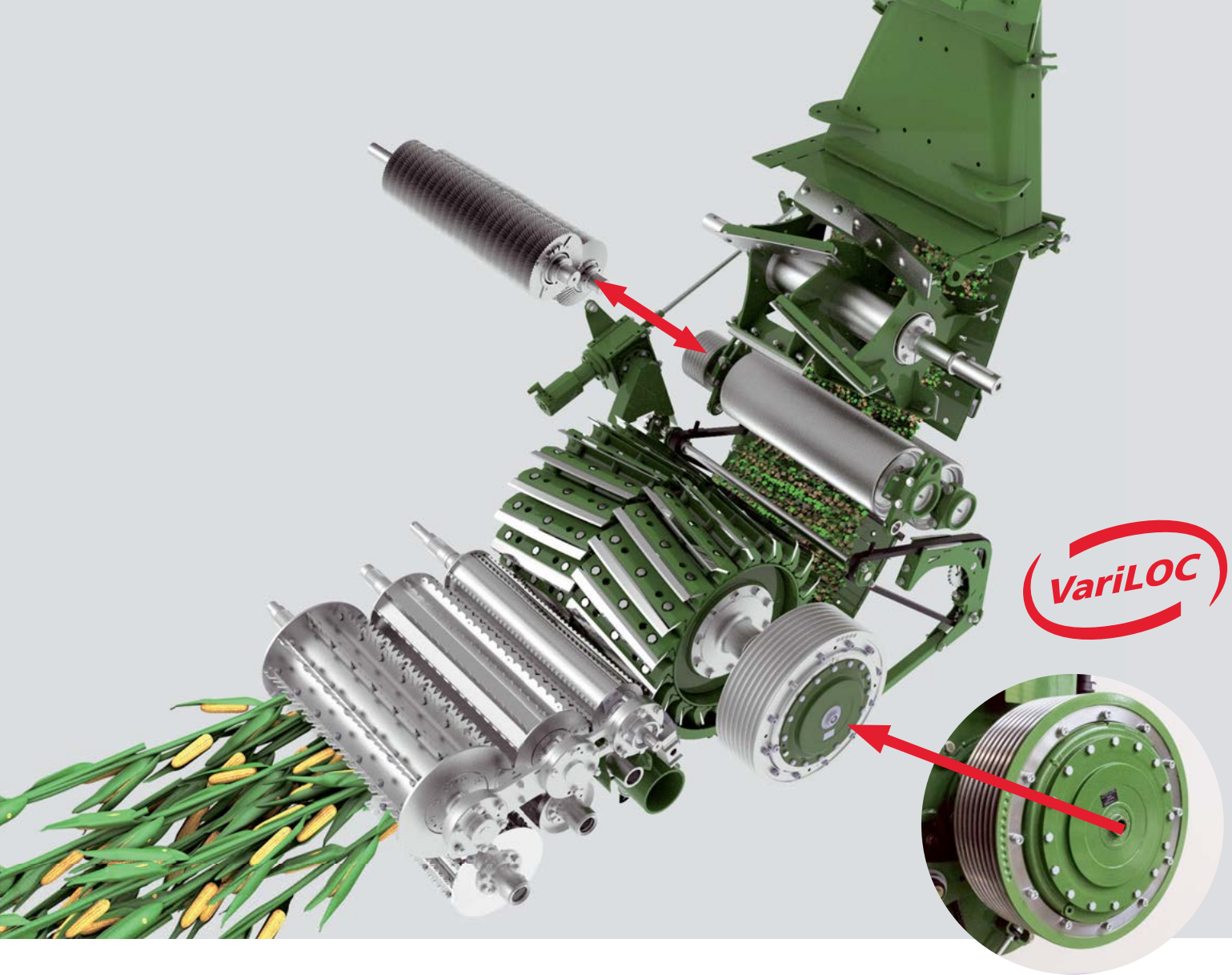

Chop length ranges offered by VariLOC

Chopping drum	min. LOC mm	max. LOC mm	LOC range [mm]	Expanding the LOC range
MaxFlow 28	4 (0.2")	21 (0.8")	17 (0.7")	
MaxFlow 28 with VariLOC	4 (0.2")	30 (1.2")	26 (1.0")	+ 53 %
MaxFlow 36	3 (0.1")	17 (0.7")	14 (0.6")	
MaxFlow 36 with VariLOC	3 (0.1")	24 (0.9")	21 (0.8")	+ 50 %

Wide cutting range

The KRONE VariLOC increases the cutting lengths that are available from the MaxFlow chopping drums with 28 and 36 blades. For the 36-blade drum it increases the range by 50 % from 3-17 mm (0.1"-0.7") to 3-24 mm (0.1"-0.9"). For the 28-blade drum it increases the range even by 53 %, which means from 4-21 mm (0.2"-0.8") to 4-30 mm (0.2"-1.2"). This allows operators to adjust the chop length flexibly as the application changes.



KRONE **VariQuick**

- Fast changeovers from grass to corn conditioning and vice versa
- A chain drive lowers the unit conveniently
- The changeover takes just a few minutes
- Fast and easy removal of the corn conditioner

VariQuick is the system that allows operators to converse BiG X very quickly from maize to grass. A chain drive (electric option) moves the corn conditioner out of or into the crop flow. If the corn conditioner is not used for longer periods of time, you can lower it and remove it from the machine by pulling it out to the side.



Quick changeover

Change from maize to grass or from whole crop silage to grass on the move – either using a chain drive with crank handle or an electric motor as an option. This allows Big X to change from maize to grass or from whole crop silage to grass flexibility and quickly.



Easy to transport

After the transport wheels are fitted without tools, the corn conditioner pulls out to the side and is conveniently rolled to the shed.

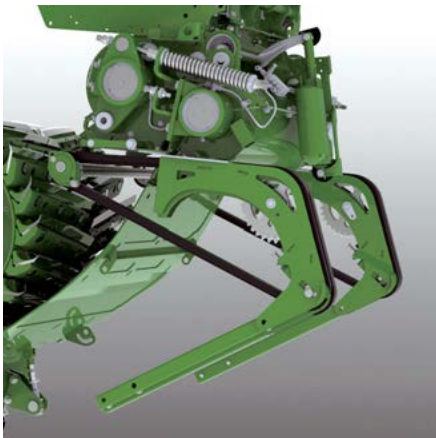

Corn Conditioner in use

In this position, the crop flows through the corn conditioner. This way, the conditioner can subject the kernels to intensive treatment to make the nutrients available.

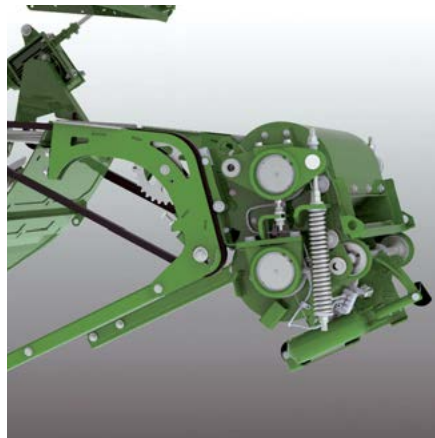

Corn Conditioner in park position

The chain drive moves the corn conditioner out of the crop flow and into its parking position so work can temporarily continue in grass without any major changeover.

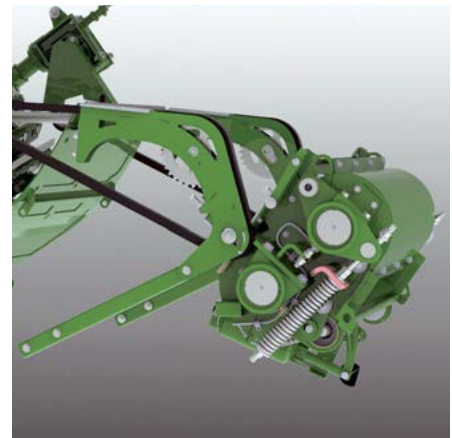

Removing the Corn conditioner

If the corn conditioner is not used for an extended period of time, you can lower it with the help of the chain drive and then remove it.



KRONE VariStream

- Consistently smooth performance despite inconsistent crop flows
- Extremely smooth running – also in lumpy swaths
- High throughputs
- Top quality chop
- Operator comfort to perfection

KRONE VariStream comprises a spring-loaded floor beneath the chopping drum and a spring-loaded back plate in the crop accelerator housing. The system ensures blockage-free and smooth operation, even in varying volumes of crop. The technology allows operators to utilise the forager to its limit and use less fuel per hour.



Springs make the difference

Lumps in uneven swaths absorb operator attention, reduce the overall performance level and can cause blockages. On BiG X, the chopping drum floor and the accelerator back-plate are both spring-loaded to move momentarily out of the crop flow when the volume surges temporarily. The flex-

ible cross section helps reduce the load on the engine and the chopping assemblies, and makes for quieter running and higher outputs.

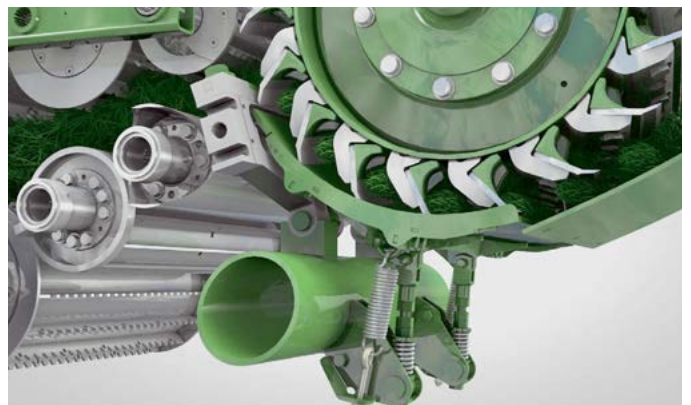

Best quality of chop despite inconsistent crop flows

The spring-loaded chopping drum floor is connected to the anvil of the counterblade at the front. As these are readjusted, the gap between the blades and floor does not change. So any movement of the spring-loaded floor beneath chopping drum in compensation of bigger crop lumps will not affect the quality of chop.



A tight crop stream

The spring-loaded backplate on the crop accelerator ensures maximum throws and targeted fills in all conditions.



KRONE StreamControl

- An adjustable crop throw at the touch of a button from the cab
- Tight crop stream even with a long crop throw
- The shorter the crop throw, the less power is needed
- Fills the trailer accurately without spillage

The crop throw is controlled from the cab by adjusting the door in the backplate on the crop accelerator. This way, operators can adjust the throw quickly to the current filling situation. As the accelerator needs less power to cover a short distance, the operator can free up engine output and use it for chopping and higher throughputs.



Short-distance throws

Filling trailers that are travelling alongside the forager does not require a powerful throw. Instead, in these situations engine output can be freed to boost the chopping capacity.



Long-distance crop throws

With the trailer following behind, the crop stream needs to be ejected from the spout at a higher speed. A strong, tight stream is needed to cover the long distance over the tractor to the trailer.



Crop accelerator

The paddles are designed for high crop output and guide the powerful crop flow towards the middle.



Variable throws

The crop throw is controlled via the hinged flap on the backplate of the accelerator. For a short throw, the flap moves out of the crop flow, so there is little contact between the crop and the accelerator. For a long throw, the flap moves into the crop flow, so there is more contact between the crop and the accelerator.



Stepless electric motor control

The hinged flap on the backplate of the accelerator is adjusted steplessly via an electric servomotor.



Joystick controlled

The throw is quickly changed on the joystick controls.



Armrest control

The additional crop throw control in the armrest offers operator comfort to the max.



The KRONE headers

- Headers are swapped easily
- Convenient attachment and removal
- Very short set-up times
- Compact combination
- Maximum safety

The multi-coupler system of the BiG X allows operators to couple headers fast, easy and dependably from the seat, reducing changeover times when preparing for road travel or different crops. This way, more time is spent on productive work.



Perfect fit

The robust intake system features guide rolls at the top and a supporting base at the bottom with locking pins (hydraulic as an option) which make attachment and removal easy and convenient and give accurate control to the header.



Very adaptable

The header pivots freely to follow the ground contours as it suspends on a hydraulic cylinder on the side of the pivoting base which is made pressureless to give free pivoting.



Easy attachment

The two guide rolls on the base machine trap the curved round steel bracket on the header. Attaching the header to the base machine is as simple as that.



A unique pivoting system

The header pivots laterally on the steel tubes that are trapped in the guide rolls. This type of attachment is easy and straightforward and makes for a large pivoting range.



Convenient

Pins down on the frame lock the header in place. These pins can be operated hydraulically as an option from the seat for convenient header attachment.

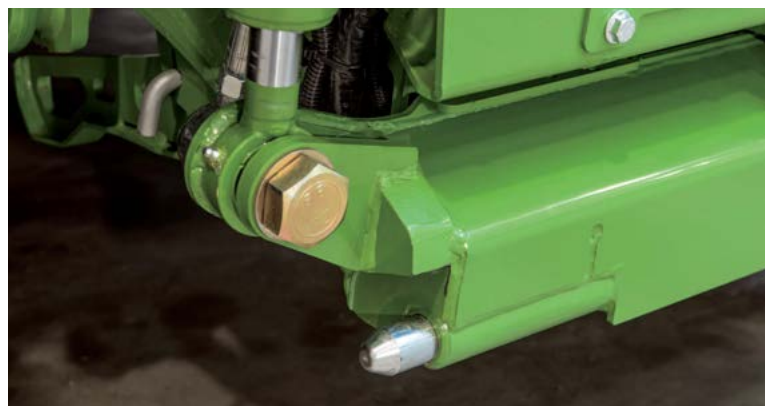

Automatic

The multi-coupler couples the header automatically and reliably. The coupler is spring-loaded as an option. The frictional connection copes with the highest loads.





KRONE EasyFlow 300 S · 380 S

- Hard wearing pick-up without cam track, six rows of tines in W-arrangement
- Automatic pick-up speed adjustment to the current forward speed
- Gauge wheels on the sides and at the rear ensure perfect ground following
- Intake area lined with replaceable wear plates
- Quick header attachment thanks to curved round steel bracket

The camless EasyFlow 300 S and 380 S pick-ups have neither guide rollers nor cam tracks. Compared with conventional pick-ups, EasyFlow has up to 58 % fewer moving parts, which makes it impressively smooth running, low-wear and therefore inexpensive in service and maintenance. EasyFlow operates 30 % faster for cleaner gathering and increased productivity.



Powerful

Working at widths of 3 m and 3.8 m (9'10" and 12'6"), the EasyFlow pick-up on a BIG X gives the machine plenty of intake capacity. Depending on the swath width and your working speed, you can vary EasyFlow rpm steplessly from the cab or have it adjusted automatically to the current forward speed without the operator having to interfere. Its curved round steel bracket gives the header the flexibility to pivot through a large angle and makes for easy attachment and removal.

Going with the flow

Six rows of double tines are arranged in a 'W' for a consistent and clean gathering of the crop even when the swath is not uniform.



Grass head with crop press roller

The standard-fit crop press roller is adjustable for a uniform crop flow also at high ground speeds.



Convenient for operators

When the machine reverses the cross auger and the large crop press roller are raised automatically to give easy access to the intake system so foreign objects that were detected by the metal detector can be removed conveniently. When work is resumed, the press roller and the auger automatically return to their working position.



Adapting all the time

Its stepless height adjustment function and adjustable spring-loaded suspension allows the crop press roller to roll smoothly and adapt easily to varying swath widths.



KRONE EasyFlow 300 S · 380 S



Rapid travel between fields

The unsteered and height-adjustable gauge wheels on the sides move hydraulically into transport position - simply upon a touch of button.



Excellent ground tracking

Two height-adjustable gauge wheels ensure optimum ground contouring on large work widths.



High throughputs

The large, 600 mm diameter auger performs impressively even in dense, over-long crops.



Ultra-durable

Replaceable wear plates increase the service life of the trough in the intake area.



Two settings

The serrated infeed plates can be set to one of two positions to provide different levels of aggressiveness, giving you the flexibility to respond to all conditions.



Strong drives

The drives for the pick-up and the auger are robust enough to handle even the toughest loads. They are fitted with automatic clutches for overload protection.





KRONE BiG X 1180



 **KRONE**
THE POWER OF GREEN





KRONE XDisc 620

- Higher throughput at 6.2 m (20'4") work width
- KRONE **EasyCut** mower technology that is proven the world over
- KRONE **SmartCut** for clean cuts
- Curved round steel bracket for fast attachment and removal and optimal ground following
- Header trailer approved for 40 km/h

Based on the well-proven KRONE EasyCut cutterbar technology, the XDisc direct cutting system allows the BiG X to cut and chop whole crop silage in one operation. which features SmartCut cutting performance and quality and SafeCut impact damage protection.



Harvesting without losses

KRONE XDisc is a versatile direct cut header that cuts whole crop silage cleanly and without losses. The powerful and massive 900 mm diameter feed auger on the XDisc 620 works trouble-free even in dense and tall crops.

SmartCut for stripe-free cuts

As the mower discs turn in both directions, the individual orbits must overlap precisely to ensure a clean cut. For stripeless cuts we have increased blade overlaps on the discs turning outwards. In addition, the blades turning to the rear are now further apart to promote smooth flows of large volumes of crop.

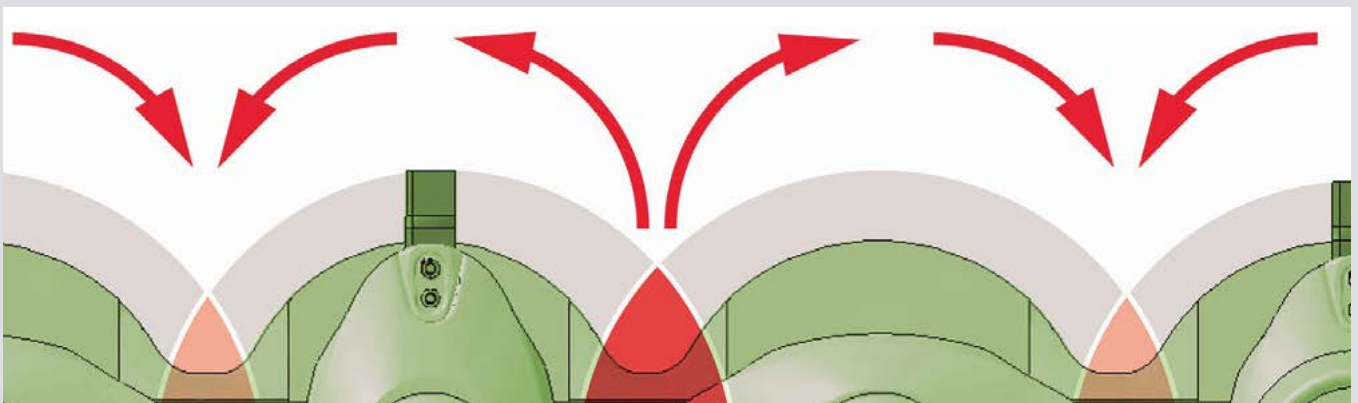



SafeCut is safer

SafeCut centres on a roll pin that connects each disc to the gear and shears off upon impact with a foreign object. As a result the affected discs jacks up on a thread and out of the risk zone. The disc is not lost.



No damage

The SafeCut feature on the disc mower prevents a damaged disc from colliding with the blades on the neighbouring discs preventing damage to the spur gears. The XDisc comes with SafeCut as standard.



KRONE XDisc 620



Changing blades in an instant

Quick-change blades are a must for many farmers and contractors, because this way they can replace blades quickly and easily on the site.



Side knives

The direct cut header can be equipped with side knives as an option. The two knives are driven hydraulically and ensure loss-free harvesting of entangled crops like vetch rye mixes or whole crop silage mixes.



Maximum throughput

The huge 900mm diameter feed auger gives BiG X enormous throughput capacities. The pivoting unit has a reversing mechanism and the auger flights have replaceable Hardox steel wear plates.



The driveline

The cutterbar is driven by an angular gearbox, the auger is driven by a chain. The overrunning clutch inside the cutterbar allows the discs to come gradually to a standstill instead of stopping abruptly when the machine is shut off. The auger features overload protection in the form of a star ratchet.



Fast attachment and removal

Fitting/removing the XDisc is quick and easy. The two guide rolls on the base machine trap the curved round steel bracket on the header. The spring-loaded quick driveline coupler and the hydraulic locking system are options.



Safe and swift road travel

The direct cut header stores quickly and easily on the bespoke trailer with integral braking system for safe travel on public roads.



KRONE EasyCollect

- Variable-row maize headers with 4.5 m to 10.50 m (14'9" to 34'5") working widths
- Best quality of chop, fewer overlength fractions from linear crop feed
- Simple technology and low input power
- The central gearbox

The variable-row EasyCollect header is a versatile unit that feeds the stalks lengthwise into the machine, which translates into an unsurpassed quality of chop. The unique collector principle from KRONE cuts labour costs and has proved its worth time and again the world over.

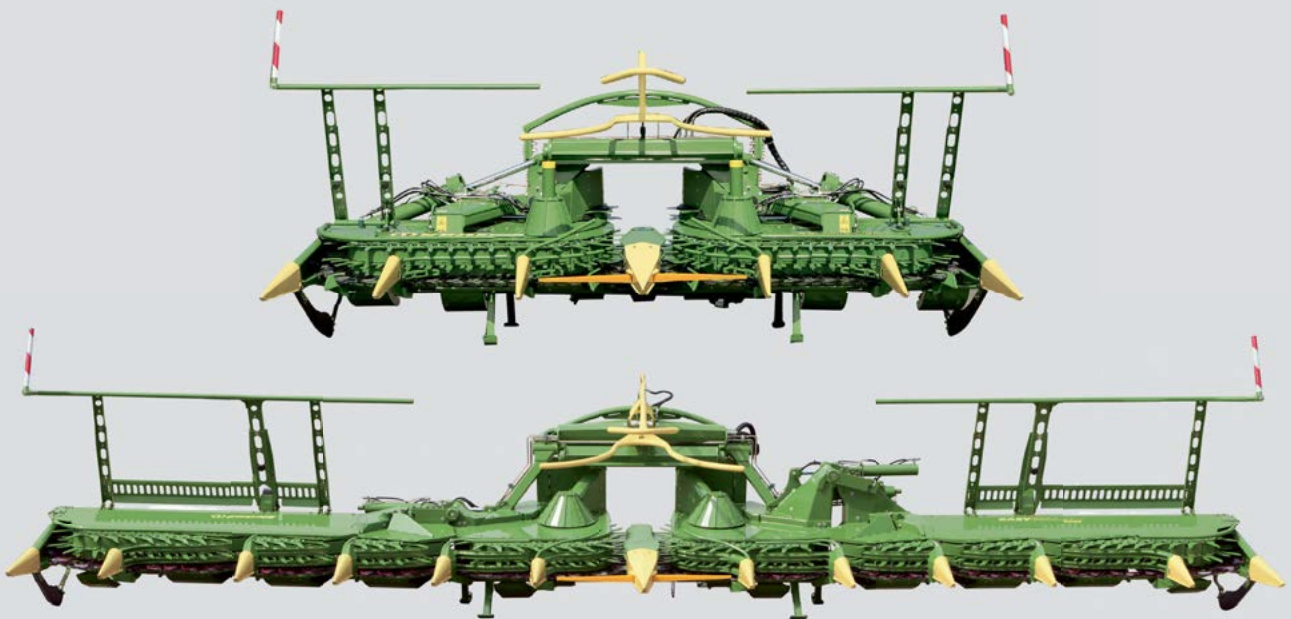

High-power & high-efficiency

Working at widths of up to 10.50 m (34'5"), BiG X features the widest variable-row width header in the world. The endless collectors feed the stalks to the middle where they are turned through 90° and pulled in lengthwise.

Model	Work width	No. of rows	Design
EasyCollect 450-2	4.5 m (14'9")	6	2 sections
EasyCollect 600-2	6.0 m (19'8")	8	2 sections
EasyCollect 600-3	6.0 m (19'8")	8	3 sections
EasyCollect 750-2	7.5 m (24'7")	10	2 sections
EasyCollect 750-3	7.5 m (24'7")	10	3 sections
EasyCollect 900-3	9.0 m (29'6")	12	3 sections
EasyCollect 1050-3	10.5 m (34'5")	14	3 sections



Pulling the crop over the blades

Rigid multi-section blades and endlessly moving blades combine to sever the stalks with scissor-like cuts. The blades are self-sharpening and easy to replace.



Straightforward and good

The 2-piece maize headers stand out for their straightforward design and uncluttered build. Its narrow transport width, its slim design and excellent visibility translate into safe travel between fields.



The central gearbox

The drive power flows efficiently from the central gearbox down auto-coupling driveshafts to the folding collectors.



KRONE EasyCollect



Simply ingenious

EasyCollect maize heads are built to a simple and modular design with endlessly moving collectors. This design leads to a much lighter weight, less maintenance and a long service life.



Clean gathering

EasyCollect gathers the individual rows of maize firmly and feeds them to the middle of the header and into the machine. It is this tidy and lengthwise feed that accounts for the outstanding quality of the chop and for an effective gathering in difficult conditions, such as down maize.



Uniform stubble height

The ground tracers on either end of EasyCollect help maintain a uniform stubble height even in undulating terrain. They signal EasyCollect to follow the set depth in and across the direction of travel.



Optimum crop flow

The crop divider adjusts its height hydraulically to different stalk lengths, so the round steel hoops at the top grab the stalks and pull them into the machine.

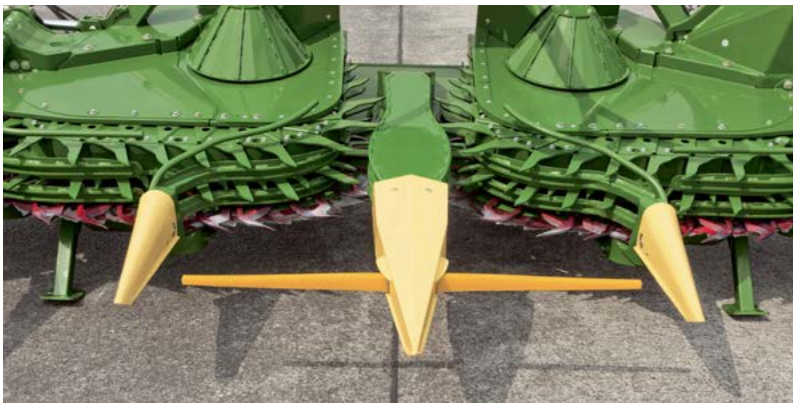

Great stability and excellent tracking

When Autopilot is enabled, the sensor arms on the central cone scan the distance between two crop rows. Then the KRONE BiG X is guided automatically along that row, which helps reduce operator fatigue.



Widest intake system

The dimensions of the EasyCollect intake system match the width of the intake rollers and ensure maximum throughput and top quality chops. The inline flow of the crop and the large intake combine to provide a steady and very tidy crop feed.



KRONE XCollect

The header that uses sickle discs.

- Available work widths are 6 m, 7.5 m and 9 m (9'8", 24'7" and 29'6").
- Variable-row harvesting with rotating sickle discs
- Operates to the collector principle, splits the processes of cutting and feeding
- A smooth and soft cut eliminates vibrations and crop loss
- Operators adjust the cutting frequency infinitely variably to suit the prevailing harvest conditions

KRONE adds new XCollect headers to the long-standing and well-proven EasyCollect series. The XCollect headers split cutting and feeding into two separate processes, responding to customer demands to deal with diverse harvest conditions around the world.



Three work widths

The new XCollect header is available in three work widths:

- 600-3: 6 m (9'8") (8 rows)
- 750-3: 7.5 m (24'7") (10 rows) and
- 900-3: 9 m (29'6") (12 rows)

The three-section headers work to the well-proven EasyCollect collector principle. The XCollect splits the action of cutting and feeding into two separate processes.

The XCollect models

Model	No. of rows	Work width	Transport width	Design
600-3	8	6.00 m (9'8")	3.00 m (9'10")	3 sections
750-3	10	7.50 m (24'7")	3.00 m (9'10")	3 sections
900-3	12	9.00 m (29'6")	3.29 m (10'9")	3 sections



Cutting without counterblade

The stalks are cut by high-rpm sickle discs which rotate on massive bolts that connect them to the driveline. The cut stalks are then fed to the chopping drum by endless collectors which ensure a uniform flow.



The central gearbox

Operators can select one of two speeds to adjust the cutting frequency to the individual crop and harvest conditions.



Compact design

The wings on the three-piece XCollect headers fold up into their transport position. This design leads to a 3 m (9'10") transport width for the XCollect 600-3 and 750-3 and a 3.29 m (10'9") width for the XCollect 900-3 which have optimised hydraulic rams that lift and lower the wings even faster.



KRONE XCollect

One header for all applications

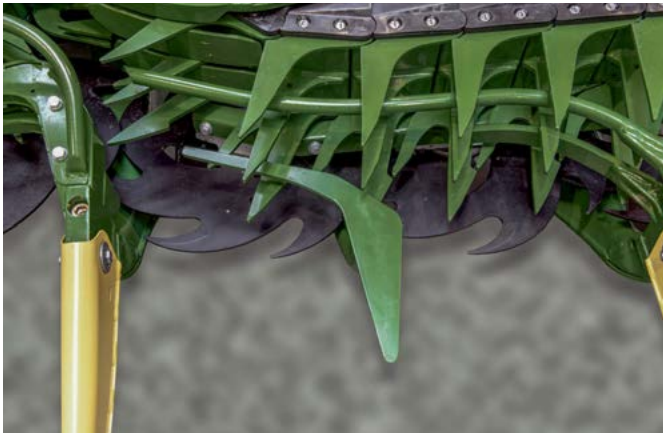

Harvesting without losses

The sickle discs rotate on one plane, cutting the stalks without squeezing them. This technology minimizes vibration avoiding cob loss.



Everything under control

The well-proven collector feeds the stalks lengthwise to the chopping drum. It is this linear crop feed that enables precision chops and minimum overlengths. The variable collector speed is standard and ensures a consistently high quality of chop.



Fractured stubble

The high-speed sickle discs cut the stalks and defibrate the stubble for optimum breakdown.



Hovering over the ground

The header has three sensor skids, one in the middle and two out on the ends, for optimum contouring and clean cuts in undulating fields and for clean forage.



Protected driveline

Star ratchet clutches protect the sickle disc driveline from overload. Speed sensors scan the speeds of two discs and send potential overload information to the operator terminal. In addition to this, a friction lining on each disc offers additional protection.



Maximum ride comfort

A fully integral and hydraulic transport chassis is available as an option. The advantage of this is that it takes weight off the front axle, enhances operator comfort and makes homologation easier. This chassis is not removed from the base machine and not parked separately in the field but is simply raised out of work.





The engines

- 8- or 12-cylinder V-engines from Liebherr
- Compact V design for transverse mounting
- Final Tier 4 / Stage 4 or 5 compliant
- 687-1156 hp maximum continuous engine power
- High efficiency and quiet running

Advanced Common-Rail engine technology from Liebherr suggests superior outputs and fuel economy. The engines stand out for optimum torques, quiet running, superb fuel economy and high efficiencies.

Model	Engine			Engine capacity in litres	Engine Sustained output in kW/hp	Sustained engine output during chopping in kW/hp	Sustained engine output during chopping in kW/hp
	Model	Emission standard	Design			X Power	Eco-Power
BiG X 680	LIEBHERR D 9508	Stage IV Final Tier 4	V8	16.16	505 / 687	487 / 662	368 / 500
BiG X 680	LIEBHERR D 9508	not regulated >560 kW*	V8	16.16	505 / 687	487 / 662	368 / 500
BiG X 780	LIEBHERR D 9508	Stage IV / Final Tier 4	V8	16.16	570 / 775	550 / 748	401 / 545
BiG X 780	LIEBHERR D 9508	not regulated >560 kW*	V8	16.16	570 / 775	550 / 748	401 / 545
BiG X 880	LIEBHERR D 9508	Stage IV / Final Tier 4	V8	16.16	660 / 898	632 / 860	459 / 624
NEW BiG X 1180	LIEBHERR D 9512	Stage IV / Final Tier 4	V12	24.24	850 / 1156	818 / 1112	515 / 700

*In Europe BiG X 680 and 780 are exempted from emission regulations on account of their high engine power which is certified at 560kW.



Liebherr D 9508 - V8



Liebherr D 9512 - V12

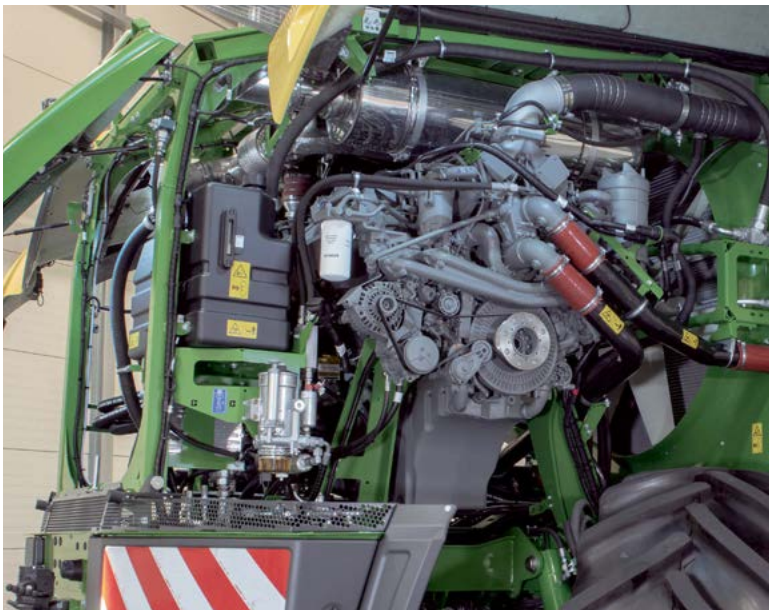

All-out efficiency

The engine is mounted sideways for optimum weight distribution. The power flows from the engine down a powerbelt and directly to the chopping and feeding components - a setup that ensures maximum efficiency.

Engine output

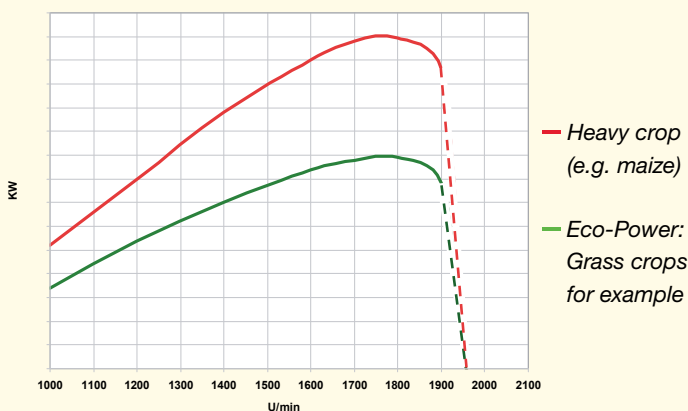

As much power as necessary

KRONE PowerSplit controls the continuous engine output and matches it automatically to the current harvest conditions. Eco-Power is selected when less machine output is needed whereas X-Power is the right choice when heavy going calls for maximum output. The PowerSplit feature gives BIG X great flexibility and reduces fuel consumption significantly.





The driveline

- Simple design
- An extra-strong poly V-belt transmits engine power to the crop assemblies
- Long service life
- Separate drive for the intake rollers and the headers: Rollers and headers are reversible if the chopping drum suddenly stops
- Separate and dependable driveline to the ground drive pump

The transversely mounted engine allows the chopping drum and the crop accelerator to take engine power directly off a powerbelt. The engine also drives the pumps for the intake rollers and the header and also the pump for the ground drive and the assemblies. The power flows through a power take-off gearbox which uses a multi-plate clutch to engage the assemblies.

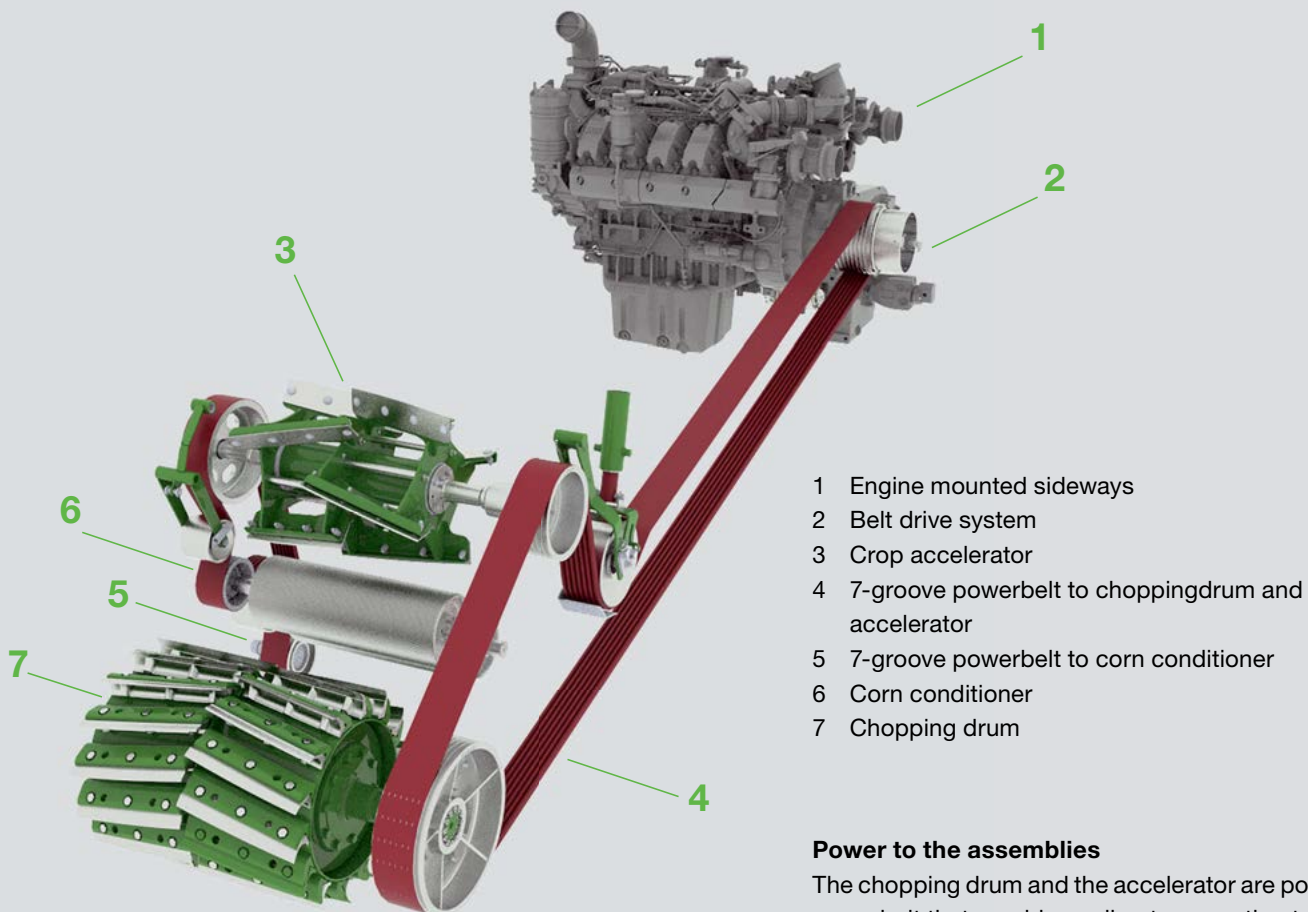

Power to the assemblies

The chopping drum and the accelerator are powered by a powerbelt that provides a direct connection to the transversely mounted engine. The accelerator shaft drives the poly V-belt for the corn conditioner on the other side. Slackening the powerbelt to the chopping drum reverses the intake system and the header.

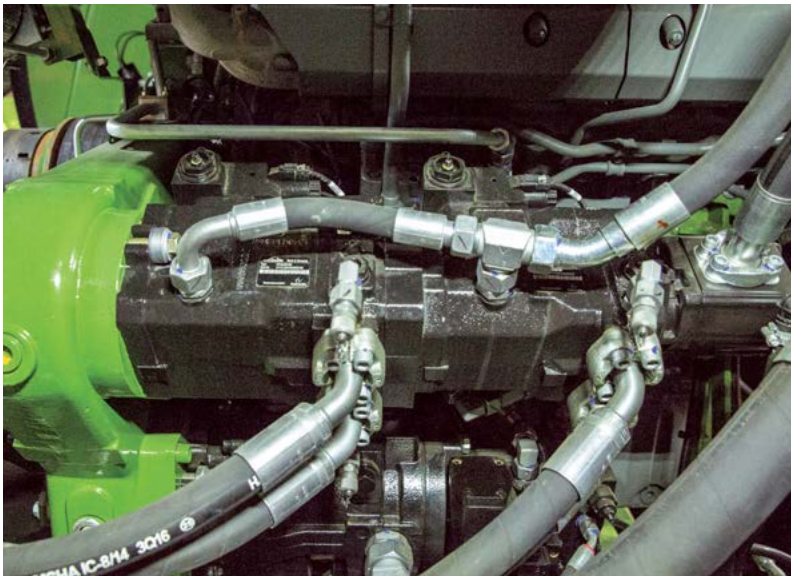

Carefully designed

The header and intake system are driven by oil pumps. This concept allows operators to adjust the header and intake speeds steplessly - ideal for adjusting automatically to varying harvesting conditions.

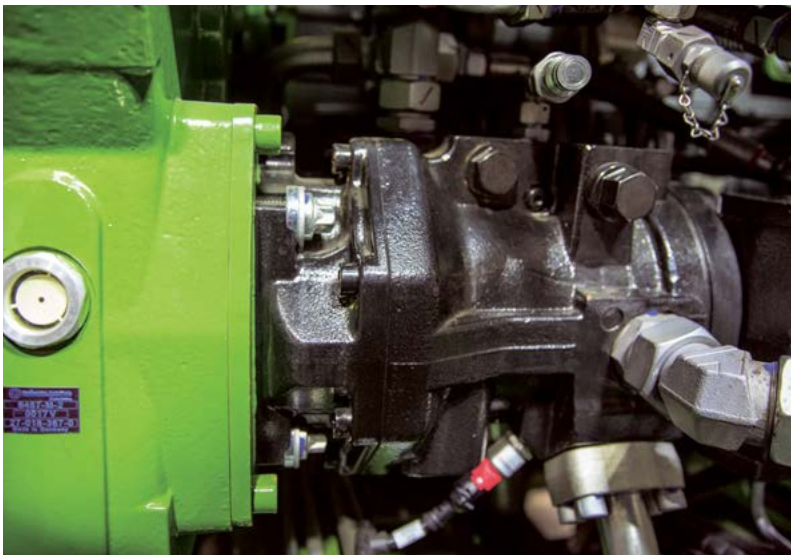

Optimum ground drive

Courtesy of a hydro pump that is flange-mounted on the main gearbox, Big X changes its ground speed infinitely variably. This is set either automatically or manually from the cab. The dependable powertrain guarantees maximum reliability.



The **running gear**

- Front-wheel drive is standard; four-wheel drive is an option
- Powerful wheel motors from Bosch-Rexroth
- Traction control with three travel modes
- High ground clearance powertrain

Wheel motors offer greater productivity and a higher level of automation and operator convenience. At the same time, this type of power train reduces maintenance and frees valuable space to fit a bigger and more powerful chopping assembly and move this further to the rear of the machine.



4WD

BiG X 680/780/880 are available with hydraulic wheel motors on all four wheels as an option.



Front-wheel drive

All BiG X machines have front-wheel drive as standard specification and have the wheel motors on the rear axle replaced by hubs.



Planetary gearbox

The wheel drives are planetary gearboxes from Bosch-Rexroth. These offer the advantage of distributing the load to several planetary wheels which are compact and enable high torques.



Good build

The use of hydraulic wheel motors results in a very generous ground clearance and frees room for a larger diameter chopping drum and also leads to a more even weight distribution.

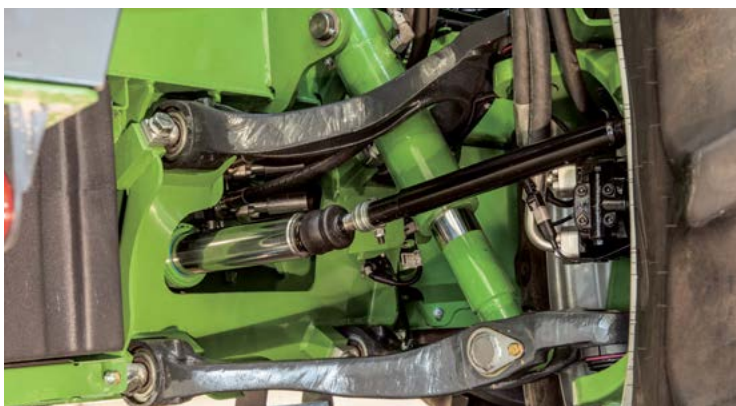

Cushioned road travel

The steered axle on the BiG X comes with spring suspension as standard to ensure maximum operator comfort – both in the field and on the road.



Traction control with three travel modes

The operator decides which of the three travel modes to use. The mode that reduces wheel slip is usually selected when the focus is on protecting the sward. Maize foraging usually takes place in a mode that tolerates a higher wheel slip or even with traction control deactivated.



The **running gear**

- Superb manoeuvrability from independent wheel suspension and wheel motors
- Sprung steering axle
- Height adjustable wheel motors
- Large choice of tyre options

Its hydrostatic wheel drive, its independent wheel suspension and its compact build make BiG X a tremendously agile machine that gets into every corner and turns elegantly on tight headlands, saving turnaround times and increasing productivity.

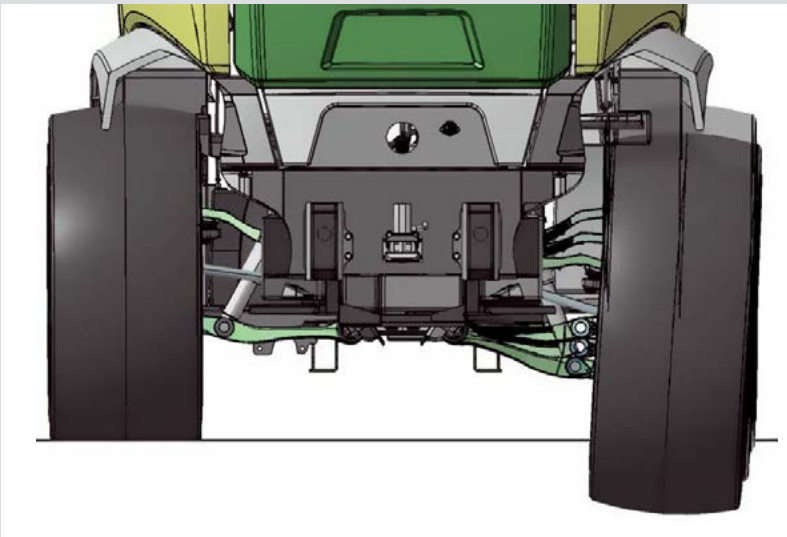

Great manoeuvrability from independent wheel suspension

The independent wheel suspension system offers plenty of room for steering so that even when clad with massive tyres BiG X remains a very nimble machine in undulating terrain. In addition, the suspended system provides maximum operator comfort.



Height adjustable wheel motors

The wheel motors are mounted eccentrically on the front axle which allows you to fit small or large tyres and still retain the position of the pick-up, the intake system and chopping drum floor relative to the downstream crop flow. This detail warrants an optimum and consistent crop flow and increase ground clearance.



Extremely agile

Using wheel motors increases the steering angle to a generous 50° for tightest turns and perfect match-ups after headland turns



Tyres with a purpose

There is a choice of tyres available for BiG X. Large tyres offer plenty of ground clearance and reduce compaction. The BiG X 680, 780 and 880 can be fitted with up to 900/60 R 42 front tyres.



Kitted out perfectly

- LED lights for best visibility at night
- Optimum access to all service points
- Large storage compartment for tools
- Auto lubricator for more convenience

In the heat of harvest operators often work into the night. To ensure best visibility BiG X is equipped with a comprehensive light kit that turns night into day. Service and maintenance are made easy too thanks to wide opening side panels, an opening engine compartment cover, removable plastic mudguards and a ladder that swings out of the way to give easy access to all service points.



Day and night

BiG X can take up to 23 LED work lights which make field work safe and effective even during those night shifts.



Moving the ladder out of the way

The access to the cab is easily moved out of the way to give convenient access to all nearside service points.



Illuminated access steps

LED lights on the steps make access to the cab at night a safe climb.



Automatic lubrication

The auto lubricator and its large grease reservoir allow operators to spend less time servicing and maintaining the machine.



Perfect access

The hoods open wide and the rear mudguards give perfect access to all assemblies. LEDs are in place for easy service and maintenance even in poor light conditions.



Plenty of room

The space between the radiator screen and backplate of the crop accelerator provides excellent access to all elements in the crop flow system.



Useful storage space

The nearside storage compartment at the rear boasts a pivoting table which accommodates the toolbox for convenient use.



Easy to get at

The batteries are stored in the storage space on the right side of the machine where they are in easy access.



The KRONE multiple tank concept

- Seven different tank systems are available for maximum flexibility
- Customers can opt for more fuel or more silage additives
- Integral silage additive applicator with small/large dose rates as an option
- Maximum fill capacities for long working days

A system of several tanks allows customers to specify the reservoirs on the machine to their needs – fuel, silage additive and water tanks can be added and configured in as many as seven different arrangements that meet individual needs around the world.

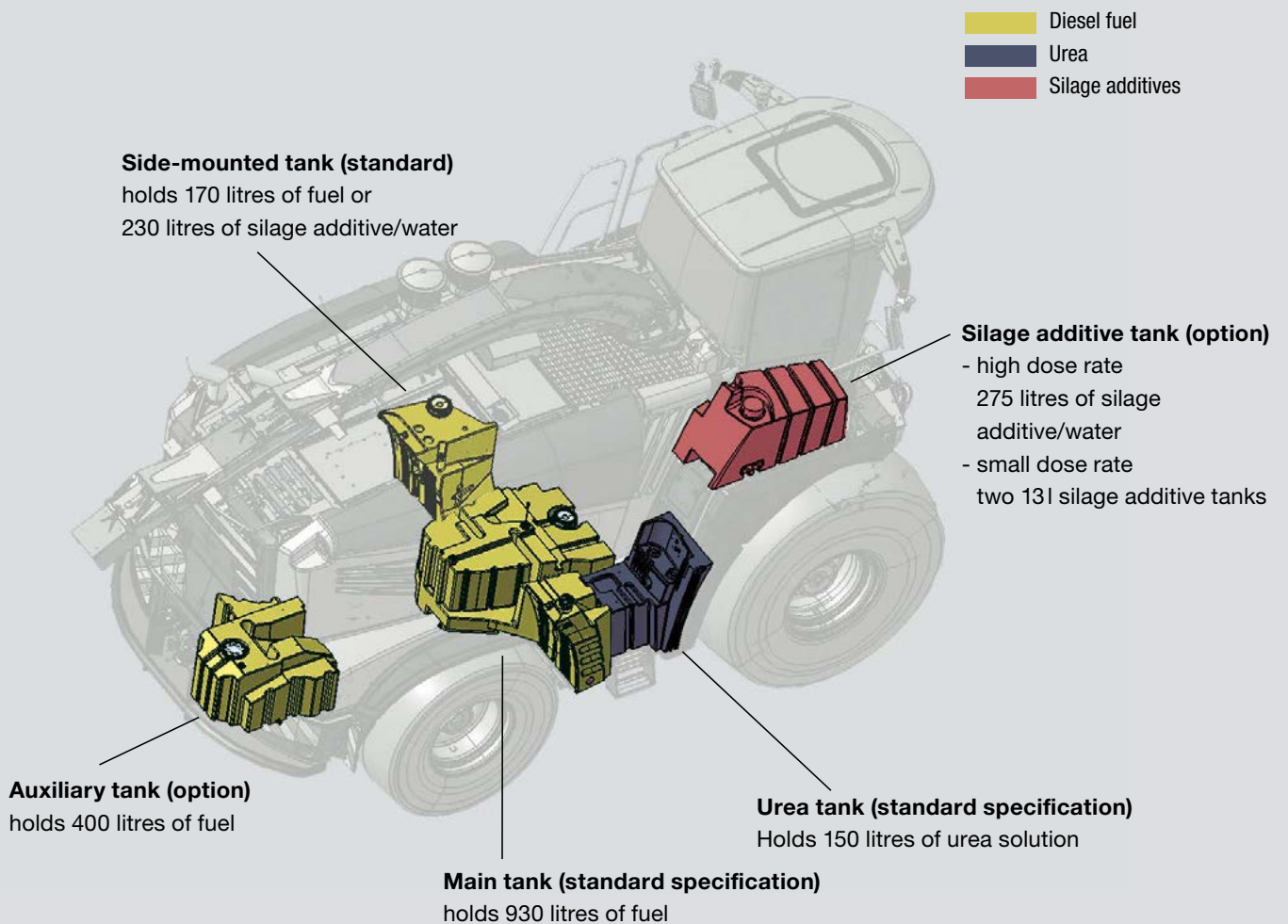



Storing enough liquid

For example you can add a 150l urea solution tank to the 1,500l or 1,100l diesel fuel tank and a 275l or 505l silage additive unit. BiG X features a flexible system of tanks that offers customised solutions for individual machine applications.



Silage additive options

The dispenser for adding silage additives at high rates (0.5-7.5l/min) is integrated on the offside platform next to the cab. You can also use the nearside tank to store silage additives and increase the on-board volume to 505l.

Two 13-litre silage additive dispenser for small dose rates (0.03-0.25l/min) can be integrated in the right wheel housing. In addition, it is possible to fit an external silage additive system. The silage additive can also be added relative to yields (option).



The **cab**

- Extremely spacious and quiet
- Maximum seating and operator comfort
- 360° panoramic view
- Optimum visibility from the raised cab (option)

It takes a comfortable working place to stay fit and alert during those long working days. The spacious Silent Space cab offers such an ideal environment. Providing generous space to the operator and a passenger, it provides a fully air-conditioning and an absolutely functional working place. The unique CabLift offers an unprecedented panoramic view from a height of up to 70 cm (2'4").



Wider, quieter and brighter

The wide and slim posted cab offers plenty of space and best view of the headers with wide working widths. The floor is insulated twice for reduced noise levels in the cab. Sixteen H9 lights provide perfect illumination. A package of 23 LED work lights is available as an option.



Panoramic view

High side windows and slim posts give the operator an unobstructed view of all processes.



Sun blinds

Sun blinds are available for the side and rear windows to protect you from the sun and heat.



Perfect visibility

Now matter the conditions – rain or dust – BiG X operators always enjoy a clear view thanks to three optional wipers on the front window, two on the side windows and one on the rear window. All wipers have water jets.



Clear concept

The heating system and the air conditioning are operated from the terminal above the front window. The Follow-Home function lights your way as you get down from the cab. After you shut off the engine some headlights stay switched on for several minutes, allowing you to find your way safely.



The cockpit

All controls including the joystick, the screens and the terminals are designed to ergonomic standards and in easy reach from the operator seat.

Ergonomic and convenient

The joystick feels pleasant in driver's hand. With more than 20 functions programmed to it, the stick not only controls ground speed and direction of travel but also the header and spout.



Keeping you informed

The big 12-inch terminal with USB drive and a video input records all the machine data and displays them on the high-definition colour screen. The screen can show the footage from the reverse drive camera and the camera on the spout.



The KRONE **LiftCab**



Superb visibility

If the BiG X is specified with a LiftCab, it will be possible to raise the complete cab to any height up 70 cm. From the raised position operators enjoy a full overview of the tall stands and can easily monitor the filling processes. As another advantage, the raised cab increases the distance between the operator and the chopping assemblies thereby reducing the noise level at operator's ear.



A scissor lift for the cab

The cab is mounted on a scissor lift which raises and lowers the cabin to any position – infinitely variably and within a few seconds. The area under the cab floor is shielded to prevent ingress of dirt and debris.



At the touch of a button

The CabLift is activated from the seat at the touch of a button and is then raised hydraulically to the desired height.



Less operator stress - more peace of mind

Harvesting high-yielding maize crops, forager operators often are driving up towards an up to 4m high wall of crop all day. The cab lift allows them to raise their seating position and enjoy a clear view of the field, reducing fatigue and helping them concentrate on the machine and spot any hazardous situations more easily.



Everything in control

High-sided trailers can be a problem for the forager operator who has to determine when the trailer is filled to capacity. In this situation, raising the cab by 70cm is a big help. Whether the trailer is travelling alongside or behind the forager, the operator has always a clear view of the load area and can ensure optimum fills.



Operator Assist Systems

- **AutoScan** enables operators to adapt the LOC relative to the current maturity of the crop
- **ConstantPower** ensures optimum fuel economy at maximum throughput
- **EasyLoad** supports operators in filling the harvest fleet trailers to capacity
- **RockProtect** protects the forager from damage by stones

KRONE offers a range of different systems which help utilise our BiG X forage harvesters to their full potential and ease the strain on the operator. The electronic assist systems supply relevant data on the crop and provide reliable information in extremely difficult positions.



Chopping as short as necessary

A photo-optical sensor in the middle of the maize header measures the maturity of the plant and automatically adjusts the length of cut. Green maize is cut to longer chops to get more structure and reduce effluent in the clamp. By comparison, dry and brittle maize is cut to short chops to increase compaction. This way, AutoScan eases the load on the operator and reduces fuel consumption by optimizing the length of cut.



Lift speed

After the operator selects the desired engine load, ConstantPower automatically matches the forward speed to the current stand and yields, easing the strain on the operator and improving fuel economy at maximum throughput. In combination with AutoScan, the system takes the overall quality of chop and machine performance to a whole new level.



More eyes watching

The EasyLoad auto loading system in combination with a camera-based 3D image analysis system allows operators to fill any type of trailer that is running alongside the harvester. The system controls the open/close spout and the rotate left/right functions and allows operators to select one of several filling strategies. Monitoring all functions from the in-cab screen, operators are more at ease.



Intelligent precaution

The optional RockProtect system provides intelligent protection from damage by stones as it fully automatically halts the pre-compression rollers within milliseconds after a stone is detected. The sensitivity of the system is set by the operator.



Operator Assist Systems

- ISOBUS steering system for auto guidance
- **CropControl** for accurate yield metering
- **AgriNIR** online sensors measures moisture and nutrients on the move
- AutoCalibrate calibrates the BIG X yield metering system in the field

The ISOBUS steering system guides the machine automatically along the preset way line. Further systems are available to measure and log the harvested weight by field and moisture levels.



Auto guidance

Every BiG X machine is ready to accept various ISOBUS guidance system brands. On the move, the operator activates autoguidance from the KRONE joystick.



Measuring yields per field

The optional KRONE CropControl yield metering system measures the volume of crop harvested per field quickly and accurately at the touch of a button. The system allows operators to document meticulously all yield information in all fields harvested.



Automatic counterblade adjustment

As an option it is possible to adjust the counterblade automatically and from the cab. Based on a knock sensor that measures the gap between the counterblade and the chopping blades and a rotary encoder that triggers two motors that adjust the counterblade, the system reduces operator stress as he or she can concentrate on the work at hand. At the same time, it is also possible to adjust the counterblade manually from the external control unit.



Metering moisture and nutrient levels

The optional AgriNIR online sensor supplies accurate data on moisture and nutrient levels on the move. This information (DM, starch, crude protein, crude ash, crude fat, ADF, NDF) is collected to and allocated to the harvested field by the KRONE operator terminal. The AgriNIR online sensor is easy to install on the BiG X spout where it is protected from damage by a cover.



Convenient weighing

AutoCalibrate is the remote calibration tool for the BiG X's yield metering system. It operates via a weighing system installed on one of the trailers in the harvest chain. Both the trailer and the forager are equipped with data loggers that communicate via a mobile network. Calibration takes place in real time as the 'calibrating machine' is being filled. The system is highly accurate and is the first system of its kind to eliminate the trip to the weighbridge.



Technical data

NEW

		BiG X 680	BiG X 780	BiG X 880	BiG X 1180
Engine					
Model number		Liebherr D 9508	Liebherr D 9508	Liebherr D 9508	Liebherr D 9512
No. of cylinders		8	8	8	12
Engine capacity	Litres	16.16	16.16	16.16	24.24
Sustained engine power	kW/hp	505 / 687	570 / 775	660 / 898	850 / 1156
*** Max. continuous chopping output (X-Power)	kW/hp	487 / 662	550 / 748	632 / 860	818 / 1112
sustained Eco Power chopping output	kW/hp	368 / 500	401 / 545	459 / 624	459 / 624
Tank capacity	Litres	1,100 / 1.500 as an option			
SCR tank capacity	Litres	150			
Silage additive tank (small dose rate)	Litres	275 / 505 option / 2 x 13			
Ground drive					
Model		infinitely variable hydrostatic drive with wheel motors for up to 40km/h			
Speed in field mode	km/h (mph)	0 - 25 (0 - 15.5)			
Speed in road mode	km/h (mph)	0 - 40 (0 - 24.9)			
Selectable anti slip control		Standard			
4WD		Optional			
Axles					
Steering angle on rear axle	Degrees	50			
Rear axle suspension		Hydraulic			
Drives					
Header		Infinitely variable			
Pre-compression rollers		Infinitely variable			
Pre-compression rollers					
Pre-compression roller throat volume		Funnel shaped			
Service position		Quick attach system (also with header attached)			
No. of rollers/metal detector/no. of magnet coils		6 / Series / 6			
Metal detector - counterblade distance	mm	820 (2'8")			
Chop length adjustment		steplessly from cab (0.5 mm increments)			
Chopping drum					
Drum width/diameter	mm	800 / 660 (2'7" / 2'2")			
Arrangement of blades		chevron style, at 11° to counterblade			
No. of blades		20, 28, 36, 40, 48			
LOC range		5-31 / 4-22 / 3-17 / 2.5-15 / 2-12			
Cuts per minute		12,500 / 17,500 / 22,500 / 25,000 / 30,000			
Stepless drum floor adjustment		Standard			
Spring-loaded drum floor		Standard			
Corn conditioner					
105 teeth: Saw tooth profile / chrome-plated		Option/Option			
123 teeth: Saw tooth profile / chrome-plated		Option/Option			
144 teeth: Saw tooth profile / chrome-plated		Option/Option			
166 teeth: Sawtooth profile		Optional			
144 teeth: X-treme, chrome-plated sawtooth profile		Optional			
105/123 teeth: X-treme, 30% speed differential		Optional			
Speed differential	%	20 / Optional 30/40			
Distance setting from the cab and coupling to central lubrication		Standard			
Roller diameter/clearance	mm	250 / 0.5 - 7.0 (10" / 0" - 0.3")			250/305 / 0.5 - 7 (10"/1' / 0" - 0.3")
Width	mm	710 (2'4")			

NEW

		BiG X 680	BiG X 780	BiG X 880	BiG X 1180
Crop accelerator					
Rotor diameter/width/no. of paddles		560 / 710 / 8			
Paddle arrangement		arranged chevron-style			
Speed	rpm	2,280			
Stepless adjustment of the backplate / Spring-loaded backplate		Standard			
Spout					
Angle of rotation	Degrees	210°			
Unloading height	m	6.00 (19'8")			
Cross-section dimensions	(cm)	34 x 23 (1'1" x 9")			
Automatic mirror function/parking position		Standard			
Rotary drive system		Gearboxes			
Spout lined with wear plates throughout		Standard			
Service & maintenance					
Auto lubricator with compressor		Standard			
Self-diagnosing system via operator terminal		Standard			
Cab¹⁾					
Air seat and buddy seat		Standard			
Comfort air seat and buddy seat		Optional			
Climate control / with mobile cool box		Standard / Option			
Windscreen wipers on front and sides/ Rear wiper / 3 side wipers		Standard / Option			
Dimensions					
Length/width*height*	m	7.50 - 8.25 / 3.20 - 3.50 / 3.90 - 3.98 (24'7" - 27'1" / 10'6" - 11'6" / 12'9" - 13'1")			
Base machine weight (without header)**	Approx. t	16.70	16.70	16.90	17.10
Weight distribution with EasyFlow 300 pick-up	F/R %	57 / 43			
Weight distribution with EasyCollect 750-3 (7.50m ww)	F/R %	60 / 40			
Tyres***					
Front axle	Standard****	680 / 85 R32			
	Optional	710 / 75 R42			
	Optional	710 / 70 R42			
	Optional	800 / 65 R32			
	Optional	800 / 70 R38			
	Optional	900 / 60 R32			
Rear axle	Standard****	540 / 65 R30			
	Optional	620 / 70 R30			
	Optional	710 / 60 R30			
Headers					
EasyFlow pick-up:	m	3.00 - 3.80 (9'10" - 12'6")			
EasyCollect variable row width header	m	4.50 / 6.00 / 7.50 / 9.00 / 10.50 (14'9" / 19'8" / 24'7" / 29'6" / 34'5")			
EasyCollect variable row width header	m	6.00 / 7.50 / 9.00 (19'8" / 24'7" / 29'6")			
Autopilot and active ground contouring for EasyCollect	m	Optional			
XDisc: the direct cut head	m	6.20 (20'4")			

* Depending on tyre configuration ** Depending on level of specification*** Does not combine with every tyre**** Limited use depending on header used

All specifications, weights and dimensions do not necessarily comply with standard specifications and are therefore not binding.

1) Further options on request

Maschinenfabrik Bernard Krone

Perfect in every detail

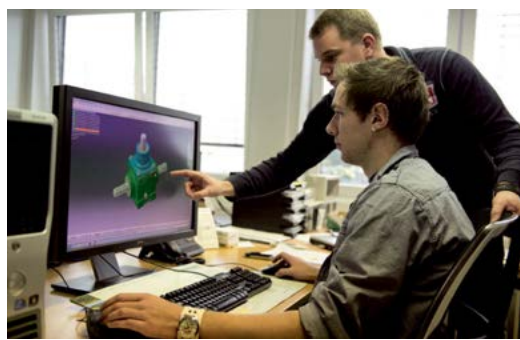

Innovative, proficient and close to our customers – these are the keywords that mark the philosophy of our family-owned company. As a forage specialist, KRONE manufactures disc mowers, tedders, rakes, forage wagons and silage trailers, round and square balers as well as the high-capacity and self-propelled BiG M mower conditioners and our BiG X forage harvesters. Quality made in Spelle – since 1906.

Your KRONE dealer



Maschinenfabrik Bernard KRONE GmbH & Co. KG

Heinrich-Krone-Straße 10
D-48480 Spelle

Phone: +49 (0) 5977 935-0
Fax: +49 (0) 5977 935-339

info.ldm@krone.de | www.krone.de