

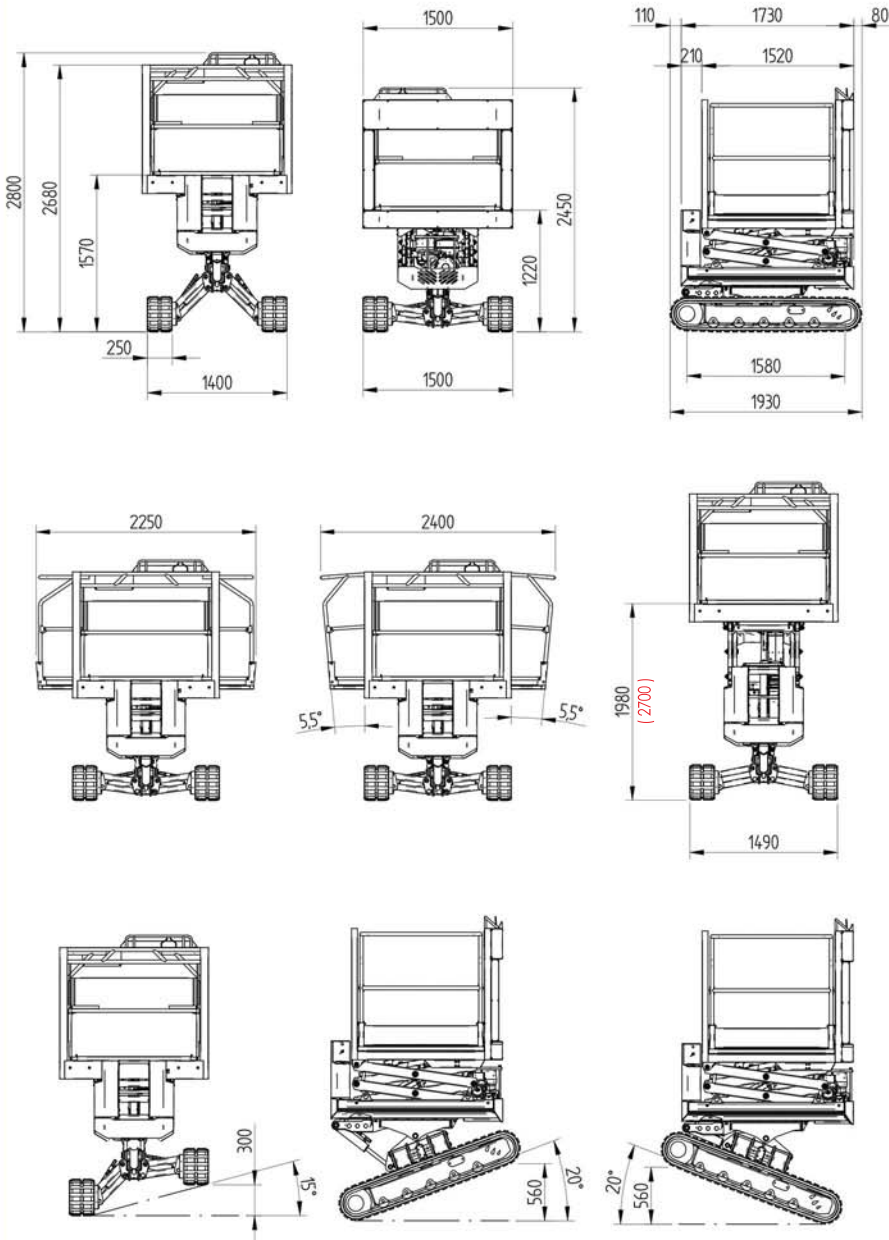





equipaggiamento di serie





 **Max 400Kg (2 persone + 240Kg)**
Max 400Kg (2 people + 240Kg)

 **13HP Honda iGX390 - Benzina**
13HP Honda iGX390 - Gasoline

 **Comandi idraulici a leve**
Hydraulic control levers

 **Contaore digitale**
Digital hour meter

 **Inclinometro elettronico (5°)**
Digital inclinometer (5°)

 **Generatore corrente 220V-1000W**
Power generator 220V-1000W

 **Piattaforma con doppio accesso per carico e scarico BIN**
Platform with double access for loading and unloading BIN

 **Doppia estensione laterale con ringhiera inclinabile**
Double lateral extension with railing tilttable

 **Livellamento longitudinale (40°)**
Longitudinal levelling (40°)

 **Livellamento Laterale (32°)**
Lateral levelling (32°)

Peso Complessivo (Total Weight) 1650 Kg

SAFETY LIFT GmbH

Hohenlimburger Str. 118 • 58093 Hagen
Tel.(02334) 441 200 • Fax.(02334) 441 326

ALMAC S.r.l.

Via Caduti Sul Lavoro, 1
46019 Viadana (Mantova) - ITALY

Phone +39.0375.833.527

info@almac-italia.com www.almac-italia.com