



Tractor people

TTR

THE
ERGIT100
SERIES

ERGIT 100: A NEW TRACTOR CONCEPT

Antonio Carraro SPA produces specialized tractors for professionals wishing to experience the emotion of owning something unique and precious that is guaranteed by a one-hundred-year-old brand at the cutting-edge of "Italian Style".



The Ergit 100 series is a new tractor concept. It is the outcome of a construction philosophy based on engineering simplification and the selection of top quality components; factors that allow the company to give these models a 2-year warranty. The care taken in design assures a pleasant and relaxed driving experience. It is not only attractive, but also performance enhancing as it allows for total operator visibility in all directions and ease when working in small spaces. The engines, with power outputs from 70 to 100 hp, offer exceptional torque and power levels combined with lower fuel consumption. The bodywork is painted with environmentally-friendly hydrosoluble enamels. Each technical solution is the result of choices that are based on socio-environmental benefits in terms of reduced pollution and noise levels.



THE
ERGIT 100
SERIES



TTR: the extralarge super-specialist



Mountain pastures, hillsides, flat country, sloping vineyards and orchards, embankments, urban parks, sports fields - football, horse-riding and golf, etc. - wherever there are steep slopes or grass cutting to be done, **TTR** is a super-specialist in its category. Its working speed, maneuvering precision and performance on slopes is impressive. TTR's stability is peerless thanks to the width of its wheel track, its very low center of gravity and the 4 equal driving wheels with wide treads, which, together with an exceptionally powerful engine, constant traction and reduced turning radius, allow this vehicle to adapt to all terrains and cope with the steepest of gradient and uneven ground, in all conditions and climates, through the entire year. Its reversible driving system, multi-function joystick and extraordinary visibility highlight its ergonomics, simplify work and reduce operator fatigue.



DESIGN
TECHNOLOGY
INNOVATION

MULTI-FUNCTIONALITY: all-in-one

The use of TTR can be changed thanks to the integrated lifting, hydraulic system, and PTO assembly. All of which make it possible to rapidly interchange the towing or frontal equipment that can also be mounted together.



MANY TRACTORS IN ONE



Mower, excavator, loader, fork-lift, baler, sower, planter, tiller, reach mower, snow blower and blade, grass cutter, trailer, sprayer and shredder, are just some of the more common implements that can be used with the Ergit 100 series TTR tractors. The tires are interchangeable, as every type of terrain requires its own tire that can optimize tractor performance.



TRADITIONAL TRACTOR

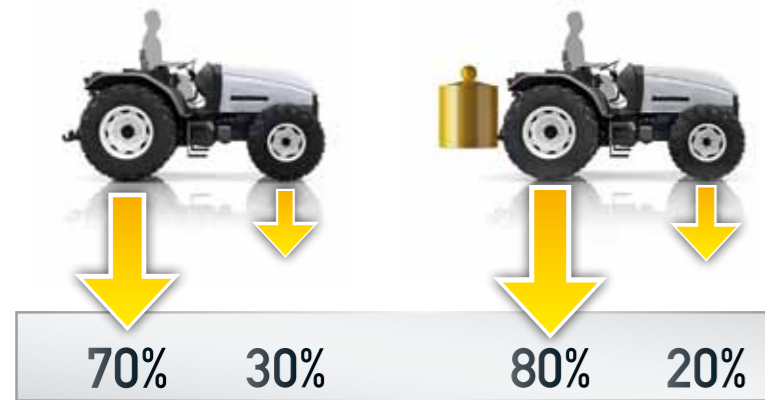

ACTRATOR

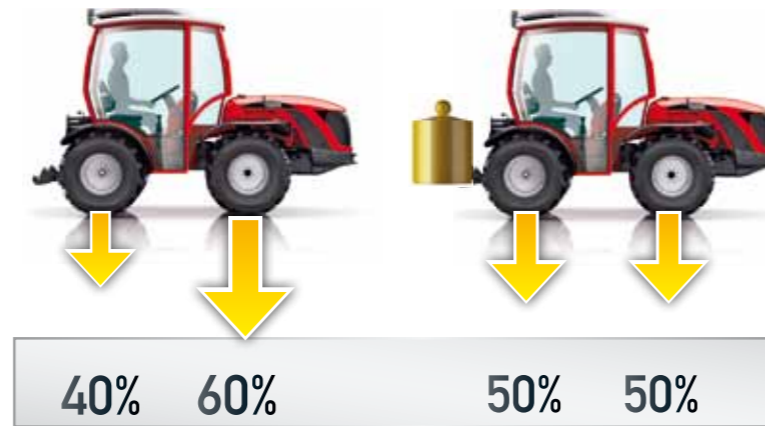

ACTIO™: the exclusive chassis designed by Antonio Carraro

ACTIO™, This Full Chassis with Oscillation is comprised of a solid cast-iron chassis fixed to the axles and housing the tractor transmission. It features a central joint with a longitudinal oscillation of up to 15°. The two oscillating ends follow the contour of the terrain independently, thus assuring stability and traction at all times. The constant adherence of the tires to the ground allows engine power to be entirely transferred to the ground, thus increasing performance and safety. The ACTIO™ chassis requires a "projecting" engine configuration in order to assure a low center of gravity and an equal division of the weight of the tractor: 60% on the front axle; 40% on the rear axle. This is an ideal balance with implements attached as it distributes 50% of the weight on each axle.

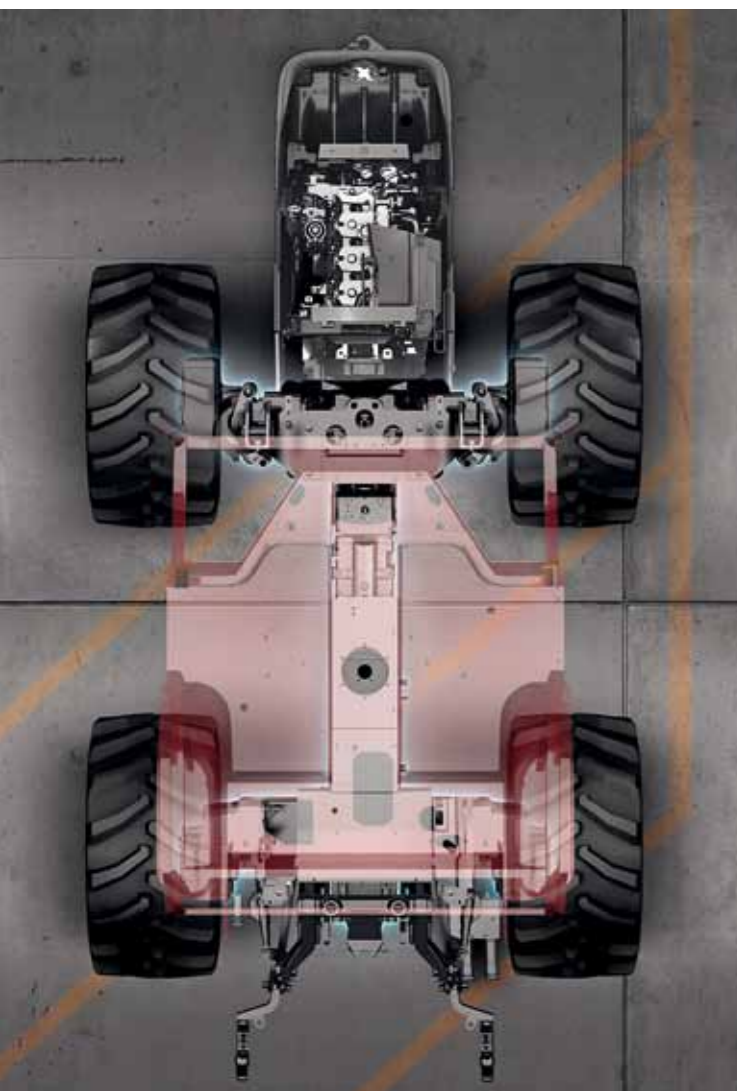

- + **Stability:** low center of gravity with 4 wheel drive
- + **Safety:** peace of mind
- + **Comfort:** driving position centered over chassis oscillation
- + **Agility:** short wheelbase and reduced turning radius
- + **Adherence:** equal division of weight
- + **Traction:** 4 drive wheels always firmly in contact with the ground

15°

RGS™: two sides of the same coin



RGS™ Rev-Guide System, is the AC reversible driving system on a rotating turret which inverts the driving direction in just a few seconds in order to work efficiently with towed or frontal equipment. Simply turn the seat/steering wheel/dash/pedal assembly 180° for an identical, but reverse, driving direction. The Joystick device and all the auxiliary controls remain in an ergonomic position. The RGS™ system is an integral part of the tractor's multifunctional feature. It simplifies use and improves the precision and quality of performance.



- + **Comfort:** simple and intuitive RGS™ system without double controls
- + **Visibility of equipment:** driving position in the center of the vehicle, in both directions
- + **Versatility:** greater profitability of tractor



**VERSATILITY
CREATIVITY
SAVING**



Low center of gravity, constant contact, stability, efficient braking and protected driving position are just some of the "active" safety features not to mention the "passive" features, such as quality of components, design, and eco-friendly engines. The braking system is comprised of 4 hydraulically-controlled, self-adjusting disc brakes in an oil bath which assures emergency braking modularity and reliability even when the front axle is disengaged. The overall safety of the vehicle has allowed it be approved for speeds of up to **40 Km/h** (25 mph). The lift features hydropneumatic suspension, which optimizes adherence of the tractor, such that it always stays "glued to the ground". The vehicle and its equipment follow the contour of the terrain without slipping or sliding sideways, assuring maximum performance. The electro-hydraulically controlled differentials lock at the rear and the front and rear in order to prevent slippage and assure that the tractor tires always have traction. The driving position is located at the center of the vehicle and features chassis with 6 uprights or cab approved to safety standards to ensure maximum operator protection.



AC TRACTOR

TRADITIONAL TRACTOR



SAFETY: active and passive

ERGONOMICS & COMFORT

The tapered and racy design helps the tractor to maneuver in fields and increases operator visibility of the equipment and the surrounding terrain. The driving position is particularly large and spacious, and all the controls are arranged in a logical sequence. The operating station is suspended on silent-block, which absorb vibrations and dampen noise.



Thanks to the ACTIO™ Chassis, the driving position coincides with the center of oscillation of the tractor. Sideways jerking and stress are very limited and operator fatigue is reduced, even after many hours. The on-board instrumentation is elegant, functional and intuitive: backlit anti-reflection screen for nighttime use; "on-off" information system; digital tachometer and PTO rev counter; and electro-hydraulic pushbutton controls.

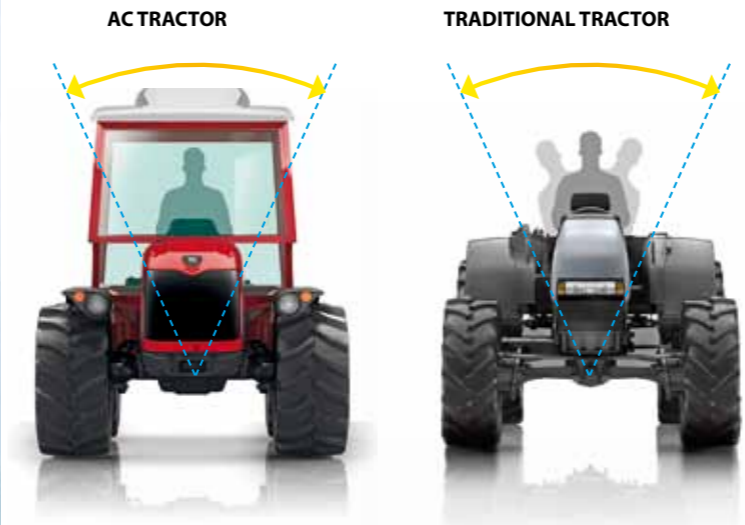
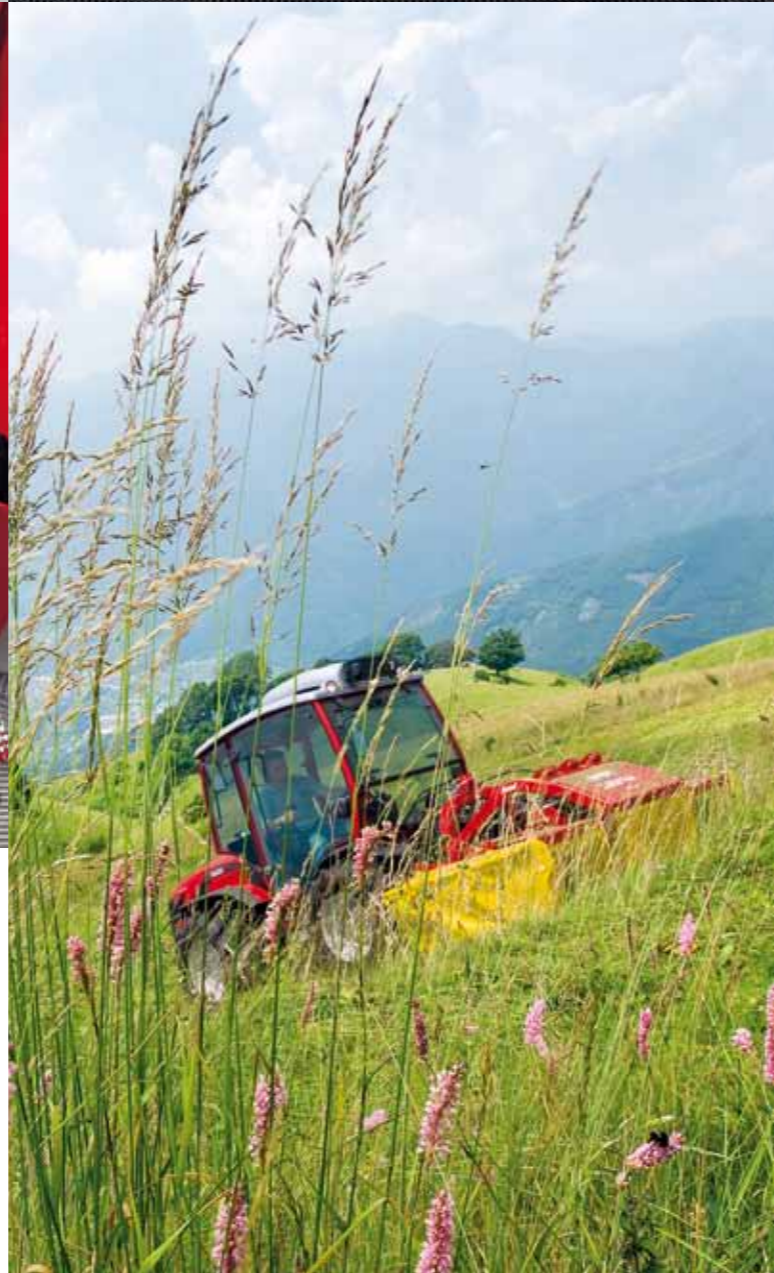

The lighting equipment, integrated into the mudguards, is comprised of reflecting parabolic optical assemblies, which offer a wide range of illumination covering the roadway, the equipment, and the surrounding field. Maintenance is practical and fast thanks to the fact that the bonnet can be fully opened and the side panels and battery cover can be easily removed.



+ Efficiency: Reduced fatigue & increased tractor performance

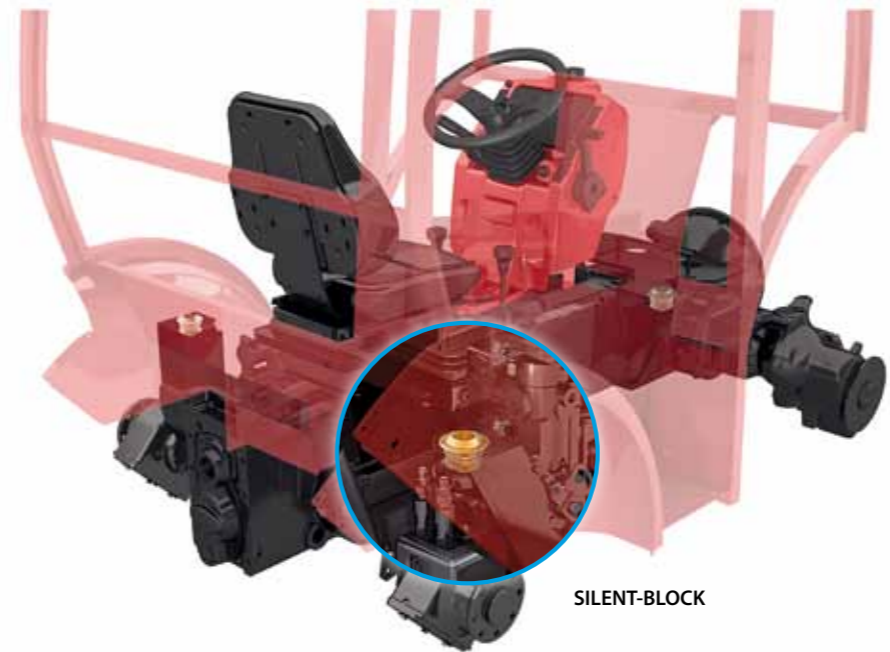

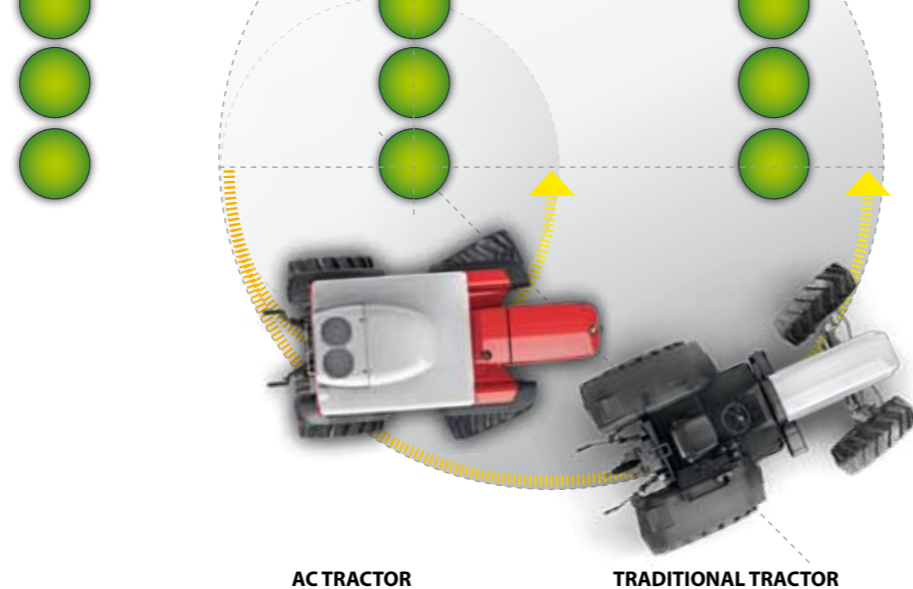

AC TRACTOR

TRADITIONAL TRACTOR

MACHINE AND EQUIPMENT: an integrated technological system

The integrated lifting - hydraulic system - PTO assembly can mount a large variety of implements at both the front and rear. The lift is a single group with vertical cylinders, featuring a 3-point hitch, a pump, and an independent hydraulic system. The lift features hydropneumatic suspension, which optimizes adherence of the tractor, such that it always stays "glued to the ground": machine and equipment follow the contour of the terrain without slipping or sliding sideways, assuring maximum performance.

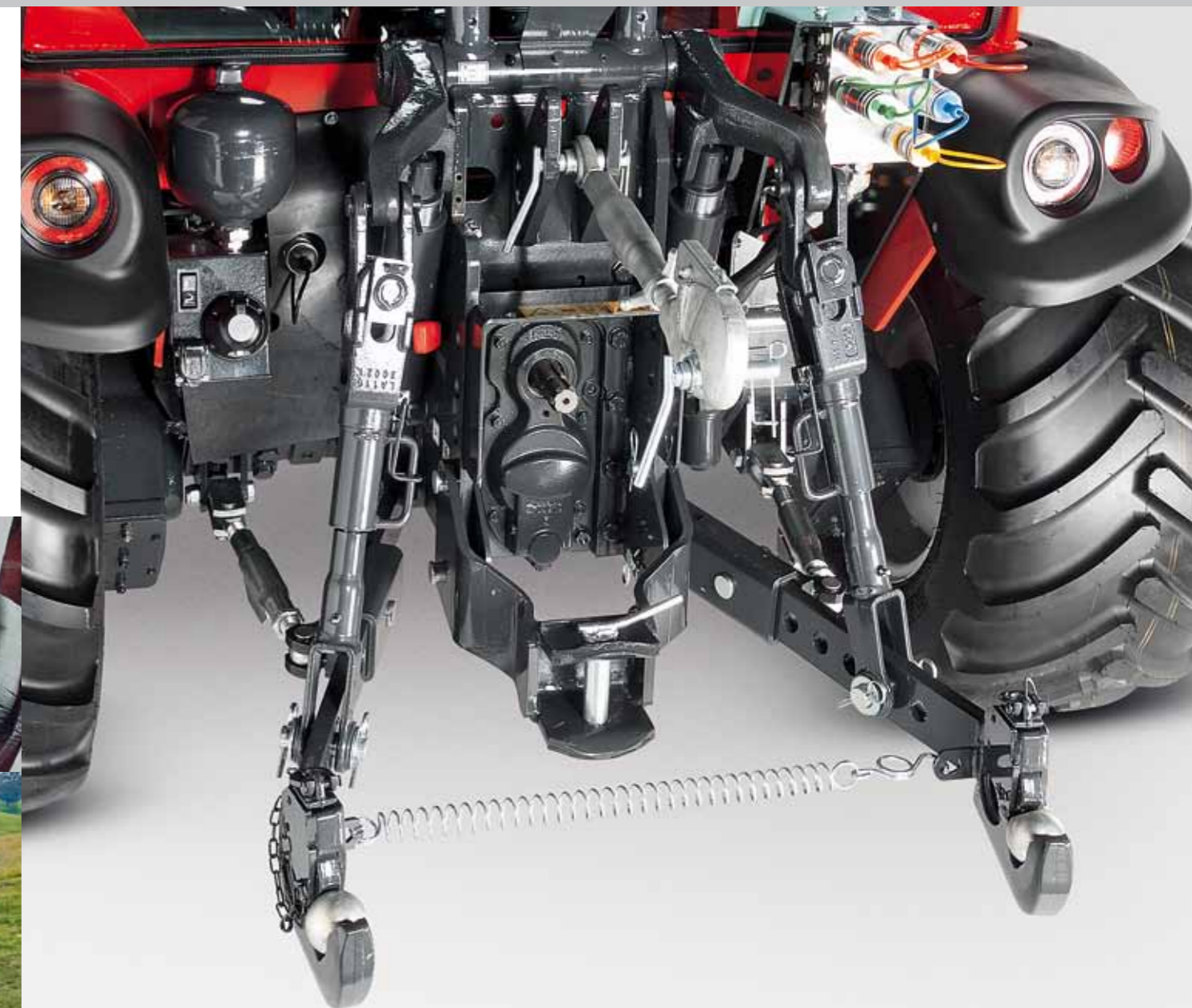

STEERING: precise and tight

**AGILITY
RAPIDITY
PRECISION**

The short wheelbase and tight steering radius make the tractor extremely agile in crop rows. To further reduce the turning radius, the steering brakes can be utilized, while accentuating the "superbend" effect obtained thanks to the double-acting constant velocity joints. The front wheel on the inside of the curve naturally increases the steering angle without the vehicle being allowed to stick. The smooth and sensitive hydroguide steering wheel assures precise maneuvering on steep slopes, in crossways movements, in narrow paths, among crop rows and in car parks.

PLUS

+ *Handiness: comfort*

The hydraulic hydroguide system is independent; powered by its own hydraulic pump and fitted with an oil-filtering system. The minimum internal turning circle is 1900 mm (75 in) while the external is 3500 mm (138 in).

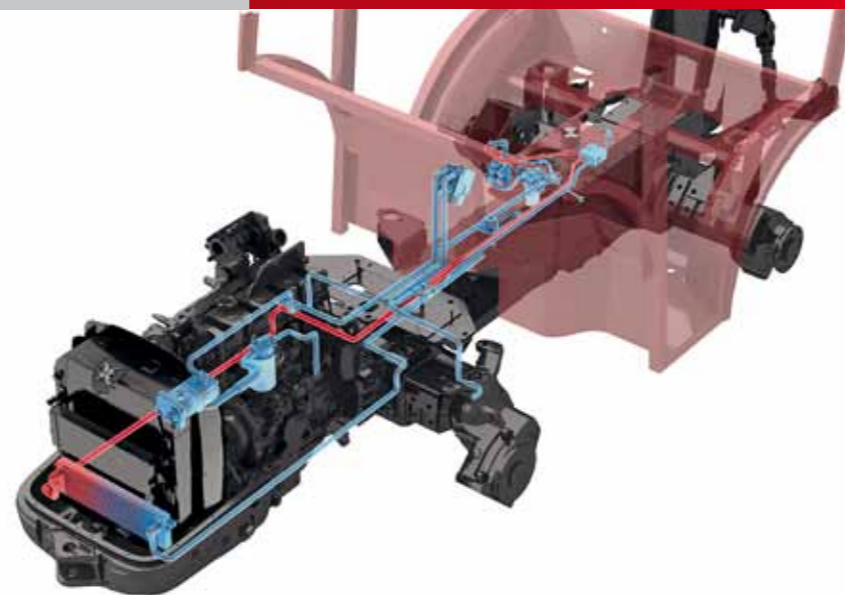



MACHINE AND EQUIPMENT: an integrated technological system

The front lift* optimizes combined work such as mower conditioner and rotary cutter, a front snow blade with a rear salt/sand spreader, or a shredder with a between-row mower. The clutch of the PTO with an electro-hydraulic progressive engagement command features a safety button for preventing involuntary starting and stopping the engine with the PTO engaged.



- + **Practicality:** engagement facilitated by the cardan shaft
- + **Two speed PTO :** fuel saving
- + **Comfort:** the PTO can be engaged while the tractor is moving
- + **Efficiency:** less heat build-up
- + **Multifunctionality:** hydraulic engines run at a constant speed
- + **Functionality:** engagement without stalling the engine
- + **Lifetime:** safeguard of PTO shaft
- + **Comfort:** less operator stress

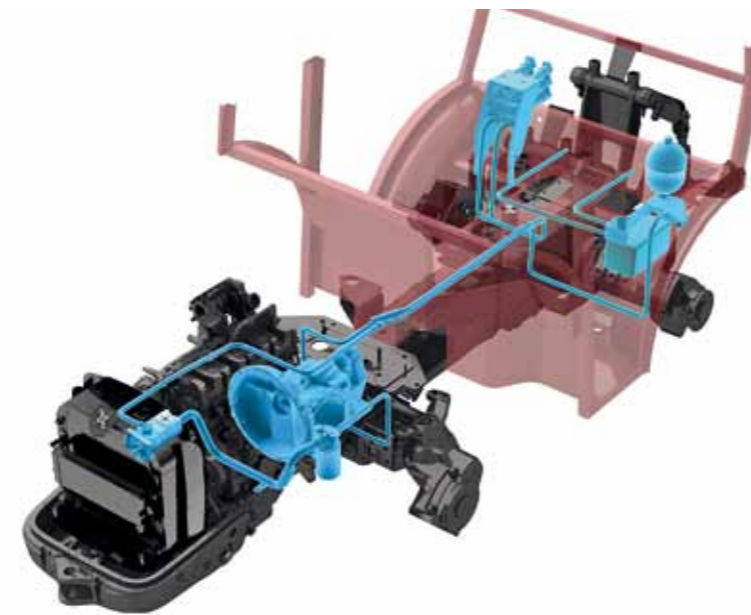

Vertical hydraulic tie-rod and 3-point hitch* allow adjustments to be made from the driver's seat.



The slider* tow hook with rapid vertical adjustment, is used to optimize the connection height of the towed equipment.



Hydraulic system with electro-hydraulic control with joystick: 2 double-acting manifolds, 1 single-acting, 1 oil return tap. Total: 6 rear quick-couplers.



Hydropneumatic suspension with automatic pressure control.



Two speed PTO: 540 rpm, 540 E (750 rpm) and synchronized with gear speeds. The PTO shaft of the ASAE 1 3/8 type is the same for all speeds.



The front lift* optimizes work combined with rear tools.



The front PTO* (1000 rpm) with electro-hydraulic controls and progressive engagement with safety button is maintenance free.



The rear differential lock prevents slipping and optimizes traction. The front traction disengagement is useful when travelling along roads and prevents damage from being done to delicate grounds.

*optional

CAB: "Extra Comfort"

This original and approved AC product, with a simple and elegant design, features a totalglass structure offering operators all-round visibility and unbeatable internal luminosity. This particularly spacious and comfortable cab assures maximum protection in the hot and dusty or cold conditions that are typical when cutting grass, maintaining roads or operating on worksites.

The "Extra Comfort" cab minimises noise and vibrations and provides an excellent quality of conditioned air to the operator. The glass surfaces can be opened. The uniform and well-distributed ventilation system gives the operator a sensation of well-being and serenity during work. The cabin is mounted on a platform suspended on silent-blocks.

COMFORT VISIBILITY SAFETY



The incoming air is cleaned by a large filter, with an available activated carbon filter*.



Easy access to the driving position with all-around visibility.



Cabin controls (windshield wipers, work lights, rotating beacon) in an ergonomic position, even when reversing.



The air-conditioning is achieved by a powerful system running on R134A ecological coolant, which also refreshes the cabin air using a low rev motor. The heating system utilizes a powerful heat-exchanger which is most exceptional even in the coldest weather.



Glove compartment.



Fitted for a car radio*.



*optional

TRANSMISSION AND GEARS: many speeds in a logical sequence



The tractors in the Ergit 100 series utilize large, extraordinarily reliable, smooth engaging clutches that do not require adjustment thanks to the hydraulic control, which recovers the play caused by wear over time. The gear has a helical profile: 32 speeds, 16 FW and 16 RV, with a synchronized inverter that can be engaged even when the tractor is moving. The small gap between one gear and the next assures operative continuity in all circumstances.

The electro-hydraulically controlled HI-LO* system can be engaged while the tractor is moving at any speed and can reduce the selected speed by 20%, thus obtaining a range of 32+32 speeds. It is comprised of two clutches packs, with sintered disks in an oil bath. The electro-hydraulic engagement of one clutch automatically disengages the other, as it is mechanically activated by a series of springs. This technical solution prevents the tractor from going into neutral with the engine switched off.

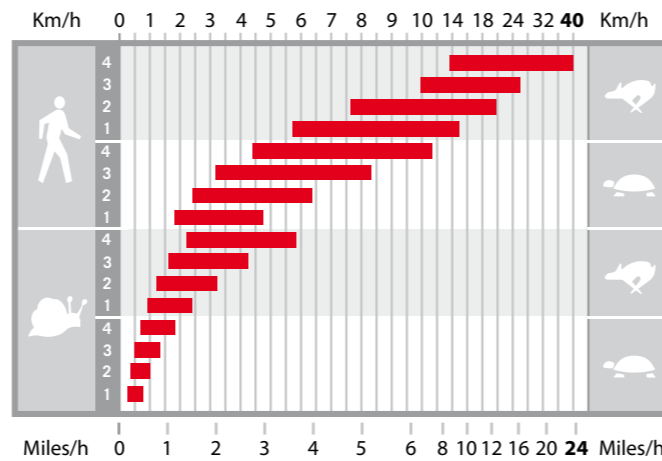

- + **Reliability:** long lifetime of the clutch
- + **Efficiency:** wide range of speeds
- + **Comfort:** smooth engagement without jerking the engine
- + **Saving:** lower fuel consumption and reduced running costs

N.B.: HI-LO not included on model 10400



ENGINE: powerful and quiet

TTR: 3 versions		
7800	9800*	10400*
71 HP	87 HP	95 HP
4 cylinders	4 cylinders turbo	4 cylinders turbo
3319cc	3319cc	2970cc
16 valves	16 valves	intercooler



The engines are at the top of their category and offer unbeatable torque and power performance as well as lower fuel consumption, lower noise, and lower carbon emissions. All the engines comply with "STAGE 3A" standards which limit the harmful emissions of diesel engines. Intercoolers, turbos, electronic EGR's, and multivalves, are utilized depending on the model of tractor. Thanks to this new generation of engines, the company has achieved new goals in terms of efficiency and cost-effectiveness.



- + **Reliability:** quality of components
- + **Performance:** maximum efficiency
- + **Comfort:** minimum vibrations, noise, and emissions
- + **Saving:**
 - € less maintenance costs
 - € rapid amortisation
 - € lower fuel consumption

* engines featuring balance shafts with injection systems and electronically-controlled EGR's.

MULTIFUNCTIONAL JOYSTICK: all functions at your fingertips

Multifunction Joystick

The Joystick is mounted standard on the right-hand reclining armrest of the driving seat. It allows operators to control all the functions of the single lift assembly and of the auxiliary hydraulic system using just one hand. The equipment raises, lowers and moves from side to side delicately and precisely.



- + *Ergonomic*: handy to use
- + *Comfort*: stress-free operation
- + *Saving*: reduction in cycle times

Hydropneumatic suspension

TTR has a maximum lifting capacity of 2400 Kg. The "hydropneumatic" suspension (transferring the weight of the equipment to the tractor tires) optimises the distribution of the weight of the tractor and equipment on all 4 wheels, as determined by the ACTIO™ chassis. It also keeps the weight of the equipment constant on the ground, regardless of the gradient, the difficulty of the terrain and the forward speed.

Auxiliary Hydraulic System

The Joystick is used to control all the hydraulic functions of the front and rear take-offs; it determines the continuous flow position for the use of hydraulic motors; it manages the single-acting manifold or the optional front lift, if fitted. The "push-pull" hydraulic take-off system facilitates rapid tool connection. Using equipment, such as the rear power shovel, loader, lift, baler, self-loading trailer and the like, the operator can work without having to remove his hand from the joystick which is fitted with a safety system to prevent accidental engagements and disengagements.



**GOVERNANCE
YIELD
HANDY**

OPTIONAL



BULLBAR

Tubular steel guard protecting the bodywork; integrates the third-point for the front lift.



FRONT LIFT

Used together with the bullbar, it allows all the frontal equipment to be used with multiple hydraulic connectors.



FRONT PTO

The front PTO (1000 rpm) with electro-hydraulic controls and progressive engagement with safety button is maintenance free.



HEADLIGHT GRILLES

Protecting the light assemblies, they also make the bodywork look more appealing.



SLIDER HOOK

Integrated into the rear lift, it gives the operator various options for the practical setting up of the tractor and the rapid alignment of the towed equipment.



VERTICAL TIE-ROD AND HYDRAULIC THIRD-POINT

Optimizes the positioning and inclination of the equipment.



FRONT BALLAST

Perfectly integrated into the bodywork of the tractor; it does not alter the wheelbase or dimensions of the tractor.



QUICK COUPLERS

Front lift with 1 double-acting manifold replicated at the rear. Total: 2 quick couplers.



HI-LO

HI-LO system which can be electro-hydraulically engaged when loaded thus reducing set speeds by 20% (64 speeds, 32 forward and 32 reverse) (except 10400).

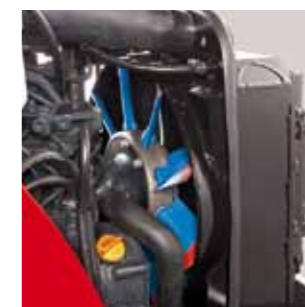

CLEAN FIX™ system

Reverse flow fan that assures the constant cleaning and efficiency of the radiator and of the front grille of the bonnet.



ESC (Electronic Speed Control)

Electronic and automatic speed and engine rev control device. It memorises and modulates the tractor speed at the operator's discretion.



PNEUMATIC SEAT

Latest generation air-suspension seat.

SAT: Customer Service Team



Antonio Carraro® Original Spare Parts and Assistance

The AC dealer network utilizes modern equipment and instruments that have been especially designed and built for maintenance work on AC tractors. The technicians at every authorized dealership periodically attend technical training courses at the Parent Company's facilities. Each authorized workshop employs highly qualified staff and provides an extensive range of services in order to offer its Customers maximum peace of mind and total protection. AC dealers can give their Customers information on all the services related to the care of AC tractors.



24 months of warranty

The experience gained during the years and the investments made in terms of materials and human resources have allowed Antonio Carraro to design and market the Ergit 100 Series with a standard 24 month warranty for the end customer. Customer satisfaction and safety is what counts most for Antonio Carraro. 24 months means giving Customers greater trust in what they have purchased and the certainty that they can count on a constantly available and highly qualified assistance service. A network of authorized dealers assures efficient and professional maintenance on tractors.

After-sales service

Thanks to the capillary network of dealers and the competence of the Service Managers, the Parent Company can assure all-around skills. With the right maintenance work, every AC tractor will continue to provide excellent performance throughout its operating lifetime.

Original Antonio Carraro Spare Parts

Original Antonio Carraro Spare Parts is a registered trademark. The elevated standards of design and the stringent tests carried out during the entire production process assure maximum quality levels. With Original AC Spare Parts, Customers can be certain of maintaining tractor performance unaltered over time, thus preserving the safety and the value of the tractor.

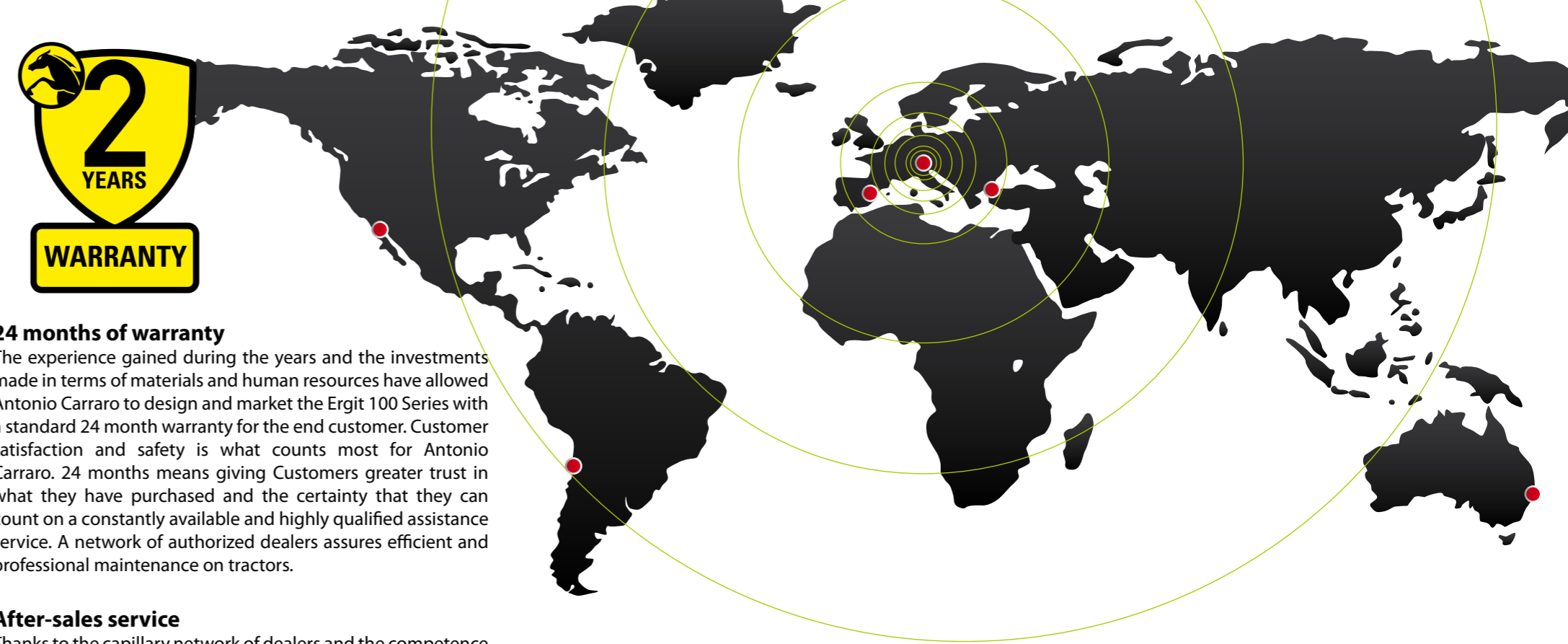

TECHNICAL DATA: TTR



Model	TTR 7800	TTR 9800	TTR 10400
Chassis	"ACTIO™" – Full chassis with oscillation • Reversibility RGS™ • Steering wheels • 4 equal wheel drive • Front and rear final drive		
Engine Type	Diesel direct injection with counter rotating weight system		
Emissions Regulations	Stage 3A	Stage 3A	Stage 3A
N° Cylinders	4-16 Valves	4-16 Valves - Turbo	4 Turbo - Intercooler
Displacement (CC)	3319	3319	2970
Power kW/HP (97/68/CE)	57/71	64/87	70/95
Maximum engine revs	2500	2500	2600
Torque max (Nm/revs)	236/1600	286,1/850	420/1000
Cooling	Water	Water	Water
Tank Capacity (litres/gal):	60/15.85	60/15.85	60/15.85
Transmission	Synchronized 32 speed gear box: 16 forward and 16 reverse with synchronized inverter		
PTO	Rear, independent and synchronized at 540/540E rpm with progressive electrohydraulic engagement		
Shaft	Profile 1" 3/8 with 6 splines with facilitated engagement		
Transmission clutch	Hydraulic control		
Drive disengagement	Electrohydraulic control on the front		
Rear hydraulic lift	With hydropneumatic suspension, joystick and 3-point hitch		
Operating Pressure (bar/psi)	160/2320		
Capacity (Kg/lbs)	2400/5291		
Steering	Hydraulic with 2 pistons		
Brakes	Standard: hydraulic front and rear disk brakes in oil bath, rear steering brakes Independent emergency and parking brake: band type on transmission		
Platform	Mounted on Silent Block with safety frame		
Weight in order of speed:			
With frame (Kg/lbs)	2150÷2340 / 4740÷5159	2150÷2340 / 4740÷5159	2090÷2180 / 4607÷4806
With cab (Kg/lbs)	2280÷2470 / 5026÷5445	2280÷2470 / 5026÷5445	2020÷2410 / 4453÷5313

Standard Features

- Reversible control tower • Rear or front/rear differential lock with electrohydraulic control • Hydraulic system with 2 separate hydraulic pumps • Adjustable steering wheel
- Adjustable lifting arms with quick release couplings
- Adjustable, suspension seat with safety belt • Rear hydraulic system with electro-hydraulic control with joystick: 2 double-acting manifolds, 1 single-acting, 1 oil return tap. Total: 6 rear quick-couplers • Rear adjustable height tow hitch • Front tow hitch • Multifunctional digital instrument Km/h and PTO • Battery • Electrical power point
- Safety starting device on the inverter and PTO

Optional Features

- HI-LO system which can be electro-hydraulically engaged when loaded thus reducing set speeds by 20% (64 speeds, 32 forward and 32 reverse) (except for 10400) • Extra Comfort cab with air conditioning system suspended on Silent Blocks • Support with 4 front ballast weights
- Hydraulic third hitch and vertical tie-rod with electro-hydraulic control • Front power lift • Front PTO 1000 rpm with electrohydraulic control • Pneumatic seat • Slider tow hitch • Rear oscillating tow bar • Front bullbar • Front lamp guards • Clean FIX™ > reverse flow fan for constant cleaning of the radiator and of the front grille of the bonnet
- ESC > Electronic Speed Control: electronic and automatic speed and engine rev control device. It memorises and modulates the tractor speed at the operator's discretion

DIMENSIONS TTR

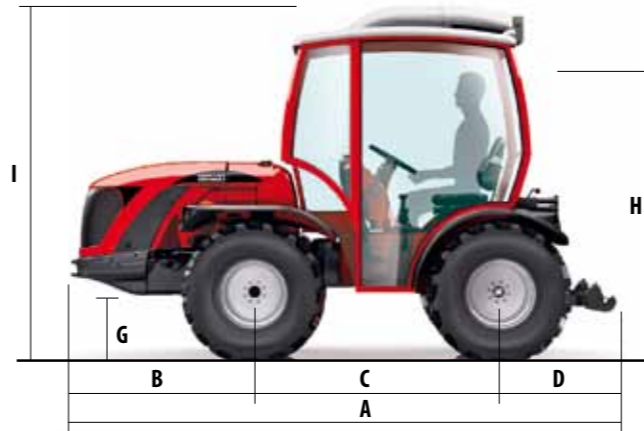

	E			
	31x15.50-15 Terra	31x15.50-15 Softrac	31x15.50-15 Xtra-Trac	300/80-15.3
E	395/15.6	395/15.6	395/15.6	300/11.8
	340/65 R18	400/55-17.5 Terra Twin	440/50 R17 All-Ground	425/55 R17 AC 70 C
E	340/13.9	400/15.7	440/17.3	425/16.7

Wheels

Dimensions (mm/inch)

Front/Rear	A	B	C	D	F	G	H**	I	L*	M	N*	O
31x15.50-15 Terra	3500/137.8	1220/48.0	1530/60.2	750/29.5	2085/82.1	310/12.2	1865/73.4	2215/87.2	1835/72.9	1440/56.7	1835/72.2	1440/56.7
31x15.50-15 Softrac	3500/137.8	1220/48.0	1530/60.2	750/29.5	2085/82.1	310/12.2	1865/73.4	2215/87.2	1835/72.9	1440/56.7	1835/72.2	1440/56.7
31x15.50-15 Xtra-Trac	3500/137.8	1220/48.0	1530/60.2	750/29.5	2085/82.1	310/12.2	1865/73.4	2215/87.2	1835/72.9	1440/56.7	1835/72.2	1440/56.7
300/80-15.3	3500/137.8	1220/48.0	1530/60.2	750/29.5	2130/83.8	355/14.0	1910/75.2	2260/89.0	1610/63.4	1310/51.6	1610/63.4	1310/51.6
340/65 R18	3500/137.8	1220/48.0	1530/60.2	750/29.5	2130/83.8	355/14.0	1910/75.2	2260/89.0	1740/57.9	1400/55.1	1740/57.9	1400/55.1
400/55-17.5 Terra Twin	3500/137.8	1220/48.0	1530/60.2	750/29.5	2130/83.8	345/13.6	1910/75.2	2260/88.6	1830/72.0	1430/56.3	1830/72.0	1430/56.3
440/50 R17 All-Ground	3500/137.8	1220/48.0	1530/60.2	750/29.5	2130/83.8	355/14.0	1910/75.2	2260/89.0	1820/71.6	1390/54.7	1900/74.8	1470/57.9
425/55 R17 AC 70 C	3500/137.8	1220/48.0	1530/60.2	750/29.5	2130/83.8	355/14.0	1910/75.2	2260/89.0	1815/71.4	1390/54.7	1895/74.6	1470/57.9

*Min. external width

**Height calculated with the operator of average height sitting (cm/in 175/68.9)



DEALER:

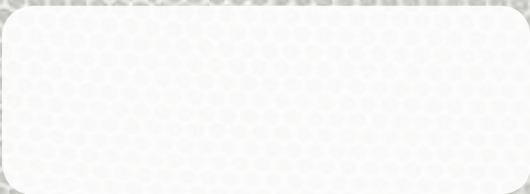

ANTONIO CARRARO SPA
Via Caltana, 24
35011 Campodarsego Padova ITALY
info@antoniocarraro.it
antoniocarraro.com

COD. 47318 131 - 12/2010